

ST-S800ES

SERVICE MANUAL

AEP Model
G-AEP Model

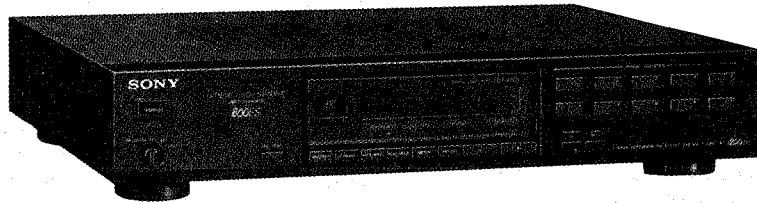

SPECIFICATIONS

FM tuner section

Tuning range	87.5 MHz - 108 MHz
Antenna terminals	75 ohms, unbalanced
Intermediate frequency	10.7 MHz
Sensitivity	16.8 dBf, 1.8 μ V (mono) 37.9 dBf, 22.5 μ V (stereo) at 50 dB quieting
Usable sensitivity	10.3 dBf, 0.9 μ V (IHF)
Signal-to-noise ratio	at 75 kHz deviation 97 dB (mono) 92 dB (stereo) at 40 kHz deviation 91 dB (mono) 86 dB (stereo)
Harmonic distortion at 1 kHz (at 75 kHz deviation)	WIDE: 0.005% (mono), 0.008% (stereo) NARROW: 0.04% (mono), 0.06% (stereo)
IM distortion	WIDE: 0.005% (mono), 0.008% (stereo) NARROW: 0.04% (mono), 0.06% (stereo)
Separation at 1 kHz	70 dB (WIDE) 50 dB (NARROW)
Frequency response	40 Hz - 12.5 kHz \pm 0.2 dB 15 Hz - 15 kHz \pm 0.5 dB
Selectivity	65 dB (NARROW) at 300 kHz 65 dB (WIDE) at 400 kHz
Capture ratio	1.0 dB (WIDE)
AM suppression ratio	65 dB

Image response ratio	120 dB
IF response ratio	More than 120 dB
Spurious response ratio	More than 120 dB
RF intermodulation	83 dB (800 kHz), 93 dB (2.4 MHz)
Muting threshold	29 dBf, 8 μ V
Auto tuning threshold	29 dBf
Output level/impedance at 75 kHz deviation	750 mV, 1 kilohm

— Continued on page 2 —

SAFETY-RELATED COMPONENT WARNING!!

COMPONENTS IDENTIFIED BY SHADING AND MARK  ON THE SCHEMATIC DIAGRAMS AND IN THE PARTS LIST ARE CRITICAL TO SAFE OPERATION. REPLACE THESE COMPONENTS WITH SONY PARTS WHOSE PART NUMBERS APPEAR AS SHOWN IN THIS MANUAL OR IN SUPPLEMENTS PUBLISHED BY SONY.

FM STEREO/FM-AM TUNER
SONY[®]



AUD

ST-S800ES

AM tuner section

Tuning range	531 - 1602 kHz
Antenna	AM loop antenna External antenna terminal
Intermediate frequency	450 kHz
Usable sensitivity	AM loop antenna 300 μ V/m (at 999 kHz) External antenna 30 μ V (at 999 kHz)
Signal-to-noise ratio	54 dB (50 mV/m)
Harmonic distortion	0.3% (at 50 mV/m, 400 Hz)
Selectivity	55 dB (9 kHz)

General

System	PLL quartz-locked digital synthesizer system FM stereo, FM/AM super-heterodyne tuner
Power requirements	220 V AC (or 240 V AC adjustable by authorized Sony personnel), 50/60 Hz
Power consumption	27 watts
Dimensions	Approx. 430 × 85 × 345 mm (w/h/d) (17 × 3 $\frac{3}{8}$ × 13 $\frac{3}{8}$ inches) including projecting parts and controls
Weight	Approx. 4.9 kg (10 lb 13 oz)
Accessories supplied	Ribbon antenna (1) Connecting cord (1) AM loop antenna (1) Antenna connector (1)

Design and specifications subject to change without notice.

FEATURES

Wave optimizer technology

The WOIS (Wave Optimized IF System) which makes the IF waveform optimum shape in stereo and monaural mode and the WODD (Wave Optimized Direct Detector) which forms the VCO oscillation waveform of the PLL detector ensure low distortion sound.

Direct comparator technology

An employed PLL IC allows the comparison frequency to be as high as the channel spacing frequency, thus eliminating the tendency of a low comparison frequency to slip into the audio range and degrade the signal-to-noise ratio.

Program function

Using the program function, you can automatically tune in up to four stations which have been memorized in any sequence you want. Stations will be received one by one as the power is turned on and off by an optional audio timer.

Two FM antenna connectors

Two FM antennas can be connected and selected with the front panel ANTENNA button. The multipath meter serves for orientating each antenna to the best direction against a particular FM station.

TABLE OF CONTENTS

<u>Section</u>	<u>Title</u>	<u>Page</u>
1. OUTLINE		
1-1.	Function of controls	3
2. DISASSEMBLY	4
3. ADJUSTMENTS	7
4. DIAGRAMS		
4-1.	Mounting Diagram	17
4-2.	Schematic Diagram (1)	21
4-3.	Schematic Diagram (2)	28
5. EXPLODED VIEWS	28
6. ELECTRICAL PARTS LIST	30

SECTION 1
OUTLINE

Front panel / Panneau avant / Vorderseite

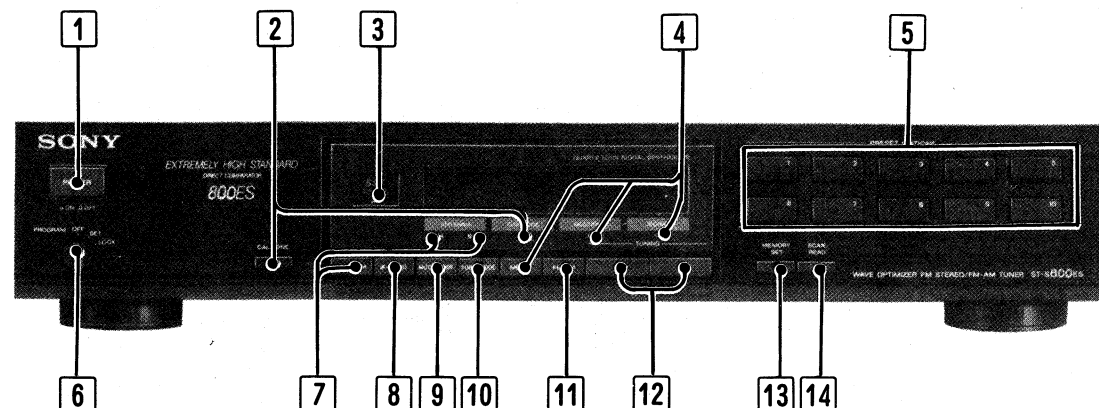

Display window / Fenêtre d'affichage / Display

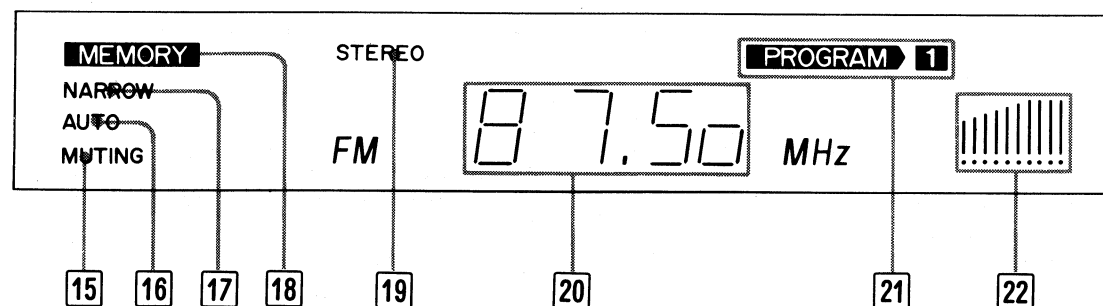

Rear panel / Panneau arrière / Rückseite

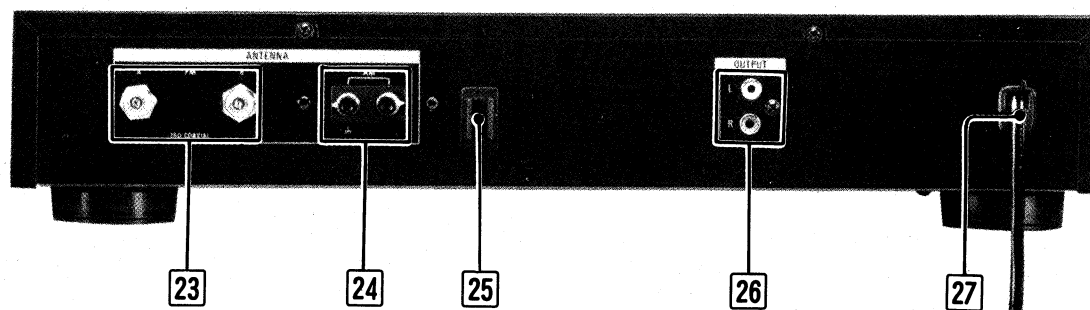

Each number is keyed to the descriptive text in "FUNCTION OF CONTROLS".

Chaque numéro trouve son correspondant dans le texte explicatif sous "FONCTION DES COMMANDES".

Die Nummern beziehen sich auf den Erläuterungstext des Abschnittes „FUNKTION DER BEDIENUNGSELEMENTE“.

1-1. FUNCTION OF CONTROLS

The numbers in illustrations on page 3 are keyed to the following explanations.

Front panel

- 1 POWER switch**
- 2 CAL TONE (calibrating tone) button and indicator**
Press this button to obtain a 400 Hz, 50% modulated signal for adjusting the recording level on a cassette deck. The indicator lights when a 400 Hz calibrating tone signal is provided.
To deactivate the cal tone circuit, press the button again.

- 3 SST (Super Sound Tracing) circuit indicator**
Lights when the SST circuit activates.

- 4 METER button and indicators**
Press this button to change the signal meter to the multipath meter. The MULTIPATH indicator lights. Press it again for the signal meter.

- 5 Station preset buttons and indicators**
Press the appropriate button to call up a memorized station.
The indicator of the called up station lights.

- 6 PROGRAM switch**
OFF: Normally, keep this switch in this position.
SET: Set the switch to this position for program function.
LOCK: When the PROGRAM switch is set to this position, only the POWER switch is operative in order to prevent malfunction.

- 7 ANTENNA button and indicators**
Press this button to select the FM antenna. Each time the button is pressed, antenna A (connected to the FM ANTENNA A connector) or B (connected to the FM ANTENNA B connector) is selected alternately. The selected antenna indicator lights.

- 8 IF-BAND button**
Press this button to select bandwidth of the intermediate frequency in FM reception.
Normally, set the button so that the NARROW indicator is not lit.

- 9 MUTE/MODE button**
Normally, set this button so that the MUTING indicator is lit (on).
This button activates as a muting switch and an FM mode selector.
Press this button. The MUTING indicator lights and the muting circuit is activated to eliminate interstation noise while tuning so that the FM station is received in stereo mode.
To tune in a very weak FM station, press this button again. The MUTING indicator goes out and the muting circuit is deactivated so that the FM station is received in monaural mode.

In this case, be sure to keep the sound level of the connected amplifier down to avoid speaker damage caused by interstation noise during tuning.

- 10 TUNE MODE button**
Automatic tuning: Press this button so the indicator lights.
Manual tuning: Press the button again so the indicator goes out.

- 11 FM/AM band selector**
Press the button to select the desired band.
The selected band is shown in the display.

- 12 TUNING buttons**
Press the - button to go to a lower frequency.
+ button to go to a higher one.

13 MEMORY/SET button

Setting of the PROGRAM switch	Function of the MEMORY/SET button
OFF	Works as a MEMORY button. Press this button to memorize the station by using the station preset button. The MEMORY indicator illuminates for seconds.
SET	Works as a PROGRAM button. Press this button to preset stations in the desired order. The MEMORY indicator illuminates for seconds.

14 SCAN/READ button

Setting of the PROGRAM switch	Function of the button
OFF	Works as a MEMORY button. Press this button to automatically scan stations memorized in the station preset button.
SET	Works as a PROGRAM button. Press this button to program stations received in order of seconds.

CONTROLS

Icons on page 3 are keyed to the following explanations.

- 10 TUNE MODE button**
Automatic tuning: Press this button so that the AUTO indicator lights.
Manual tuning: Press the button again so that the AUTO indicator goes out.

- 11 FM/AM band selector**
Press the button to select the desired band.
The selected band is shown in the display window.

- 12 TUNING buttons**
Press the - button to go to a lower frequency and the + button to go to a higher one.

- 13 MEMORY/SET button**

Setting of the PROGRAM switch	Function of the MEMORY/SET button
OFF	Works as a MEMORY button. Press this button to memorize the tuned station by using the station memory button. The MEMORY indicator illuminates for a few seconds.
SET	Works as a program SET button. Press this button to program the preset stations in the desired order. The MEMORY indicator illuminates for a few seconds.

- 14 SCAN/READ button**

Setting of the PROGRAM switch	Function of the SCAN/READ button
OFF	Works as a memory SCAN button. Press this button to automatically scan the stations memorized on the station preset buttons.
SET	Works as a program READ button. Press this button. The programmed stations are received in order for a few seconds.

Display window

- 15 MUTING indicator**
Lights when the MUTE/MODE button is pressed.
- 16 AUTO indicator**
Lights when the automatic tuning is performed by using the TUNE MODE button.
- 17 NARROW indicator**
Lights when the IF-BAND button is pressed to select the narrow band.
- 18 MEMORY indicator**
Lights for a few seconds when the MEMORY/SET button is pressed.
- 19 STEREO indicator**
Lights when an FM stereo program of sufficient signal strength is tuned in with the MUTE/MODE button pressed. (This indicator does not light when the MUTING indicator is gone out.)
- 20 Frequency display window**
Displays frequencies being received.
- 21 PROGRAM indicator**
Lights when the PROGRAM switch is set either to SET or LOCK.
The number of the programmed station being received is displayed.
- 22 Signal/multipath meter**
Select the meter with the METER button.
Signal meter: Indicates the signal strength of the station being received.
Multipath meter: Indicates the strength of multipath signals. Less meter segments light, better the reception is.

Rear panel

- 23 FM antenna connectors**
- 24 AM antenna terminals**
- 25 AM loop antenna holder**
Use this holder to install the supplied AM loop antenna on the rear panel.
- 26 OUTPUT terminals**
Connect to the TUNER input jacks of the amplifier.
- 27 AC power cord**

g tone) button and indicator
tain a 400 Hz, 50% modulated recording level on a cassette ts when a 400 Hz calibrating tone ne circuit, press the button again.

ing) circuit indicator
rcuit activates.

icators
ange the signal meter to the MULTIPATH indicator lights. gnal meter.

s and indicators
utton to call up a memorized led up station lights.

is switch in this position.
his position for program function.
GRAM switch is set to this position, itch is operative in order to prevent

l indicators
ect the FM antenna. Each time the nna A (connected to the FM) or B (connected to the FM) is selected alternately. The ator lights.

ect bandwidth of the intermediate ion.
n so that the NARROW indicator is

n so that the MUTING indicator is s a muting switch and an FM MUTING indicator lights and the ed to eliminate interstation noise FM station is received in stereo

FM station, press this button icator goes out and the muting t that the FM station is received in

keep the sound level of the wn to avoid speaker damage — **4** — noise during tuning.

SECTION 2
DISASSEMBLY

Note: Follow the disassembly procedure in the numerical order given.

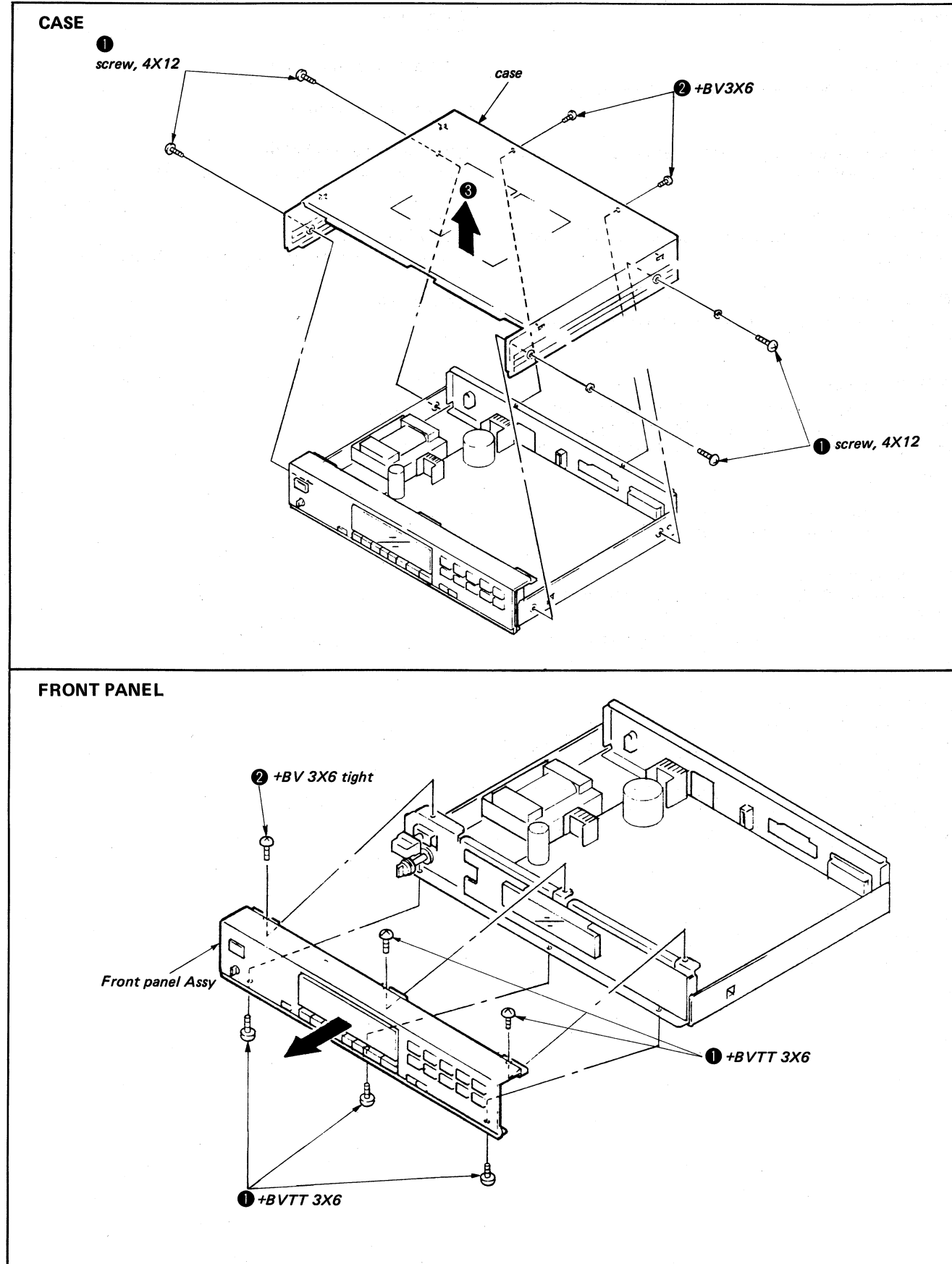

SECTION 3
ADJUSTMENTS

FM SECTION (1)

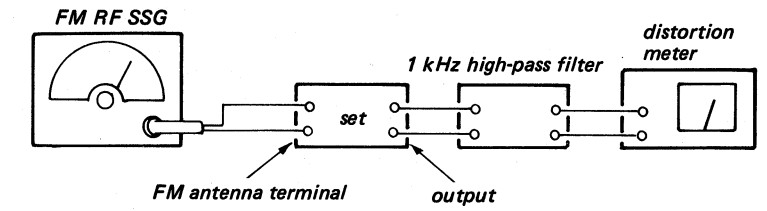

FM STEREO STANDARD SIGNAL	FM MONAURAL STANDARD SIGNAL
<p>Carrier frequency: 98 MHz Modulation: Audio 1 kHz, 16.25 kHz deviation (40.6%) Sub-channel 38 kHz, 16.25 kHz deviation (40.6%) Pilot 19 kHz, 7.5 kHz deviation (10%)</p>	<p>Carrier frequency: 98 MHz Modulation: 1 kHz, 40 kHz deviation (100%)</p>

SECTION 3
ADJUSTMENTS

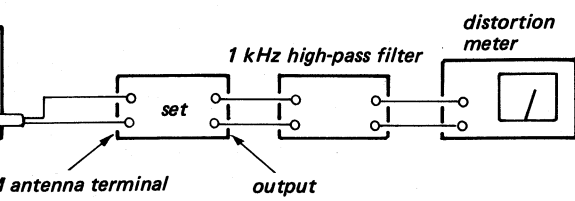

STANDARD SIGNAL	FM MONAURAL STANDARD SIGNAL
100 MHz Modulation: 1 kHz, 6.25 kHz deviation (40.6%) 19 kHz channel 38 kHz, 6.25 kHz deviation (40.6%) 19 kHz channel 19 kHz, 6.25 kHz deviation (10%)	Carrier frequency: 98 MHz Modulation: 1 kHz, 40 kHz deviation (100%)

[TUNER BOARD] (COMPONENT SIDE)

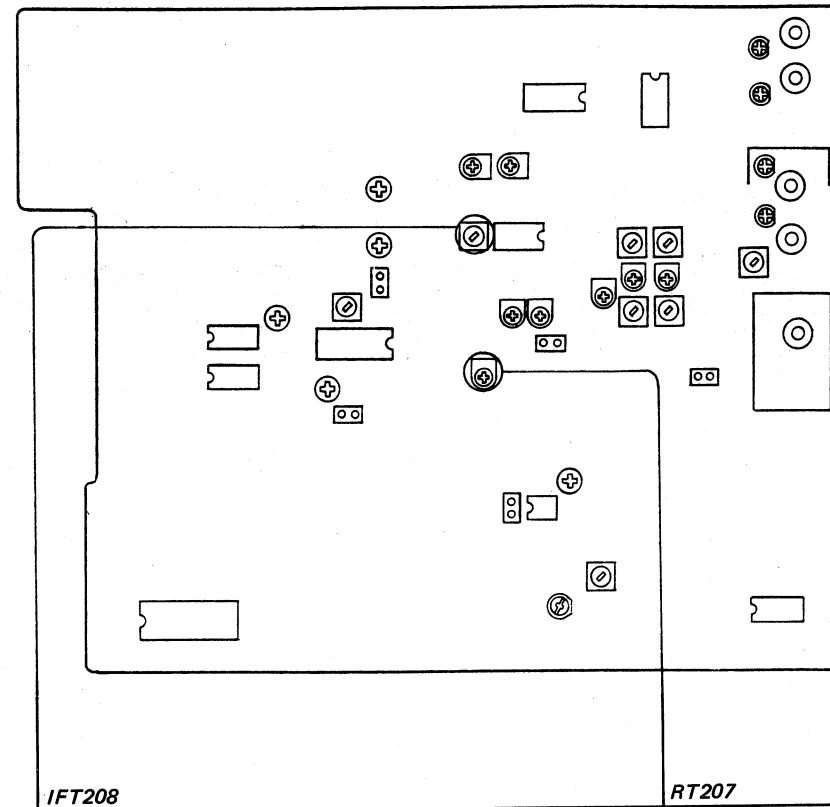

Muting Width Adjustment

Setting:
 IF BAND: WIDE
 MUTING/MODE switch: ON
 Receiving frequency: 98 MHz

Procedure:
 FM rf signal generator

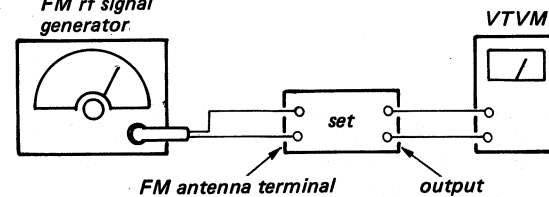

Carrier frequency: 98 MHz +50 kHz, -50 kHz
 Modulation: 1 kHz, 40 kHz deviation (100%)
 Output level: 10 mV (80 dB)

1. Increase the frequency of FM rf signal generator 50 kHz more than that of the receiving frequency and adjust IFT208 to obtain output.
2. Decrease the frequency of FM rf signal generator 50 kHz less than the receiving frequency and make sure to obtain output.
3. Repeat step 1 and 2, then adjust IFT208 to obtain output when increasing or decreasing the frequency of FM rf signal generator by the same amount.

Multipath Level Adjustment

Setting:
 IF BAND: WIDE
 METER: MULTIPATH

Procedure:

FM rf signal generator

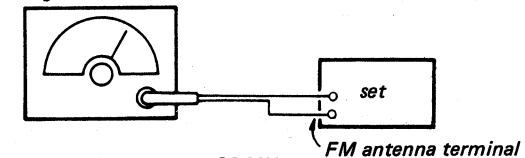

Carrier frequency: 98 MHz
 Modulation: No modulation
 Output level: 560 μV (55 dB)

1. Tune the set to 98 MHz by pushing the TUNING (+, -) button.
2. Adjust RT207 so that all signal elements 1 - 10 light up.

[TUNER BOARD] (COMPONENT SIDE)

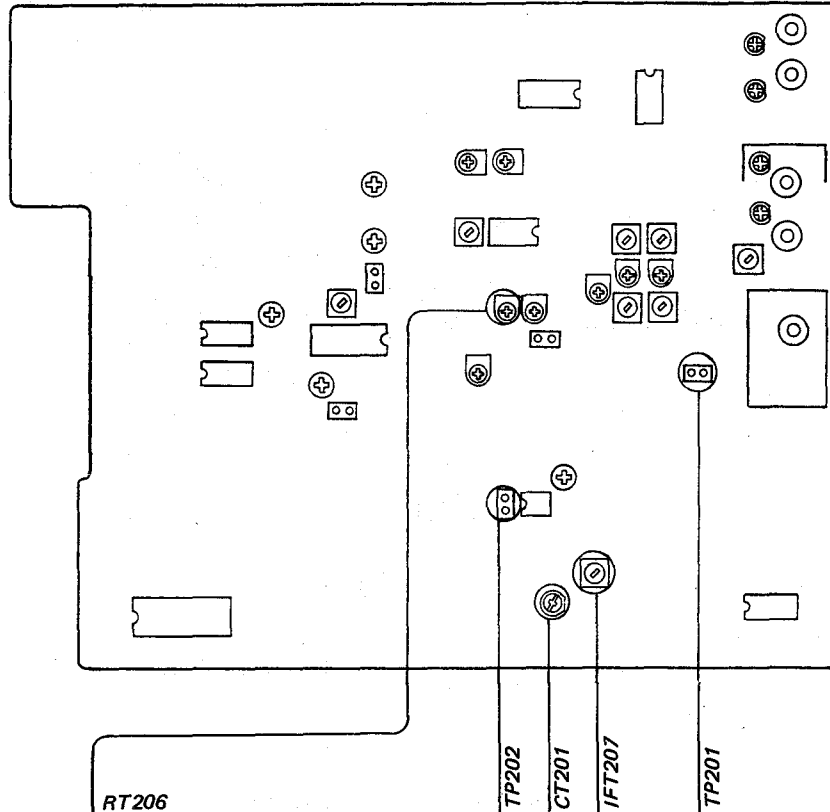

FM Muting Level Adjustment

Setting:

IF BAND: WIDE
METER: SIGNAL

Procedure:

FM rf signal generator

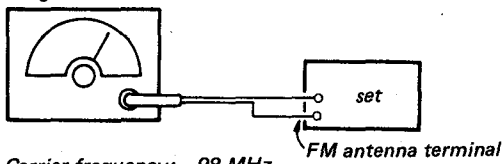

Carrier frequency: 98 MHz
Modulation: 1 kHz
Output level: 315 μ V (50 dB)

1. Tune the set to 98 MHz by pushing the TUNING (+, -) button.
2. Adjust RT206 so that all signal elements 1 - 10 light up.

Phase Locked Loop Detect Adjustment

Receiving frequency: 98 MHz
IF BAND: WIDE
MUTING/MODE switch: OFF

VOM (DC range)

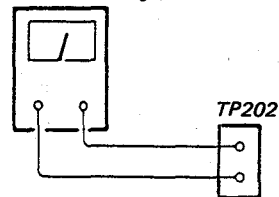

1. Short-circuit TP201 to the ground.
2. Set the FM rf signal generator output to 80 dB (μ V).
3. Adjust IFT207 for 0V reading on VOM (TP202).
4. Adjust CT201 for the minimum distortion ratio.
5. Repeat the step 3 and 4 several times.
6. Remove the short-circuit of TP201.

[TUNER BOARD] (COMPONENT SIDE)

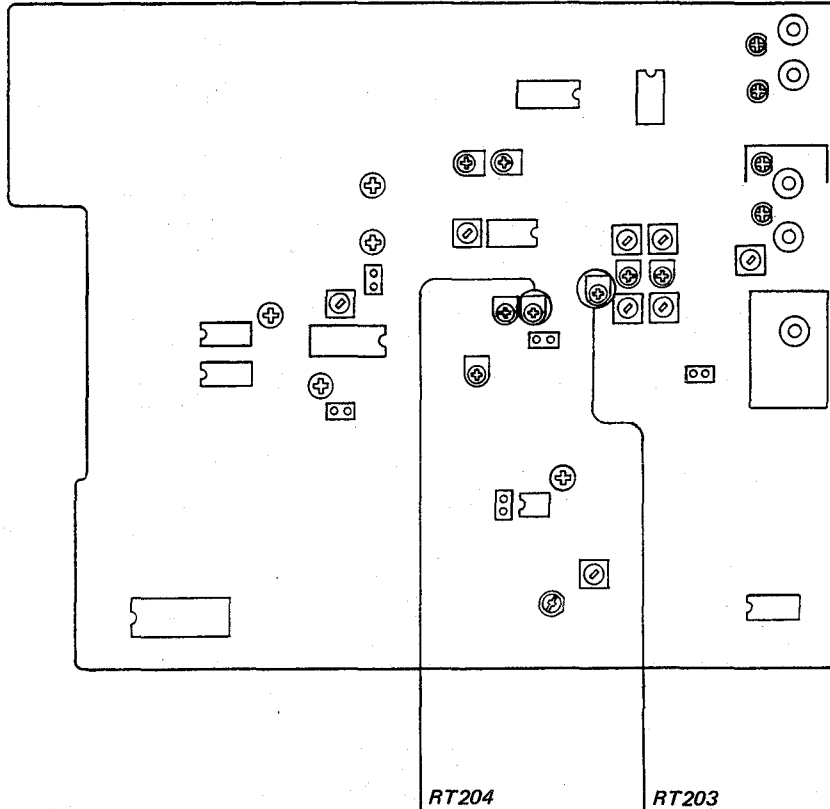

FM Muting Level Adjustment

Setting:

IF BAND: WIDE
MUTING/MODE switch: ON

Procedure:

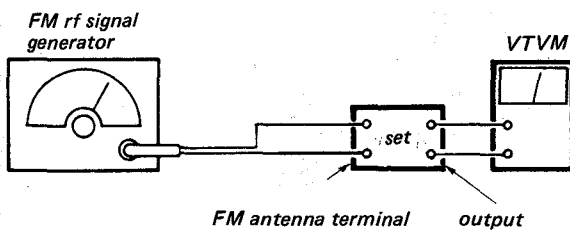

Carrier frequency: 98 MHz
Modulation: 1 kHz, 40 kHz deviation
Output level: 12.6 μ V (22 dB)

1. Tune the set to 98 MHz by pushing the TUNING (+, -) button.
2. Adjust RT204 for instantaneous 0 V reading on VTVM.
3. Mode: IF BAND NARROW
4. Adjust RT203 for instantaneous 0V reading on VTVM.

[TUNER BOARD] (COMPONENT SIDE)

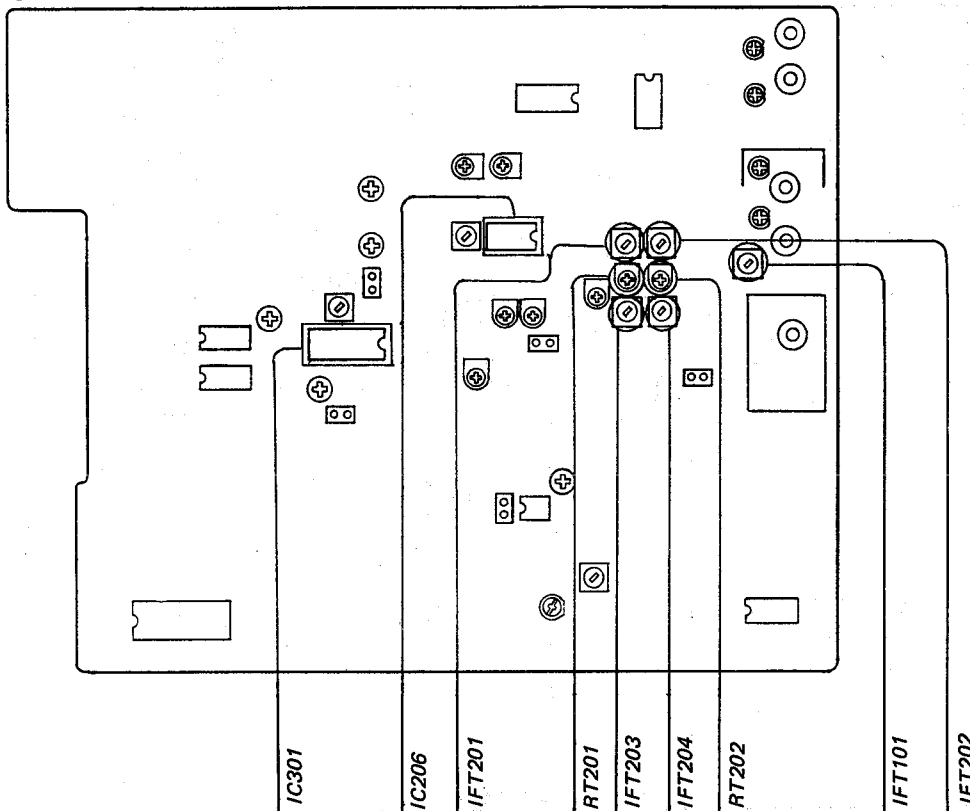

IF Distortion Adjustment

Setting:

Receiving Frequency: 98.0 MHz

IF BAND: WIDE

MUTING/MODE switch: OFF

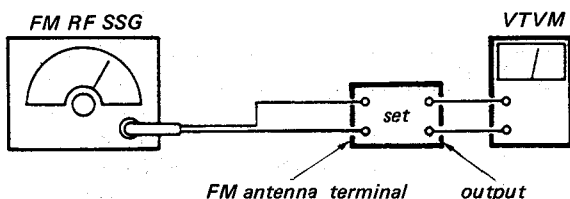

Procedure:

1. Turn RT201 and RT202 fully clockwise.
2. Set the signal generator (monaural) output to the weak (about 0 dB (μ V)) and put off the MUTING/MODE switch. Then adjust IFT101, IFT202 for the maximum reading on VOM.
3. Set pin 12 of IC301 to ground.
4. Adjust IFT101 for the maximum reading on VTVM.

5. Open pin 12 of IC301.
6. Set the signal generator output to 80 dB (μ V).
7. Turn RT201 and RT202 center.
8. Adjust IFT204 for the minimum distortion.
9. Set the signal generator output to 80 dB (μ V) at stereo modulation mode.
10. Adjust IFT203 for the minimum distortion.

[TUNER BOARD] (COMPONENT SIDE)

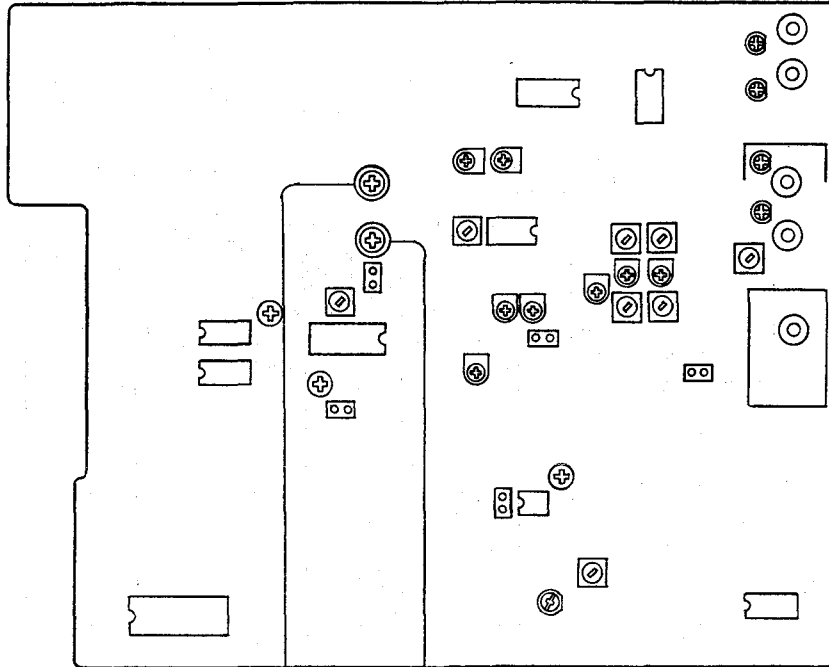

RT303

RT304

FM Stereo Separation Adjustment

Setting:

IF BAND: WIDE
MUTING/MODE switch: ON

Procedure:

FM rf stereo signal generator

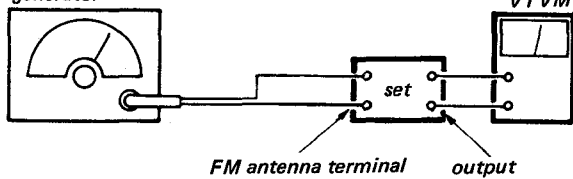

Carrier frequency: 98 MHz
Output level: 1 mV (60 dB)
Modulation: Audio 1 kHz,
16.25 kHz deviation (40.6%)
Sub-channel 38 kHz,
16.25 kHz deviation (40.6%)
Pilot 19 kHz, 7.5 kHz deviation (10%)

FM stereo signal generator output channel	VTVM connection	VTVM reading (dB)
L-CH	L-CH	(A)
R-CH	L-CH	(B) Adjust RT303 for minimum reading.
R-CH	R-CH	(C)
L-CH	R-CH	(D) Adjust RT304 for minimum reading.

L-CH Stereo separation: (A) - (B)
R-CH Stereo separation: (C) - (D)

The separations of both channels should be equal.

FM SECTION (2)

Pilot Cancel Adjustment

Setting:

MUTE/MODE switch: OFF

Procedure:

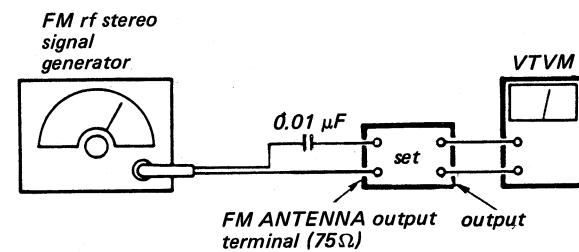

1. Tune the set to 98 MHz by pressing the TUNING (+, -) button and turn OFF the audio modulation of the FM rf stereo signal generator.
2. Adjust RT302 and L301 for minimum reading on the VTVM. Output level of both channels should be well balanced.

VCO1 Adjustment

Note: VCO1 adjustment should be made before the VCO2 adjustment.

FM rf signal generator.

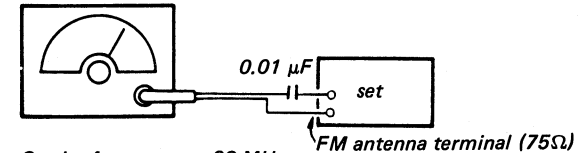

Carrier frequency: 98 MHz
Modulation: No modulation
Out put level: 1 mV (60 dB)

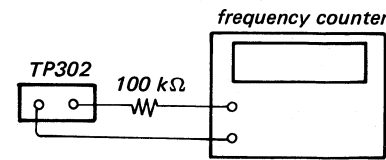

1. Adjust RT301 for 76 kHz \pm 100 Hz reading on the counter.
2. Perform VCO2 Adjustment

[TUNER BOARD] (COMPONENT SIDE)

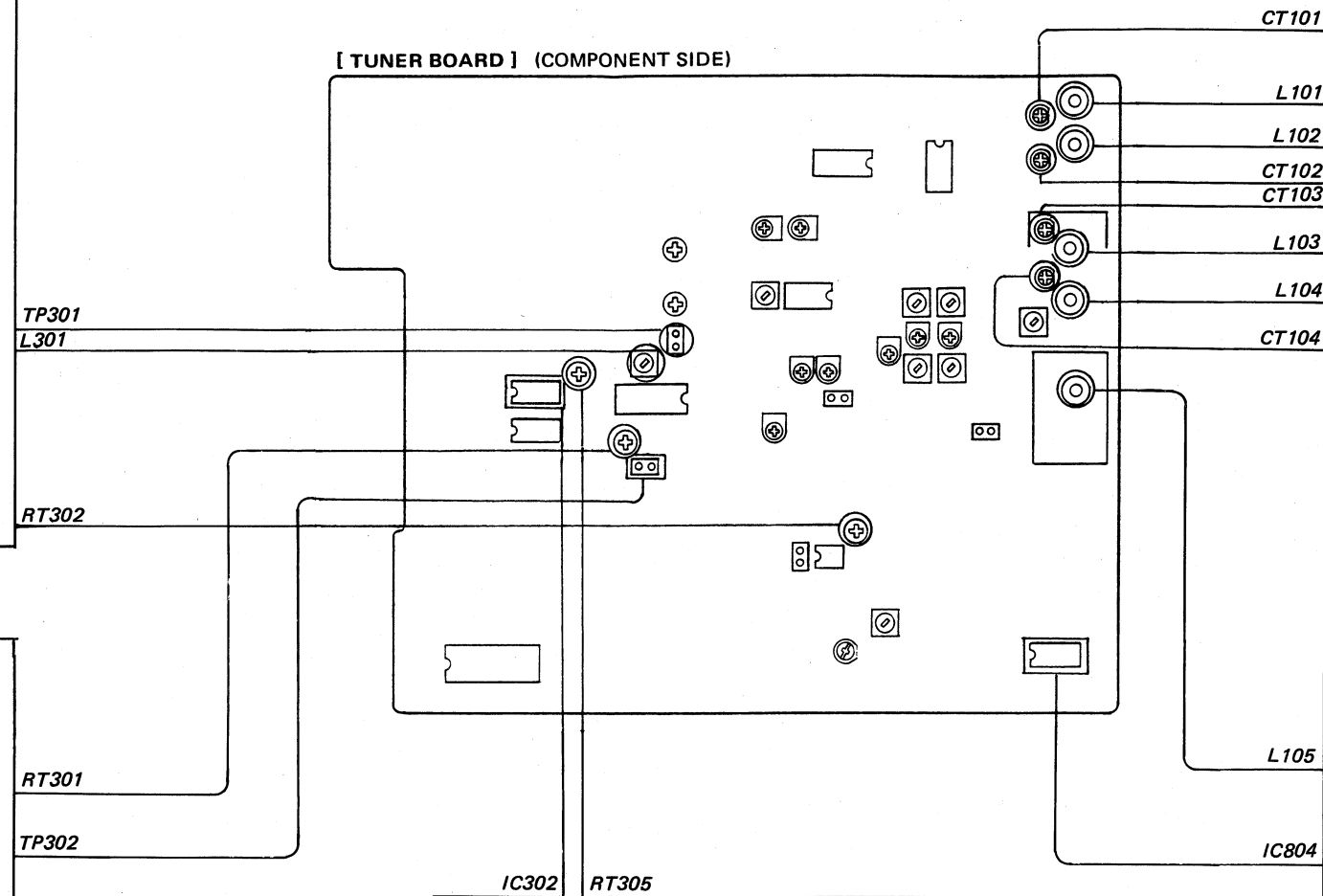

Tracking Adjustment

Note: Tracking Adjustment should be made after the Frequency Coverage adjustment.

Setting:

IF BAND: NARROW

Procedure:

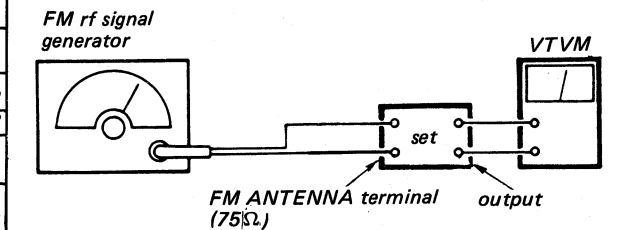

1. Tune the set to 108.0 MHz by pushing the TUNING (+, -) button.
2. Adjust CT101, CT102, CT103, and CT104 for a maximum reading on VTVM.
3. Tune the set to 87.5 MHz by pushing the TUNING (+, -) button.
4. Adjust L101, L102, L103, and L104 for a maximum reading on VTVM.
5. Repeat the steps from 1 to 4 several times.

VCO2 Adjustment

Note: VCO2 adjustment should be made after the VCO1 adjustment.

SSG Modulation: Pilot only

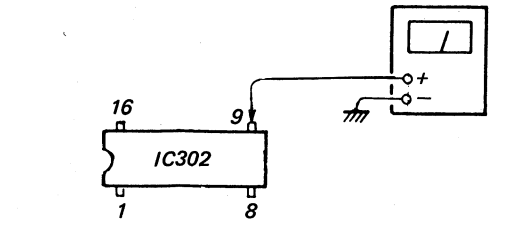

1. Adjust RT305 for 0V \pm 0.5V reading on VTVM.

Frequency Coverage Adjustment

1. Tune the set to 108.0 MHz by pushing the TUNING (+, -) button.
2. Adjust L105 for 21.0 \pm 0.2V reading on VOM.
3. Tune the set to 87.5 MHz by pushing the TUNING (+, -) button.
4. Check for 8.0 \pm 1.0V reading on VOM.

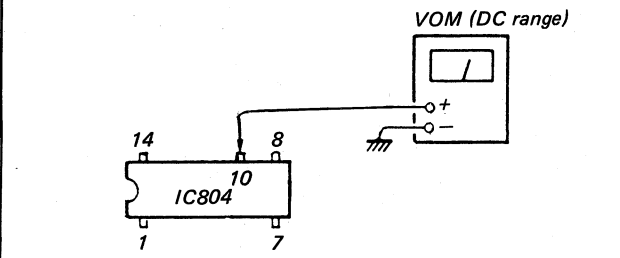

SECTION 4
DIAGRAMS

● SEMICONDUCTOR LOCATION

Ref.No.	Location	Ref.No.	Location	Ref.No.	Location
D101	A-16	IC201	B-17	Q101	C-15
D102	B-16	IC202	C-17	Q102	E-15
D103	D-16	IC203	H-17	Q103	G-15
D104	D-16	IC204	H-18	Q104	F-15
D105	F-16	IC205	D-19	Q105	G-16
D106	B-13	IC206	E-20	Q201	B-17
D201	A-17	IC207	B-18	Q202	B-17
D202	A-18	IC208	K-22	Q203	D-18
D203	H-18	IC209	I-20	Q204	G-17
D204	J-18	IC301	F-22	Q205	F-18
D205	J-19	IC302	F-24	Q206	G-17
D206	K-20	IC304	G-24	Q207	G-17
D207	K-20	IC305	D-24	Q208	J-19
D208	K-20	IC306	E-24	Q209	F-17
D209	E-17	IC307	C-24	Q210	G-17
D210	H-21	IC309	D-22	Q211	F-17
D211	K-22	IC311	C-22	Q212	D-17
D212	K-23	IC312	B-24	Q213	F-17
D213	J-23	IC314	B-23	Q214	G-18
D214	J-22	IC315	E-23	Q215	G-18
D301	F-21	IC316	D-23	Q216	C-18
D303	G-23	IC317	D-23	Q217	D-17
D305	A-23	IC318	G-25	Q218	D-18
D401	D-21	IC319	G-26	Q219	G-19
D402	F-20	IC401	B-19	Q220	D-19
D601	I-26	IC402	B-21	Q221	E-19
D602	F-21	IC501	H-15	Q222	F-19
D603	G-23	IC601	K-25	Q223	F-19
D604	I-26	IC602	H-24	Q224	H-20
D605	K-26	IC603	I-22	Q225	G-18
D606	K-26	IC701	G-7	Q226	G-20
D608	K-26	IC702	F-5	Q227	G-20
D610	J-26	IC703	G-7	Q228	G-19
D611	K-26	IC704	F-12	Q229	I-20
D612	J-26	IC705	G-4	Q230	K-20
D613	J-26	IC801	J-17	Q231	G-3
D614	H-25	IC802	I-17	Q232	D-17
D615	H-24	IC803	K-17	Q233	A-18
D616	H-23	IC804	K-16	Q301	G-24
D618	H-24	IC901	E-25	Q302	G-24
D622	I-26	IC902	B-25	Q303	G-24
D623	I-26	IC903	B-26	Q308	C-24
D624	J-22			Q309	C-24
D625	I-22			Q310	A-23
D626	K-24			Q312	E-23
D627	I-22			Q401	C-19
D701	F-9			Q402	D-19
D702	G-13			Q403	A-19
D703	F-13			Q501	I-16
D704	F-8			Q502	I-16
D705	F-9			Q503	I-16
D707	G-3			Q601	G-19
D708	G-9			Q602	G-20
D709	G-10			Q603	G-20
D710	G-11			Q604	H-23
D711	G-12			Q605	H-24
D712	G-13			Q606	H-24
D713	G-9			Q607	H-24
D714	G-10			Q608	H-25
D715	G-11			Q609	H-25
D716	G-12			Q610	F-20
D717	G-13			Q611	G-20
D718	F-6			Q612	F-20
D719	F-8			Q613	H-22
D720	F-5			Q615	I-25
D721	F-4			Q616	I-25
D722	F-5			Q617	J-23
D801	K-19			Q618	J-22
D903	D-25			Q619	J-22
D905	B-27			Q701	G-4
D906	C-27			Q702	G-4
D907	D-27			Q905	D-26

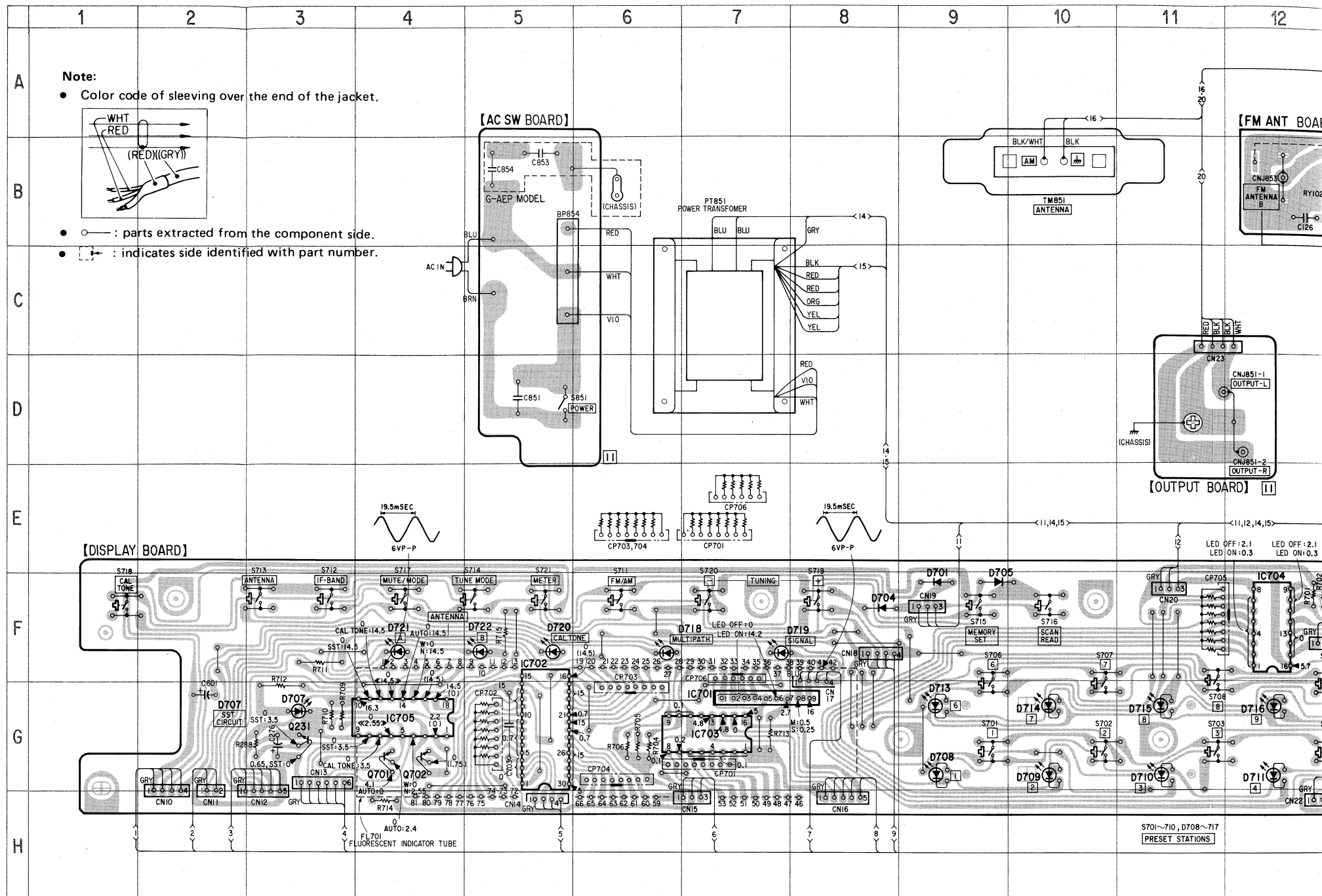

Semiconductor
Lead Layouts

CX7925 HD14013BP M4066BP TC4030BP μPC324C	LA5666 	M5238P NE5532P TA75558P	μPC577H 	μPC7915H 	2SA1175 letter side 	2SK152-3 	DSF1 	KV1320 anode 2 cathode anode 1 	SEL2410E-C SEL2810A-C long short anode cathode 	1T22A cathode anode
HD14027BP HD14046BP LA1235 SN74LS145N TC9174P	LB1290 	NJM78L08A NJM79L08A Ground Input Output 	μPC1163H 	DTA114ES DTA124ES DTA144ES DTC114ES DTC124ES DTC124XS DTC144ES 2SC634SP 2SC2603-F 2SC2724-C	2SC3622A-L 	2SK161-GR 	HZ5BLL HZ7A2L HZ30-2L 10E2N cathode anode 	MC921 	S1VB20 	
LA1245 20 18 16 14 12 19 17 15 13 11 1 2 3 4 5 6 7 8 9 10 	LB1493 	TD6301AN 	μPC1223C μPD6362C 	2SD774 	3SK74 3SK85 G2 G1 S D 	2SK30A-GR3 2SK125-3 2SK246-GR3 	KV1226 cathode 2 anode 2 cathode 1 anode 1 	MC931 	1SS132 cathode anode 	
		TMP47C40N-6308 	NJM7815A IN GND OUT 							

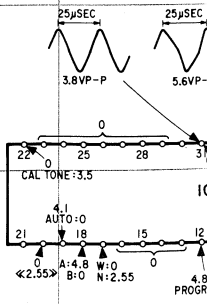

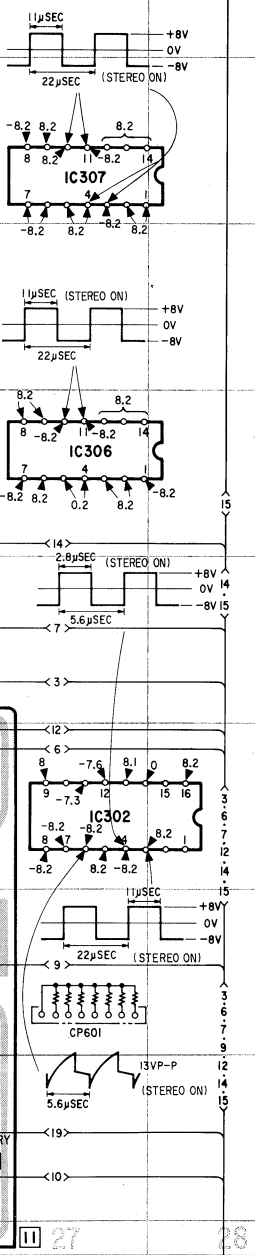
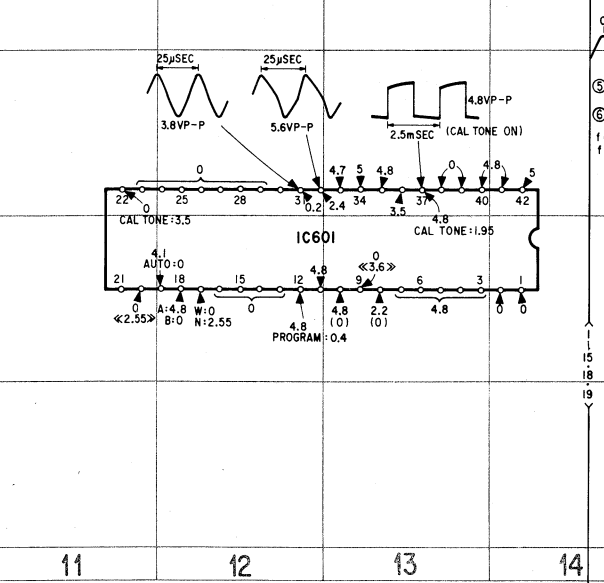
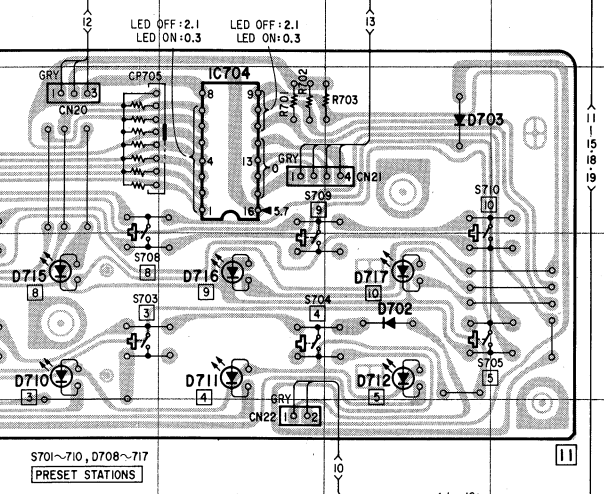
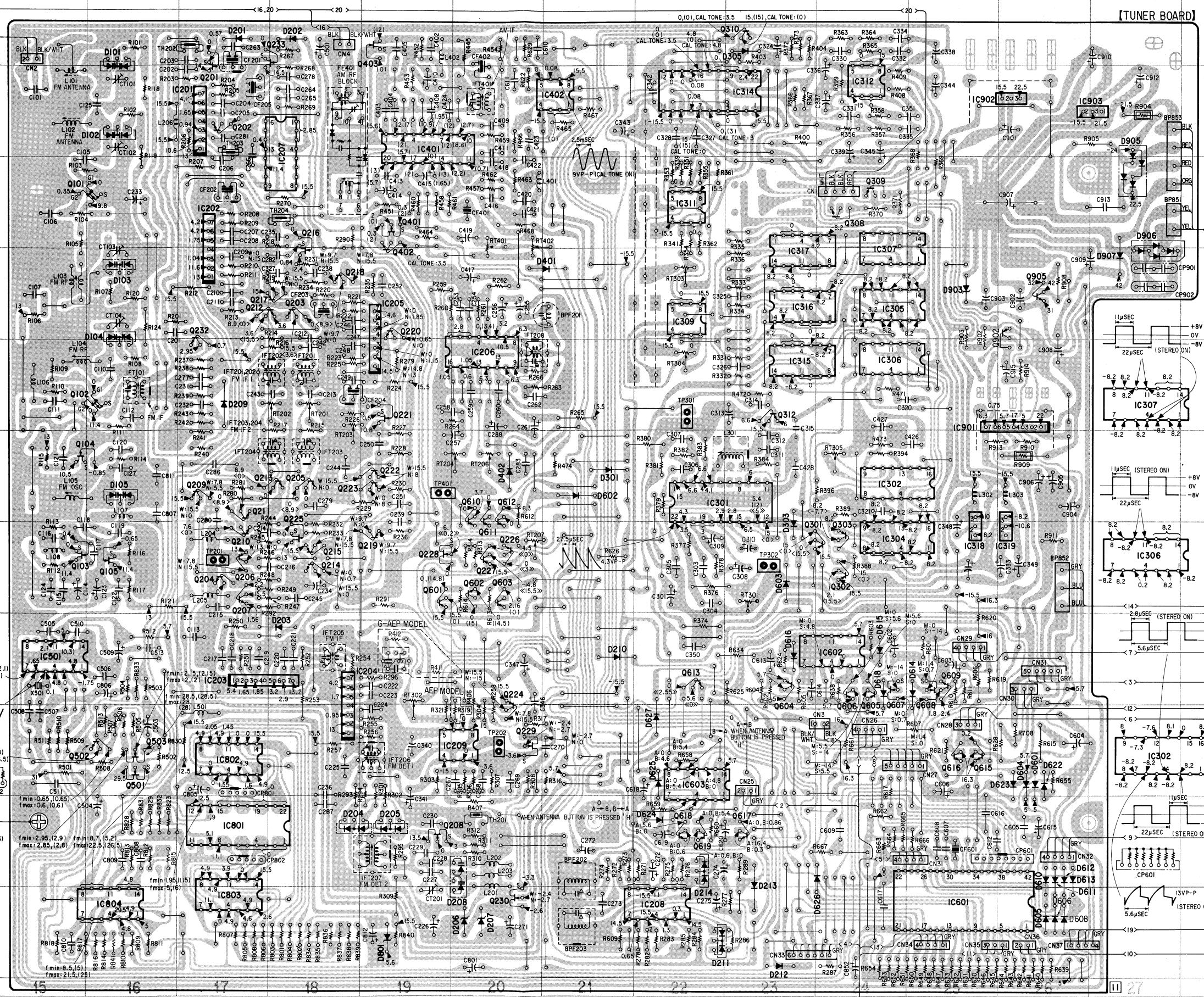
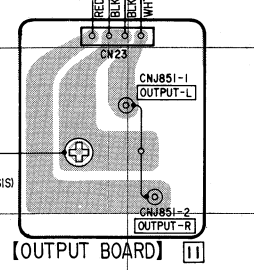
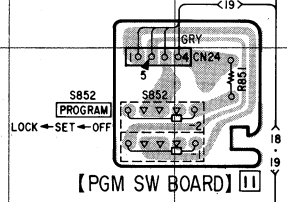
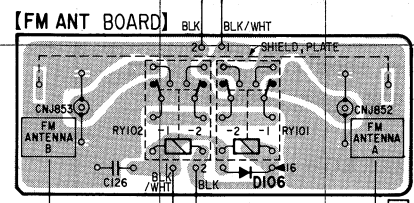

4-2. SCHEMATIC DIAGRAM. (1) See page 27 for notes

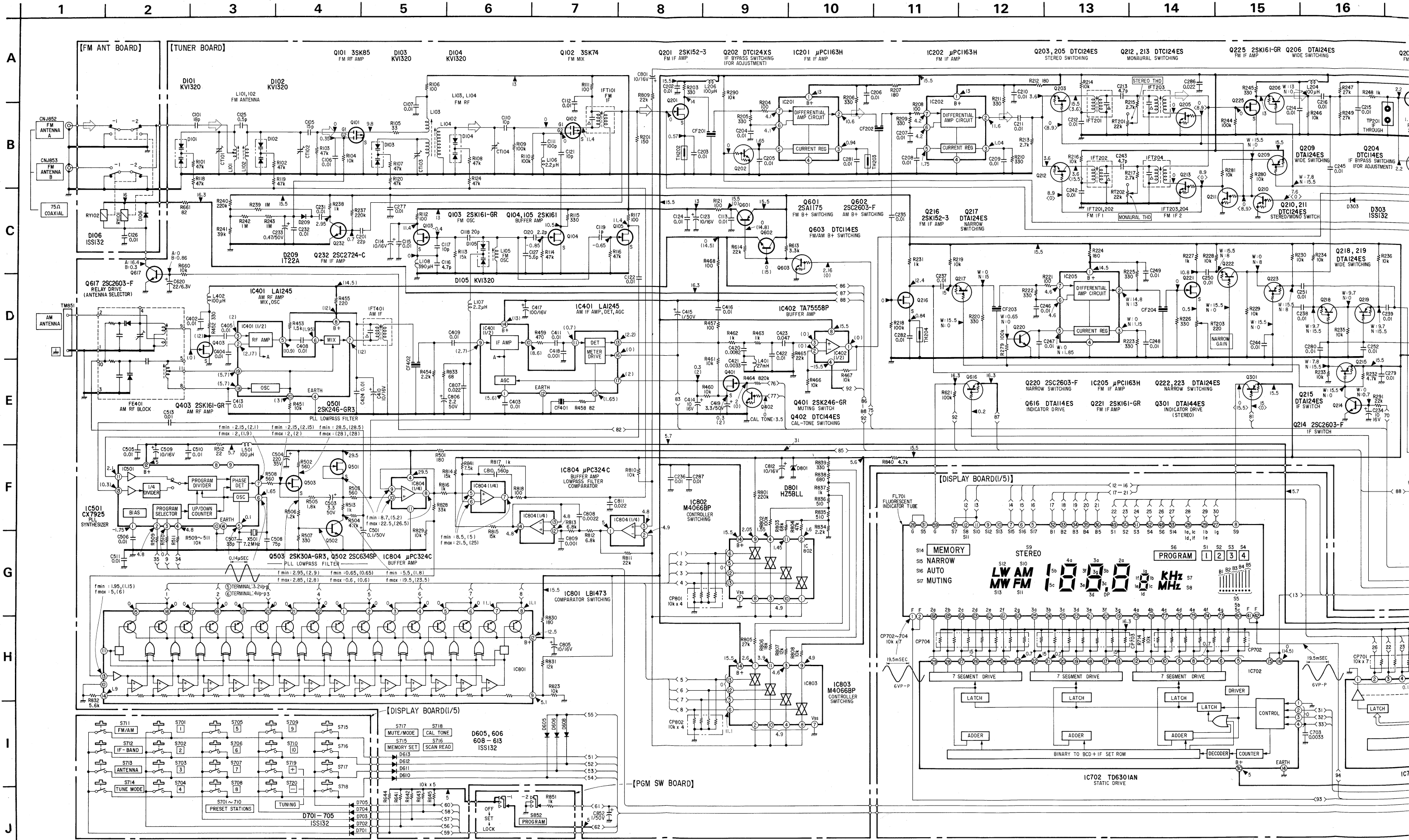

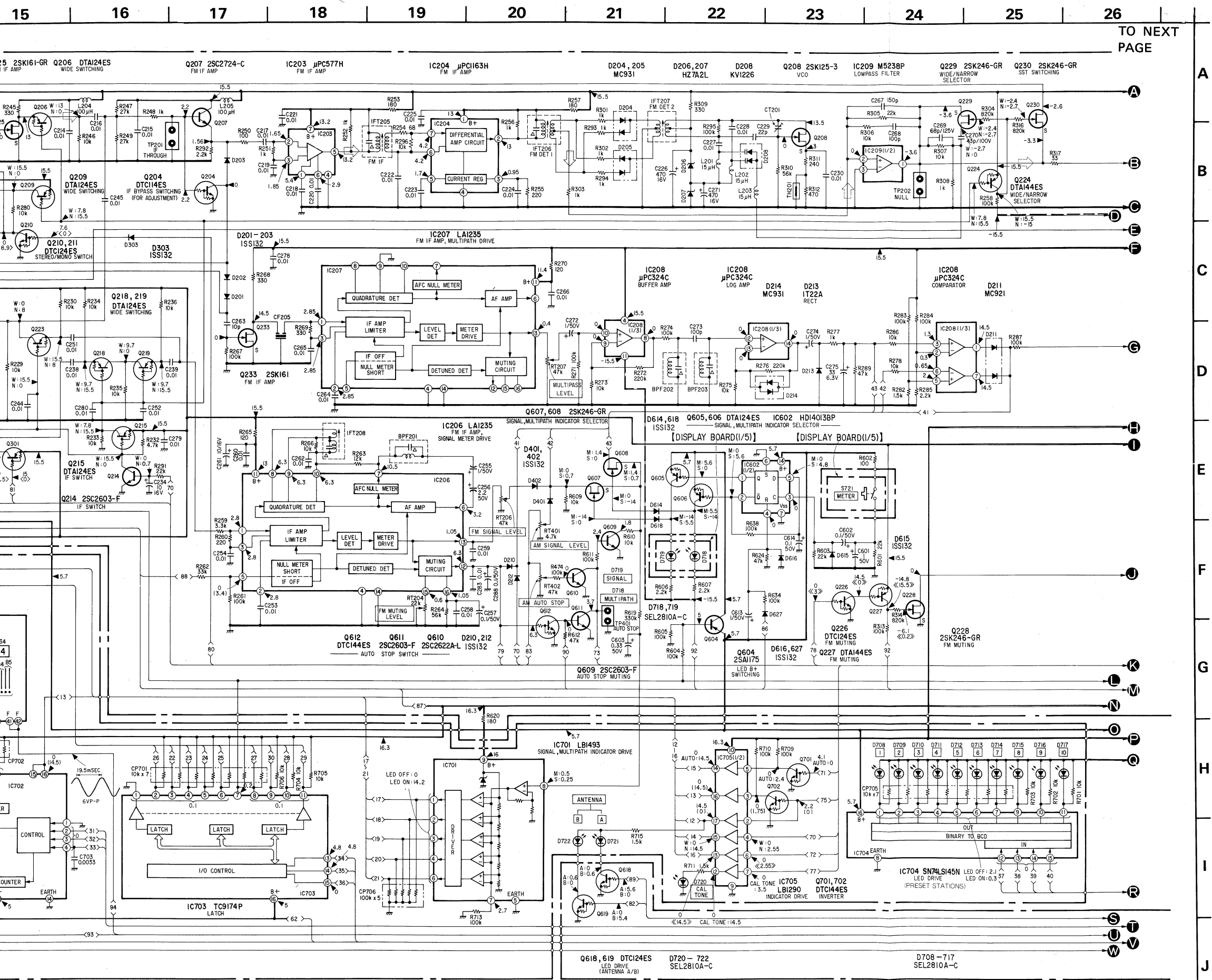

TO NEXT PAGE

4-3. SCHEMATIC DIAGRAM. (2)

1 2 3 4 5 6 7 8 9 10 11 12 13 14 15
FROM PAGE 24

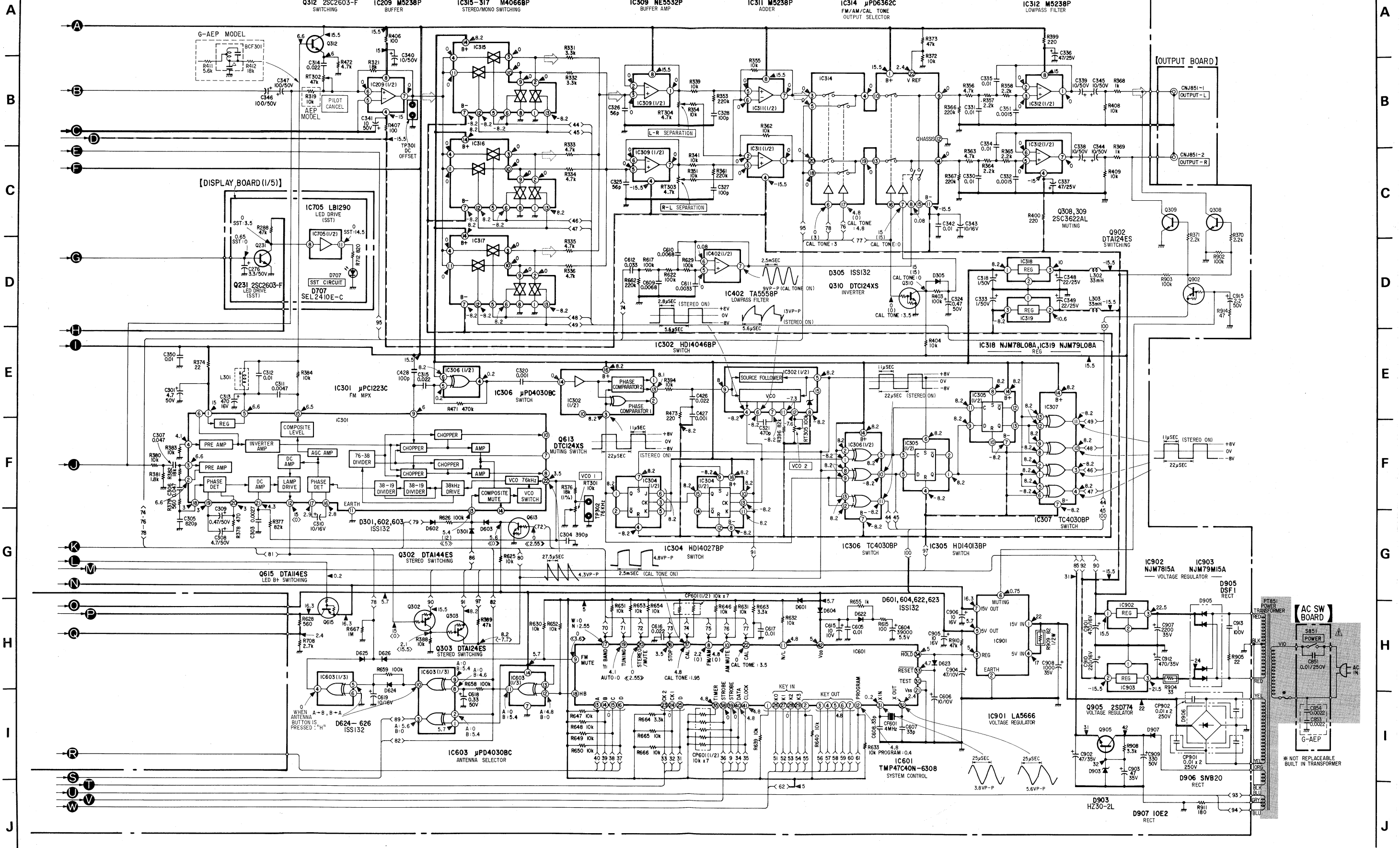

- Note:**
- All capaci 50 WV or and tantal
 - All resisc specified.
 - : sign
- Note: Th**
- Δ : in
 - : n
 - %: indicat
 - Switch
- Ref. N**
- S701
 - S702
 - S703
 - S704
 - S705
 - S706
 - S707
 - S708
 - S709
 - S710
 - S711
 - S712
 - S713
 - S714
 - S715
 - S716
 - S717
 - S718
 - S719
 - S720
 - S721
 - S851
 - S852
- : B
 - : B
 - : ad
 - Voltages noted.
 - Readings with a VO
 - No mark: FI
 - () : AI
 - < > : ST
 - ≪ ≫ : M
 - A : AI
 - B : AI
 - W : W
 - N : N
 - M : M
 - S : SI
- Waveforms using oscill
 - Voltage vari tion tolerar

SECTION 5
EXPLODED VIEWS

Note:

- All capacitors are in μF unless otherwise noted. pF: μF 50 WV or less are not indicated except for electrolytics and tantalums.
- All resistors are in Ω and $\frac{1}{4}\text{W}$ or less unless otherwise specified.
- \Rightarrow : signal path.

Note: The components identified by shading and mark \triangle are critical for safety. Replace only with part number specified.

- \triangle : internal component.
- \square : nonflammable resistor.
- %: indicates tolerances.
- Switch

Ref. No.	Switch	Position
S701	PRESET STATIONS 1	OFF
S702	" 2	"
S703	" 3	"
S704	" 4	"
S705	" 5	"
S706	" 6	"
S707	" 7	"
S708	" 8	"
S709	" 9	"
S710	" 10	"
S711	FM/AM	"
S712	IF-BAND	"
S713	ANTENNA	"
S714	TUNE MODE	"
S715	MEMORY SET	"
S716	SCAN READ	"
S717	MUTE/MODE	"
S718	CAL TONE	"
S719	TUNING +	"
S720	" -	"
S721	METER	"
S851	POWER	"
S852	PROGRAM	"

- --- : B+ bus.
- --- : B- bus.
- \square : adjustment for repair.
- Voltages are dc with respect to ground unless otherwise noted.
- Readings are taken under no-signal (detuned) conditions with a VOM (50 k Ω /V).
- No mark: FM
- () : AM
- < > : STEREO
- ◀ ▶ : MUTING
- A : ANTENNA A
- B : ANTENNA B
- W : WIDE
- N : NARROW
- M : MULTIPATH
- S : SIGNAL
- Waveforms are taken to ground in no-signal mode by using oscilloscope.
- Voltage variations may be noted due to normal production tolerances.

NOTE:

- The mechanical parts with no reference number in the exploded views are not supplied.
- Items marked " * " are not stocked since they are seldom required for routine service. Some delay should be anticipated when ordering these items.

- The construction parts of an assembled part are indicated with a collation number in the remark column.

The components identified by shading and mark \triangle are critical for safety. Replace only with part number specified.

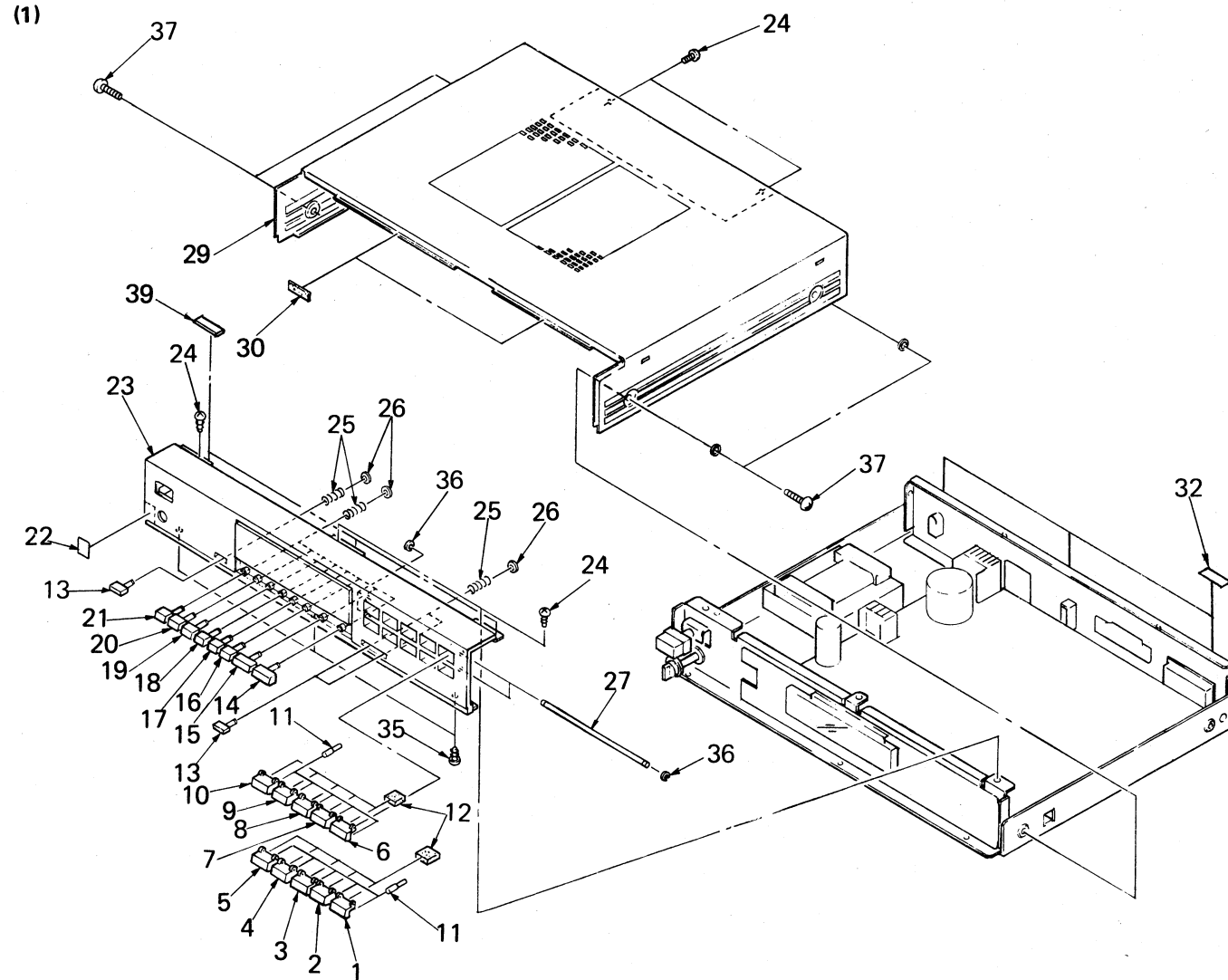

No.	Part No.	Description	Remarks	No.	Part No.	Description	Remarks
1	4-908-035-91	BUTTON, PRESET		18	4-915-406-71	BUTTON (A), SQUARE	
2	4-908-035-81	BUTTON, PRESET		19	4-915-406-61	BUTTON (A), SQUARE	
3	4-908-035-71	BUTTON, PRESET		20	4-915-406-51	BUTTON (A), SQUARE	
4	4-908-035-61	BUTTON, PRESET		21	4-915-406-41	BUTTON (A), SQUARE	
5	4-908-035-51	BUTTON, PRESET		22	3-703-713-41	STICKER, SONY SYMBOL (10)	
6	4-908-035-41	BUTTON, PRESET		23	X-4886-020-1	PANEL ASSY, FRONT	
7	4-908-035-31	BUTTON, PRESET		24	3-703-108-21	SCREW +BV 3X6, S TIGHT	
8	4-908-035-21	BUTTON, PRESET		25	4-915-427-01	SPRING, COMPRESSION	
9	4-908-035-11	BUTTON, PRESET		26	4-862-338-00	RING, STOPPER	
10	4-908-035-01	BUTTON, PRESET		27	*4-908-029-01	SHAFT, JOINT	
11	*4-908-028-01	JOINT, KNOB		29	4-908-043-21	CASE	
12	*4-908-050-01	CUSHION		30	3-831-441-XX	CUSHION, SPEAKER	
13	4-908-027-01	BUTTON (C), SQUARE		32	2-242-510-00	PAD, (C)	
14	4-908-022-81	BUTTON (D), SQUARE		35	7-685-751-09	SCREW +BVTT 3X6 (S)	
15	4-908-022-71	BUTTON (D), SQUARE		36	7-624-105-04	STOP RING 2.3, TYPE -E	
16	4-915-406-91	BUTTON (A), SQUARE		37	4-889-321-11	SCREW	
17	4-915-406-81	BUTTON (A), SQUARE		38	9-911-863-XX	INSULATOR	
				39	9-911-840-XX	SPACER	

SECTION 5
EXPLODED VIEWS

Note:

- All capacitors are in μF unless otherwise noted. pF: $\mu\mu\text{F}$ 50 WV or less are not indicated except for electrolytics and tantalums.
- All resistors are in Ω and $\frac{1}{4}\text{W}$ or less unless otherwise specified.
- \Rightarrow : signal path.

Note: The components identified by shading and mark Δ are critical for safety. Replace only with part number specified.

- Δ : internal component.
- \square : nonflammable resistor.
- %: indicates tolerances.
- Switch

Ref. No.	Switch	Position
S701	PRESET STATIONS 1	OFF
S702	" 2	"
S703	" 3	"
S704	" 4	"
S705	" 5	"
S706	" 6	"
S707	" 7	"
S708	" 8	"
S709	" 9	"
S710	" 10	"
S711	FM/AM	"
S712	IF-BAND	"
S713	ANTENNA	"
S714	TUNE MODE	"
S715	MEMORY SET	"
S716	SCAN READ	"
S717	MUTE/MODE	"
S718	CAL TONE	"
S719	TUNING +	"
S720	" -	"
S721	METER	"
S851	POWER	"
S852	PROGRAM	"

- --- : B+ bus.
- --- : B- bus.
- \square : adjustment for repair.
- Voltages are dc with respect to ground unless otherwise noted.
- Readings are taken under no-signal (detuned) conditions with a VOM (50 k Ω /V).
- No mark: FM
- () : AM
- < > : STEREO
- $\ll \gg$: MUTING
- A : ANTENNA A
- B : ANTENNA B
- W : WIDE
- N : NARROW
- M : MULTIPATH
- S : SIGNAL

- Waveforms are taken to ground in no-signal mode by using oscilloscope.
- Voltage variations may be noted due to normal production tolerances.

NOTE:

The mechanical parts with no reference number in the exploded views are not supplied.

Items marked " * " are not stocked since they are seldom required for routine service. Some delay should be anticipated when ordering these items.

The construction parts of an assembled part are indicated with a collation number in the remark column.

The components identified by shading and mark Δ are critical for safety. Replace only with part number specified.

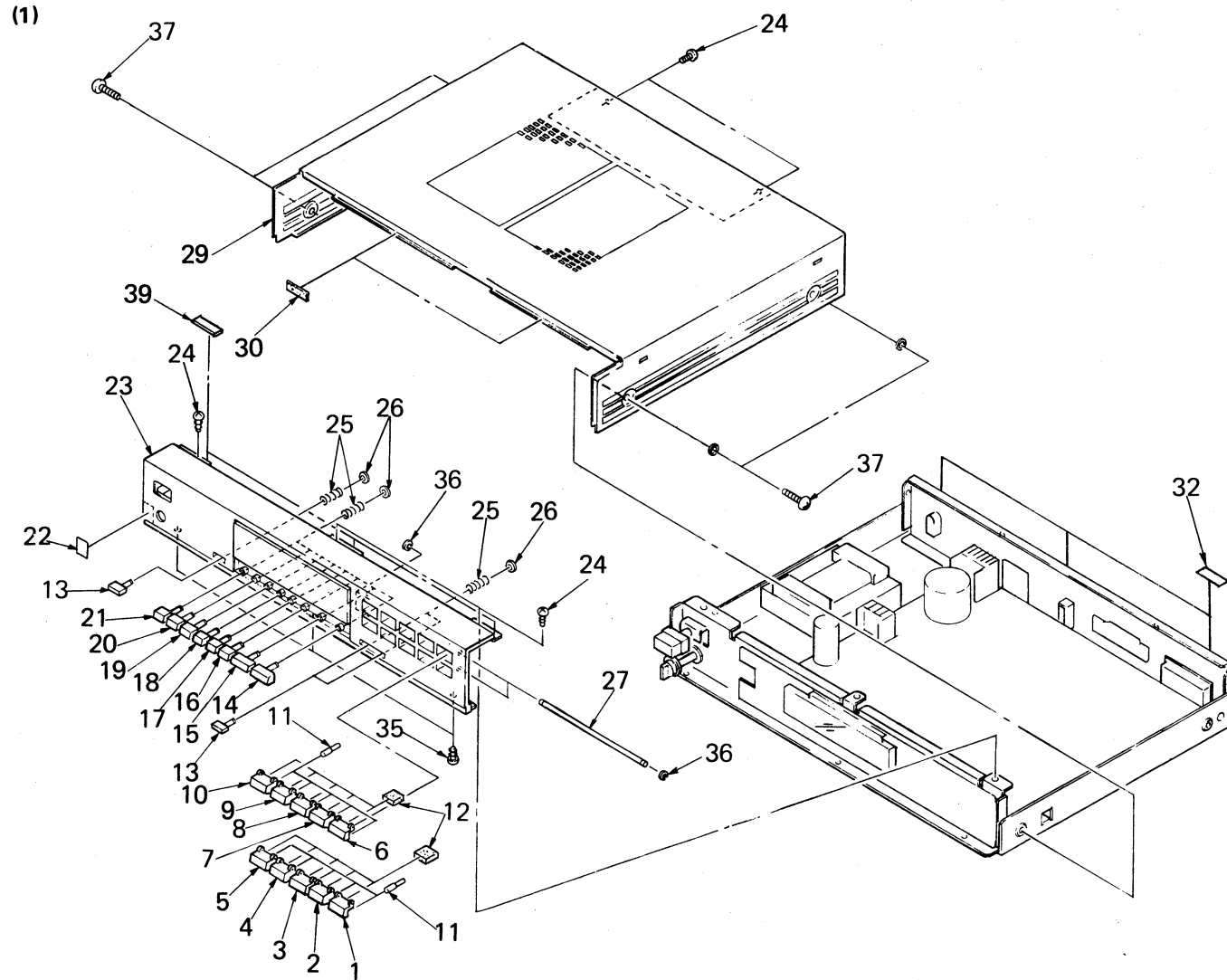

No.	Part No.	Description	Remarks	No.	Part No.	Description	Remarks
1	4-908-035-91	BUTTON, PRESET		18	4-915-406-71	BUTTON (A), SQUARE	
2	4-908-035-81	BUTTON, PRESET		19	4-915-406-61	BUTTON (A), SQUARE	
3	4-908-035-71	BUTTON, PRESET		20	4-915-406-51	BUTTON (A), SQUARE	
4	4-908-035-61	BUTTON, PRESET		21	4-915-406-41	BUTTON (A), SQUARE	
5	4-908-035-51	BUTTON, PRESET		22	3-703-713-41	STICKER, SONY SYMBOL (10)	
6	4-908-035-41	BUTTON, PRESET		23	X-4886-020-1	PANEL ASSY, FRONT	
7	4-908-035-31	BUTTON, PRESET		24	3-703-108-21	SCREW +BV 3X6, S TIGHT	
8	4-908-035-21	BUTTON, PRESET		25	4-915-427-01	SPRING, COMPRESSION	
9	4-908-035-11	BUTTON, PRESET		26	4-862-338-00	RING, STOPPER	
10	4-908-035-01	BUTTON, PRESET		27	*4-908-029-01	SHAFT, JOINT	
11	*4-908-028-01	JOINT, KNOB		29	4-908-043-21	CASE	
12	*4-908-050-01	CUSHION		30	3-831-441-XX	CUSHION, SPEAKER	
13	4-908-027-01	BUTTON (C), SQUARE		32	2-242-510-00	PAD, (C)	
14	4-908-022-81	BUTTON (D), SQUARE		35	7-685-751-09	SCREW +BVTT 3X6 (S)	
15	4-908-022-71	BUTTON (D), SQUARE		36	7-624-105-04	STOP RING 2.3, TYPE -E	
16	4-915-406-91	BUTTON (A), SQUARE		37	4-889-321-11	SCREW	
17	4-915-406-81	BUTTON (A), SQUARE		38	9-911-863-XX	INSULATOR	
				39	9-911-840-XX	SPACER	

(2)

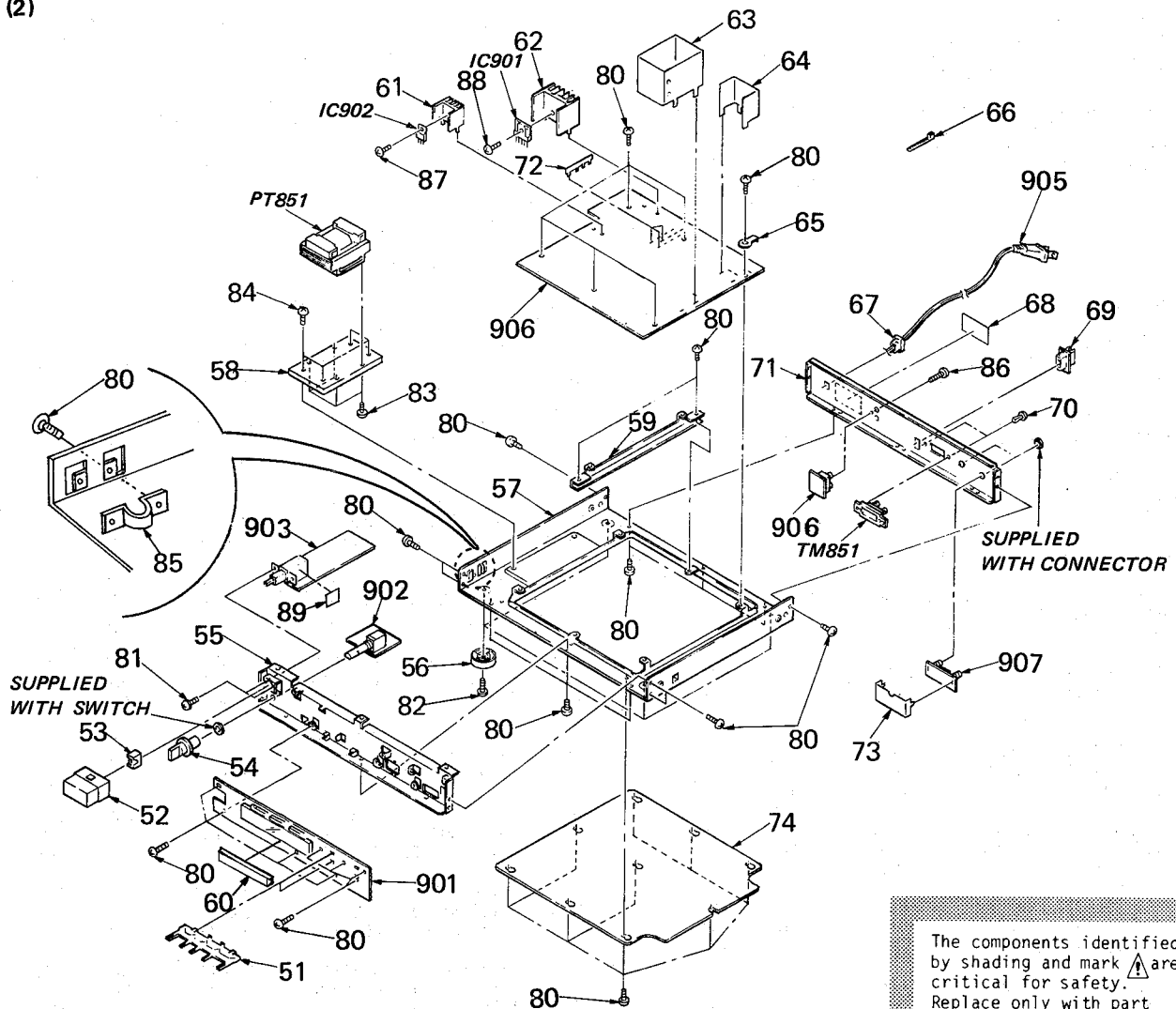

No.	Part No.	Description
51	*4-908-030-01	HOLDER, LED
52	4-908-046-01	KNOB, SQUARE
53	4-864-307-00	RING
54	4-908-045-01	KNOB, ROUND
55	*4-908-040-01	CHASSIS, FRONT
56	X-4886-009-1	LEG ASSY
57	*4-908-042-01	CHASSIS, MAIN
58	*4-908-063-01	BRACKET (C), TRANSFORMER
59	*4-908-032-01	CHASSIS (M)
60	*4-908-075-01	CUSHION
61	*4-363-146-31	HEAT SINK, V.OUT
62	*4-363-147-00	HEAT SINK, H.PIN
63	*4-911-326-01	PLATE (B), SHIELD
64	*4-911-325-01	PLATE (A), SHIELD
65	4-870-539-00	PLATE, GROUND
66	3-701-748-00	CLAMP
67	3-703-244-00	BUSHING (2104), CORD
68	*4-908-057-02	(AEP).....LABEL, MODEL NUMBER
	*4-908-057-12	(AEP).....LABEL, MODEL NUMBER
	*4-908-058-01	(G-AEP)...LABEL, MODEL NUMBER
69	*4-908-019-01	HOLDER (A), ANTENNA
70	4-812-134-00	RIVET NYLON, 3.5
71	*4-908-064-01	PLATE, JACK
72	*1-560-242-21	BUS BAR 4P

No.	Part No.	Description	Remarks
73	*4-908-070-01	PLATE, SHIELD	
74	*4-908-036-01	PLATE, BOTTOM	
80	7-685-751-09	SCREW +BVTT 3X6 (S)	
81	7-682-647-01	SCREW +PS 3X6	
82	7-685-883-09	SCREW +BVTT 4X12 (S)	
83	7-685-160-11	SCREW +P 4X10 TYPE2 NON-SLIT	
84	7-685-873-01	SCREW +BVTT 3X10 (S)	
85	4-908-020-01	PROTECTOR	
86	7-685-551-19	(AEP).....SCREW +BTP 3X20 TYPE2 N-S	
	7-703-473-01	(G-AEP)...SCREW, TERMINAL	
87	7-685-872-09	SCREW +BVTT 3X8 (S)	
88	7-685-646-79	SCREW +BVTP 3X8 TYPE2 IT-3	
89	3-664-468-00	CLOTH (B), INTERCEPTION	
901	*A-4474-496-A	MOUNTED PCB, DISPLAY	
902	*1-619-266-11	PC BOARD, PGM SW	
903	*1-619-265-11	PC BOARD, AC SW	
904	*A-4351-549-A	MOUNTED PCB, TUNER	
	*A-4351-550-A	(G-AEP)...MOUNTED PCB, TUNER	
905	⚠ 1-555-795-00	CORD, POWER	
906	*1-619-267-11	PC BOARD, OUTPUT	
907	*1-620-085-11	PC BOARD, FM ANT	
PT851	⚠ 1-448-580-12	TRANSFORMER, POWER	
TM851	1-537-026-11	TERMINAL BOARD (ANT)	

SECTION 6 ELECTRICAL PARTS LIST

NOTE:

- Items marked " * " are not stocked since they are seldom required for routine service. Some delay should be anticipated when ordering these items.
- If there are two or more same circuits in a set such as a stereophonic machine, only typical circuit parts may be indicated and capacitors and resistors in other same circuits may be omitted.

CAPACITORS:

MF: μ F, PF: μ PF.

RESISTORS

- All resistors are in ohms.
- F : nonflammable

COILS

MMH : mH, UH : μ H

SEMICONDUCTORS

In each case, U : μ , for example:
 UA...: μ A..., UPA...: μ PA..., UPC...: μ PC,
 UPD...: μ PD...

The components identified by shading and mark Δ are critical for safety. Replace only with part number specified.

ELECTRICAL PARTS

Ref.No.	Part No.	Description
901	*A-4474-496-A	MOUNTED PCB, DISPLAY
902	*1-619-266-11	PC BOARD, PGM SW
903	*1-619-265-11	PC BOARD, AC SW
904	*A-4351-549-A *A-4351-550-A	MOUNTED PCB, TUNER (G-AEP)...MOUNTED PCB, TUNER
905	Δ 1-555-795-00	CORD. POWER
906	*1-619-267-11	PC BOARD, OUTPUT
907	*1-620-085-11	PC BOARD, FM ANT
BCF301	1-235-892-11	(G-AEP)...FILTER
BPF201	1-235-046-00	ENCAPSULATED COMPONENT (B.E.F)
BPF202	1-421-877-11	COIL (FILTER)
BPF203	1-421-877-11	COIL (FILTER)
C101	1-162-205-31	CERAMIC 18PF 5% 50V
C105	1-162-203-31	CERAMIC 15PF 5% 50V
C106	1-162-306-31	CERAMIC 0.01MF 20% 16V
C107	1-162-306-31	CERAMIC 0.01MF 20% 16V
C110	1-162-199-31	CERAMIC 10PF 5% 50V
C111	1-162-282-31	CERAMIC 100PF 10% 50V
C112	1-162-306-31	CERAMIC 0.01MF 20% 16V
C113	1-162-306-31	CERAMIC 0.01MF 20% 16V
C114	1-123-617-00	ELECT 10MF 20% 16V
C115	1-162-306-31	CERAMIC 0.01MF 20% 16V
C116	1-162-195-31	CERAMIC 4.7PF 10% 50V
C117	1-162-199-31	CERAMIC 10PF 5% 50V
C118	1-162-206-31	CERAMIC 20PF 5% 50V
C119	1-162-187-31	CERAMIC 1PF 20% 50V
C120	1-162-191-31	CERAMIC 2.2PF 10% 50V
C121	1-162-199-31	CERAMIC 10PF 5% 50V
C122	1-162-306-31	CERAMIC 0.01MF 20% 16V
C123	1-123-617-00	ELECT 10MF 20% 16V
C124	1-162-306-31	CERAMIC 0.01MF 20% 16V
C125	1-102-934-00	CERAMIC 1PF 0.25PF 50V
C126	1-162-306-31	CERAMIC 0.01MF 20% 16V
C127	1-162-196-31	CERAMIC 5.6PF 10% 50V
C201	1-162-207-31	CERAMIC 22PF 5% 50V
C202	1-162-306-31	CERAMIC 0.01MF 20% 16V
C203	1-162-306-31	CERAMIC 0.01MF 20% 16V
C204	1-162-306-31	CERAMIC 0.01MF 20% 16V
C205	1-162-306-31	CERAMIC 0.01MF 20% 16V
C206	1-162-306-31	CERAMIC 0.01MF 20% 16V
C207	1-162-306-31	CERAMIC 0.01MF 20% 16V
C208	1-162-306-31	CERAMIC 0.01MF 20% 16V
C209	1-162-306-31	CERAMIC 0.01MF 20% 16V
C210	1-162-306-31	CERAMIC 0.01MF 20% 16V
C211	1-162-306-31	CERAMIC 0.01MF 20% 16V

ELECTRICAL PARTS

Ref.No.	Part No.	Description
C212	1-162-306-31	CERAMIC 0.01MF 20% 16V
C213	1-162-195-31	CERAMIC 4.7PF 10% 50V
C214	1-162-306-31	CERAMIC 0.01MF 20% 16V
C215	1-162-306-31	CERAMIC 0.01MF 20% 16V
C216	1-162-306-31	CERAMIC 0.01MF 20% 16V
C217	1-162-306-31	CERAMIC 0.01MF 20% 16V
C218	1-162-306-31	CERAMIC 0.01MF 20% 16V
C219	1-162-306-31	CERAMIC 0.01MF 20% 16V
C220	1-162-306-31	CERAMIC 0.01MF 20% 16V
C221	1-162-306-31	CERAMIC 0.01MF 20% 16V
C222	1-162-306-31	CERAMIC 0.01MF 20% 16V
C223	1-162-306-31	CERAMIC 0.01MF 20% 16V
C224	1-162-306-31	CERAMIC 0.01MF 20% 16V
C225	1-162-306-31	CERAMIC 0.01MF 20% 16V
C226	1-123-323-00	ELECT 470MF 20% 16V
C227	1-162-306-31	CERAMIC 0.01MF 20% 16V
C228	1-162-306-31	CERAMIC 0.01MF 20% 16V
C229	1-102-514-00	CERAMIC 22PF 5% 50V
C230	1-162-306-31	CERAMIC 0.01MF 20% 16V
C231	1-162-306-31	CERAMIC 0.01MF 20% 16V
C232	1-162-306-31	CERAMIC 0.01MF 20% 16V
C233	1-123-610-00	ELECT 0.47MF 20% 50V
C234	1-123-617-00	ELECT 10MF 20% 16V
C235	1-162-306-31	CERAMIC 0.01MF 20% 16V
C236	1-162-306-31	CERAMIC 0.01MF 20% 16V
C237	1-162-306-31	CERAMIC 0.01MF 20% 16V
C238	1-162-306-31	CERAMIC 0.01MF 20% 16V
C239	1-162-306-31	CERAMIC 0.01MF 20% 16V
C242	1-162-306-31	CERAMIC 0.01MF 20% 16V
C243	1-162-195-31	CERAMIC 4.7PF 10% 50V
C244	1-162-306-31	CERAMIC 0.01MF 20% 16V
C245	1-162-306-31	CERAMIC 0.01MF 20% 16V
C246	1-162-306-31	CERAMIC 0.01MF 20% 16V
C247	1-162-306-31	CERAMIC 0.01MF 20% 16V
C248	1-162-306-31	CERAMIC 0.01MF 20% 16V
C249	1-162-306-31	CERAMIC 0.01MF 20% 16V
C250	1-162-306-31	CERAMIC 0.01MF 20% 16V
C251	1-162-306-31	CERAMIC 0.01MF 20% 16V
C252	1-162-306-31	CERAMIC 0.01MF 20% 16V
C253	1-162-306-31	CERAMIC 0.01MF 20% 16V
C254	1-162-306-31	CERAMIC 0.01MF 20% 16V
C255	1-123-611-00	ELECT 1MF 20% 50V
C256	1-123-612-00	ELECT 2.2MF 20% 50V
C257	1-123-607-00	ELECT 0.1MF 20% 50V
C258	1-162-306-31	CERAMIC 0.01MF 20% 16V

ELECTRICAL PARTS

Ref.No.	Part No.	Description				
C259	1-162-306-31	CERAMIC	0.01MF	20%	16V	
C260	1-162-306-31	CERAMIC	0.01MF	20%	16V	
C261	1-123-617-00	ELECT	10MF	20%	16V	
C262	1-162-306-31	CERAMIC	0.01MF	20%	16V	
C263	1-162-199-31	CERAMIC	10PF	5%	50V	
C264	1-162-306-31	CERAMIC	0.01MF	20%	16V	
C265	1-162-306-31	CERAMIC	0.01MF	20%	16V	
C266	1-162-306-31	CERAMIC	0.01MF	20%	16V	
C267	1-162-284-31	CERAMIC	150PF	10%	50V	
C268	1-162-282-31	CERAMIC	100PF	10%	50V	
C269	1-104-265-00	POLYSTYRENE	68PF	10%	125V	
C270	1-107-291-00	MICA	43PF	5%	100V	
C271	1-123-323-00	ELECT	470MF	20%	16V	
C272	1-123-611-00	ELECT	1MF	20%	50V	
C273	1-162-282-31	CERAMIC	100PF	10%	50V	
C274	1-123-611-00	ELECT	1MF	20%	50V	
C275	1-123-646-00	ELECT	33MF	20%	6.3V	
C276	1-123-613-00	ELECT	3.3MF	20%	50V	
C277	1-162-306-31	CERAMIC	0.01MF	20%	16V	
C278	1-162-306-31	CERAMIC	0.01MF	20%	16V	
C279	1-162-306-31	CERAMIC	0.01MF	20%	16V	
C280	1-162-306-31	CERAMIC	0.01MF	20%	16V	
C281	1-162-306-31	CERAMIC	0.01MF	20%	16V	
C282	1-162-306-31	CERAMIC	0.01MF	20%	16V	
C283	1-162-306-31	CERAMIC	0.01MF	20%	16V	
C286	1-161-494-00	CERAMIC	0.022MF	30%	25V	
C287	1-162-306-31	CERAMIC	0.01MF	20%	16V	
C288	1-123-607-00	ELECT	0.1MF	20%	50V	
C301	1-123-369-00	ELECT	4.7MF	20%	50V	
C303	1-110-200-00	MYLAR	0.0027MF	5%	50V	
C304	1-104-067-00	POLYSTYRENE	390PF	5%	50V	
C305	1-130-470-00	MYLAR	820PF	5%	50V	
C306	1-136-161-00	FILM	0.047MF	5%	50V	
C307	1-136-161-00	FILM	0.047MF	5%	50V	
C308	1-123-619-00	ELECT	4.7MF	20%	50V	
C309	1-123-610-00	ELECT	0.47MF	20%	50V	
C310	1-123-617-00	ELECT	10MF	20%	16V	
C311	1-110-203-00	MYLAR	0.0047MF	5%	50V	
C312	1-110-207-00	MYLAR	0.01MF	5%	50V	
C313	1-123-323-00	ELECT	470MF	20%	16V	
C314	1-110-211-00	MYLAR	0.022MF	5%	50V	
C315	1-110-211-00	MYLAR	0.022MF	5%	50V	
C318	1-123-380-00	ELECT	1MF	20%	50V	
C320	1-110-195-00	MYLAR	0.001MF	5%	50V	
C321	1-130-467-00	MYLAR	470PF	5%	50V	
C324	1-123-610-00	ELECT	0.47MF	20%	50V	
C326	1-162-217-31	CERAMIC	56PF	5%	50V	
C328	1-103-701-00	POLYSTYRENE	100PF	5%	50V	
C331	1-110-207-00	MYLAR	0.01MF	5%	50V	
C333	1-123-380-00	ELECT	1MF	20%	50V	
C335	1-110-207-00	MYLAR	0.01MF	5%	50V	
C336	1-123-332-00	ELECT	47MF	20%	25V	
C339	1-123-356-00	ELECT	10MF	20%	50V	
C340	1-123-356-00	ELECT	10MF	20%	50V	
C341	1-123-356-00	ELECT	10MF	20%	50V	
C342	1-162-306-31	CERAMIC	0.01MF	20%	16V	
C343	1-123-617-00	ELECT	10MF	20%	16V	

ELECTRICAL PARTS

Ref.No.	Part No.	Description				
C345	1-123-356-00	ELECT	10MF	20%	50V	
C346	1-123-360-00	ELECT	100MF	20%	50V	
C347	1-123-360-00	ELECT	100MF	20%	50V	
C348	1-123-330-00	ELECT	22MF	20%	25V	
C349	1-123-330-00	ELECT	22MF	20%	25V	
C350	1-162-306-31	CERAMIC	0.01MF	20%	16V	
C402	1-162-306-31	CERAMIC	0.01MF	20%	16V	
C403	1-162-306-31	CERAMIC	0.01MF	20%	16V	
C404	1-162-306-31	CERAMIC	0.01MF	20%	16V	
C405	1-162-306-31	CERAMIC	0.01MF	20%	16V	
C408	1-162-306-31	CERAMIC	0.01MF	20%	16V	
C409	1-162-306-31	CERAMIC	0.01MF	20%	16V	
C410	1-123-617-00	ELECT	10MF	20%	16V	
C411	1-162-306-31	CERAMIC	0.01MF	20%	16V	
C413	1-162-306-31	CERAMIC	0.01MF	20%	16V	
C414	1-123-617-00	ELECT	10MF	20%	16V	
C415	1-123-611-00	ELECT	1MF	20%	50V	
C416	1-162-306-31	CERAMIC	0.01MF	20%	16V	
C417	1-123-333-00	ELECT	100MF	20%	16V	
C418	1-162-294-31	CERAMIC	0.001MF	10%	50V	
C419	1-123-613-00	ELECT	3.3MF	20%	50V	
C420	1-110-206-00	MYLAR	0.0082MF	5%	50V	
C421	1-110-201-00	MYLAR	0.0033MF	5%	50V	
C422	1-110-207-00	MYLAR	0.01MF	5%	50V	
C423	1-136-161-00	FILM	0.047MF	5%	50V	
C424	1-162-306-31	CERAMIC	0.01MF	20%	16V	
C426	1-110-211-00	MYLAR	0.022MF	5%	50V	
C427	1-110-195-00	MYLAR	0.001MF	5%	50V	
C428	1-107-300-00	MICA	100PF	5%	100V	
C501	1-123-607-00	ELECT	0.1MF	20%	50V	
C503	1-123-613-00	ELECT	3.3MF	20%	50V	
C504	1-123-346-00	ELECT	220MF	20%	35V	
C505	1-162-306-31	CERAMIC	0.01MF	20%	16V	
C506	1-162-306-31	CERAMIC	0.01MF	20%	16V	
C507	1-102-518-00	CERAMIC	33PF	5%	50V	
C508	1-102-526-00	CERAMIC	75PF	5%	50V	
C509	1-123-617-00	ELECT	10MF	20%	16V	
C510	1-162-306-31	CERAMIC	0.01MF	20%	16V	
C511	1-162-306-31	CERAMIC	0.01MF	20%	16V	
C513	1-162-306-31	CERAMIC	0.01MF	20%	16V	
C601	1-123-611-00	ELECT	1MF	20%	50V	
C602	1-123-607-00	ELECT	0.1MF	20%	50V	
C603	1-123-609-00	ELECT	0.33MF	20%	50V	
C604	1-124-958-11	ELECT	39000MF		5.5V	
C605	1-162-306-31	CERAMIC	0.01MF	20%	16V	
C606	1-131-377-00	TANTALUM	10MF	10%	10V	
C607	1-162-211-31	CERAMIC	33PF	5%	50V	
C608	1-162-211-31	CERAMIC	33PF	5%	50V	
C609	1-110-205-00	MYLAR	0.0068MF	5%	50V	
C610	1-110-205-00	MYLAR	0.0068MF	5%	50V	
C611	1-110-201-00	MYLAR	0.0033MF	5%	50V	
C612	1-130-489-00	MYLAR	0.033MF	5%	50V	
C613	1-123-611-00	ELECT	1MF	20%	50V	
C614	1-123-607-00	ELECT	0.1MF	20%	50V	
C615	1-131-377-00	TANTALUM	10MF	10%	10V	
C616	1-161-494-00	CERAMIC	0.022MF	30%	25V	
C617	1-162-306-31	CERAMIC	0.01MF	20%	16V	

ST-S800ES

ELECTRICAL PARTS

Ref.No.	Part No.	Description			
C618	1-123-609-00	ELECT	0.33MF	20%	50V
C619	1-123-617-00	ELECT	10MF	20%	16V
C620	1-123-618-00	ELECT	22MF	20%	6.3V
C703	1-162-303-31	CERAMIC	0.0033MF	30%	16V
C801	1-123-617-00	ELECT	10MF	20%	16V
C805	1-123-617-00	ELECT	10MF	20%	16V
C806	1-123-612-00	ELECT	2.2MF	20%	50V
C807	1-101-005-00	CERAMIC	0.022MF		50V
C808	1-110-199-00	MYLAR	0.0022MF	5%	50V
C809	1-110-195-00	MYLAR	0.001MF	5%	50V
C810	1-130-468-00	MYLAR	560PF	5%	50V
C811	1-101-005-00	CERAMIC	0.022MF		50V
C812	1-123-617-00	ELECT	10MF	20%	16V
C851	1-161-744-00	CERAMIC	0.01MF		400V
C852	1-123-611-00	ELECT	1MF	20%	50V
C853	1-161-742-12	(G-AEP)...CERAMIC	2200PF		
C854	1-161-742-12	(G-AEP)...CERAMIC	2200PF		
C901	1-123-323-00	ELECT	470MF	20%	16V
C902	1-123-359-00	ELECT	47MF	20%	35V
C903	1-123-359-00	ELECT	47MF	20%	35V
C904	1-123-306-00	ELECT	47MF	20%	10V
C905	1-123-617-00	ELECT	10MF	20%	16V
C906	1-123-617-00	ELECT	10MF	20%	16V
C907	1-125-438-11	ELECT(BLOCK)	2200MF	20%	35V
C908	1-123-349-00	ELECT	1000MF	20%	35V
C909	1-123-362-00	ELECT	330MF	20%	50V
C910	1-123-321-00	ELECT	220MF	20%	16V
C912	1-123-348-00	ELECT	470MF	20%	35V
C913	1-130-789-00	FILM	1MF	5%	100V
C915	1-123-612-00	ELECT	2.2MF	20%	50V
CF201	1-567-393-11	FILTER, CERAMIC			
CF202	1-567-393-11	FILTER, CERAMIC			
CF203	1-527-968-11	FILTER, CERAMIC			
CF204	1-527-968-11	FILTER, CERAMIC			
CF205	1-527-968-11	FILTER, CERAMIC			
CF401	1-527-981-00	FILTER, CERAMIC			
CF402	1-527-826-00	FILTER, CERAMIC			
CF601	1-567-192-11	OSCILLATOR, CERAMIC			
CNJ1	*1-564-507-21	PLUG, CONNECTOR 4P			
CNJ2	*1-564-505-21	PLUG, CONNECTOR 2P			
CNJ3	*1-564-505-21	PLUG, CONNECTOR 2P			
CNJ4	*1-564-505-21	PLUG, CONNECTOR 2P			
CNJ851	1-507-912-21	JACK, PIN 2P			
CNJ852	1-564-235-00	PLUG, CONNECTOR (PAL)			
CNJ853	1-564-235-00	PLUG, CONNECTOR (PAL)			
CP601	1-233-021-11	COMPOSITION CIRCUIT BLOCK			
CP701	1-233-022-11	COMPOSITION CIRCUIT BLOCK			
CP702	1-233-021-11	COMPOSITION CIRCUIT BLOCK			
CP703	1-233-021-11	COMPOSITION CIRCUIT BLOCK			
CP704	1-233-021-11	COMPOSITION CIRCUIT BLOCK			
CP705	1-233-021-11	COMPOSITION CIRCUIT BLOCK			
CP706	1-233-020-11	COMPOSITION CIRCUIT BLOCK			
CP801	1-232-986-11	COMPOSITION CIRCUIT BLOCK			
CP802	1-232-986-11	COMPOSITION CIRCUIT BLOCK			
CP901	1-102-394-00	CERAMIC	0.01MF		250V
CP902	1-102-394-00	CERAMIC	0.01MF		250V

ELECTRICAL PARTS

Ref.No.	Part No.	Description
CT101	1-141-304-11	TRIMMER, CERAMIC
CT102	1-141-304-11	TRIMMER, CERAMIC
CT103	1-141-304-11	TRIMMER, CERAMIC
CT104	1-141-304-11	TRIMMER, CERAMIC
CT201	1-141-264-00	CAP, TRIMMER
D101	8-719-901-59	DIODE KV1320
D102	8-719-901-59	DIODE KV1320
D103	8-719-901-59	DIODE KV1320
D104	8-719-901-59	DIODE KV1320
D105	8-719-901-59	DIODE KV1320
D106	8-719-940-76	DIODE 1SS132
D201	8-719-940-76	DIODE 1SS132
D202	8-719-940-76	DIODE 1SS132
D203	8-719-940-76	DIODE 1SS132
D204	8-719-000-12	DIODE MC931
D205	8-719-000-12	DIODE MC931
D206	8-719-910-72	DIODE HZ7A2L
D207	8-719-910-72	DIODE HZ7A2L
D208	8-719-912-27	DIODE KV1226
D209	8-719-022-21	DIODE 1T22A
D210	8-719-940-76	DIODE 1SS132
D211	8-719-000-06	DIODE MC921
D212	8-719-940-76	DIODE 1SS132
D213	8-719-022-21	DIODE 1T22A
D214	8-719-000-12	DIODE MC931
D301	8-719-940-76	DIODE 1SS132
D303	8-719-940-76	DIODE 1SS132
D305	8-719-940-76	DIODE 1SS132
D401	8-719-940-76	DIODE 1SS132
D402	8-719-940-76	DIODE 1SS132
D601	8-719-940-76	DIODE 1SS132
D602	8-719-940-76	DIODE 1SS132
D603	8-719-940-76	DIODE 1SS132
D604	8-719-940-76	DIODE 1SS132
D605	8-719-940-76	DIODE 1SS132
D606	8-719-940-76	DIODE 1SS132
D609	8-719-940-76	DIODE 1SS132
D610	8-719-940-76	DIODE 1SS132
D611	8-719-940-76	DIODE 1SS132
D612	8-719-940-76	DIODE 1SS132
D613	8-719-940-76	DIODE 1SS132
D614	8-719-940-76	DIODE 1SS132
D615	8-719-940-76	DIODE 1SS132
D616	8-719-940-76	DIODE 1SS132
D618	8-719-940-76	DIODE 1SS132
D622	8-719-940-76	DIODE 1SS132
D623	8-719-940-76	DIODE 1SS132
D624	8-719-940-76	DIODE 1SS132
D625	8-719-940-76	DIODE 1SS132
D626	8-719-940-76	DIODE 1SS132
D627	8-719-940-76	DIODE 1SS132
D701	8-719-940-76	DIODE 1SS132
D702	8-719-940-76	DIODE 1SS132
D703	8-719-940-76	DIODE 1SS132

The components identified by shading and mark  are critical for safety. Replace only with part number specified.

ELECTRICAL PARTS

Ref.No.	Part No.	Description
D704	8-719-940-76	DIODE 1SS132
D705	8-719-940-76	DIODE 1SS132
D707	8-719-301-43	DIODE SEL2410E-C
D708	8-719-301-52	DIODE SEL2810A-C
D709	8-719-301-52	DIODE SEL2810A-C
D710	8-719-301-52	DIODE SEL2810A-C
D711	8-719-301-52	DIODE SEL2810A-C
D712	8-719-301-52	DIODE SEL2810A-C
D713	8-719-301-52	DIODE SEL2810A-C
D714	8-719-301-52	DIODE SEL2810A-C
D715	8-719-301-52	DIODE SEL2810A-C
D716	8-719-301-52	DIODE SEL2810A-C
D717	8-719-301-52	DIODE SEL2810A-C
D718	8-719-301-52	DIODE SEL2810A-C
D719	8-719-301-52	DIODE SEL2810A-C
D720	8-719-301-52	DIODE SEL2810A-C
D721	8-719-301-52	DIODE SEL2810A-C
D722	8-719-301-52	DIODE SEL2810A-C
D801	8-719-951-12	DIODE HZ5BLL
D903	8-719-913-02	DIODE HZ30-2L
D905	8-719-200-70	DIODE DSF1
D906	8-719-511-20	DIODE S1VB20
D907	8-719-200-77	DIODE IOE2N
FE401	1-235-812-11	ENCAPSULATED COMPONENT
FL701	1-519-385-11	INDICATOR TUBE, FLUORESCENT
IC201	8-759-111-63	IC UPC1163H
IC202	8-759-111-63	IC UPC1163H
IC203	8-759-157-70	IC UPC577H
IC204	8-759-111-63	IC UPC1163H
IC205	8-759-111-63	IC UPC1163H
IC206	8-759-812-35	IC LA1235
IC207	8-759-812-35	IC LA1235
IC208	8-759-132-40	IC UPC324C
IC209	8-759-602-83	IC M5238P
IC301	8-759-100-14	IC UPC1223C
IC302	8-759-040-46	IC HD14046BP
IC304	8-759-340-27	IC HD14027BP
IC305	8-759-340-13	IC HD14013BP
IC306	8-759-240-30	IC TC4030BP
IC307	8-759-240-30	IC TC4030BP
IC309	8-759-900-72	IC NE5532P
IC311	8-759-602-83	IC M5238P
IC312	8-759-602-83	IC M5238P
IC314	8-759-107-79	IC UPD6362C
IC315	8-759-601-43	IC M4066BP
IC316	8-759-601-43	IC M4066BP
IC317	8-759-601-43	IC M4066BP
IC318	8-759-708-08	IC NJM78L08A
IC319	8-759-700-67	IC NJM79L08A
IC401	8-759-812-45	IC LA1245
IC402	8-807-285-11	IC TA75558P
IC501	8-759-925-00	IC CX-7925
IC601	8-759-202-03	IC TMP47C40N-6308
IC602	8-759-340-13	IC HD14013BP
IC603	8-759-240-30	IC TC4030BP

ELECTRICAL PARTS

Ref.No.	Part No.	Description
IC701	8-759-800-95	IC LB1493
IC702	8-759-206-71	IC TD6301AN
IC703	8-759-202-07	IC TC9174P
IC704	8-759-901-45	IC SN74LS145N
IC705	8-759-812-90	IC LA1290
IC801	8-759-802-78	IC LB1473
IC802	8-759-601-43	IC M4066BP
IC803	8-759-601-43	IC M4066BP
IC804	8-759-132-40	IC UPC432C
IC901	8-759-802-61	IC LA5666
IC902	8-759-700-55	IC NJM7815A
IC903	8-759-179-15	IC UPC7915H
IFT101	1-404-666-11	COIL, FM IFT
IFT201	1-404-664-11	COIL, FM IFT (1)
IFT202	1-404-664-11	COIL, FM IFT (1)
IFT203	1-404-665-11	COIL, FM IFT (2)
IFT204	1-404-665-11	COIL, FM IFT (2)
IFT205	1-404-666-11	COIL, FM IFT
IFT206	1-404-668-11	COIL, FM DET (1)
IFT207	1-404-595-11	COIL, FM DET (2)
IFT208	1-404-669-11	COIL, DISCRIMINATOR
IFT401	1-404-326-00	TRANSFORMER, IF
L101	1-459-617-11	COIL
L102	1-459-647-11	COIL (WITH CORE)
L103	1-426-249-11	COIL (RF)
L104	1-459-647-11	COIL (WITH CORE)
L105	1-459-618-11	COIL
L106	1-408-555-00	MICRO INDUCTOR 2.2UH
L107	1-408-555-00	MICRO INDUCTOR 2.2UH
L108	1-407-176-XX	MICRO INDUCTOR 390UH
L201	1-408-565-00	MICRO INDUCTOR 15UH
L202	1-408-565-00	MICRO INDUCTOR 15UH
L203	1-408-565-00	MICRO INDUCTOR 15UH
L204	1-408-575-00	MICRO INDUCTOR 100UH
L205	1-408-575-00	MICRO INDUCTOR 100UH
L206	1-408-575-00	MICRO INDUCTOR 100UH
L301	1-409-413-11	COIL (TUNING)
L302	1-408-930-00	MICRO INDUCTOR 33MMH
L303	1-408-930-00	MICRO INDUCTOR 33MMH
L401	1-408-929-00	MICRO INDUCTOR 27MMH
L402	1-408-575-00	MICRO INDUCTOR 100UH
L501	1-408-575-00	MICRO INDUCTOR 100UH
PT851A	1-448-580-12	TRANSFORMER, POWER
Q101	8-729-318-51	TRANSISTOR 3SK85
Q102	8-729-100-00	TRANSISTOR 3SK74
Q103	8-729-216-13	TRANSISTOR 2SK161-GR
Q104	8-729-216-13	TRANSISTOR 2SK161-GR
Q105	8-729-216-13	TRANSISTOR 2SK161-GR
Q201	8-729-800-43	TRANSISTOR 2SK152-3
Q202	8-729-900-83	TRANSISTOR DTC124XS
Q203	8-729-900-36	TRANSISTOR DTC124ES
Q204	8-729-900-80	TRANSISTOR DTC114ES
Q205	8-729-900-36	TRANSISTOR DTC124ES
Q206	8-729-900-63	TRANSISTOR DTA124ES
Q207	8-729-672-42	TRANSISTOR 2SC2724-C
Q208	8-729-802-43	TRANSISTOR 2SK125-3
Q209	8-729-900-63	TRANSISTOR DTA124ES
Q210	8-729-900-36	TRANSISTOR DTC124ES

The components identified by shading and mark  are critical for safety. Replace only with part number specified.

ST-S800ES

ELECTRICAL PARTS

Ref.No.	Part No.	Description
Q211	8-729-900-36	TRANSISTOR DTC124ES
Q212	8-729-900-36	TRANSISTOR DTC124ES
Q213	8-729-900-36	TRANSISTOR DTC124ES
Q214	8-729-606-33	TRANSISTOR 2SC2603-F
Q215	8-729-900-36	TRANSISTOR DTC124ES
Q216	8-729-800-43	TRANSISTOR 2SK152-3
Q217	8-729-900-63	TRANSISTOR DTA124ES
Q218	8-729-900-63	TRANSISTOR DTA124ES
Q219	8-729-900-63	TRANSISTOR DTA124ES
Q220	8-729-606-33	TRANSISTOR 2SC2603F
Q221	8-729-216-13	TRANSISTOR 2SK161-GR
Q222	8-729-900-63	TRANSISTOR DTA124ES
Q223	8-729-900-63	TRANSISTOR DTA124ES
Q224	8-729-900-65	TRANSISTOR DTA144ES
Q225	8-729-216-13	TRANSISTOR 2SK161-GR
Q226	8-729-900-36	TRANSISTOR DTC124ES
Q227	8-729-900-65	TRANSISTOR DTA144ES
Q228	8-729-224-62	TRANSISTOR 2SK246-GR
Q229	8-729-224-62	TRANSISTOR 2SK246-GR
Q230	8-729-224-62	TRANSISTOR 2SK246-GR
Q231	8-729-606-33	TRANSISTOR 2SC2603-F
Q232	8-729-672-42	TRANSISTOR 2SC2724-C
Q233	8-729-216-13	TRANSISTOR 2SK161-GR
Q301	8-729-900-65	TRANSISTOR DTA144ES
Q302	8-729-900-65	TRANSISTOR DTA144ES
Q303	8-729-900-63	TRANSISTOR DTA124ES
Q308	8-729-107-98	TRANSISTOR 2SC3622A-L
Q309	8-729-107-98	TRANSISTOR 2SC3622A-L
Q310	8-729-900-83	TRANSISTOR DTC124XS
Q312	8-729-606-33	TRANSISTOR 2SC2603-F
Q401	8-729-224-62	TRANSISTOR 2SK246-GR
Q402	8-729-900-89	TRANSISTOR DTC144ES
Q403	8-729-216-13	TRANSISTOR 2SK161-GR
Q501	8-729-202-67	TRANSISTOR 2SK246-GR3
Q502	8-729-600-27	TRANSISTOR 2SC634SP
Q503	8-729-203-05	TRANSISTOR 2SK30A-GR3
Q601	8-729-117-54	TRANSISTOR 2SA1175
Q602	8-729-606-33	TRANSISTOR 2SC2603-F
Q603	8-729-900-80	TRANSISTOR DTC114ES
Q604	8-729-117-54	TRANSISTOR 2SA1175
Q605	8-729-900-63	TRANSISTOR DTA124ES
Q606	8-729-900-63	TRANSISTOR DTA124ES
Q607	8-729-224-62	TRANSISTOR 2SK246-GR
Q608	8-729-224-62	TRANSISTOR 2SK246-GR
Q609	8-729-606-33	TRANSISTOR 2SC2603-F
Q610	8-729-107-98	TRANSISTOR 2SC3622A-L
Q611	8-729-606-33	TRANSISTOR 2SC2603-F
Q612	8-729-900-89	TRANSISTOR DTC144ES
Q613	8-729-900-83	TRANSISTOR DTC124XS
Q615	8-729-900-61	TRANSISTOR DTA114ES
Q616	8-729-900-61	TRANSISTOR DTA114ES
Q617	8-729-606-33	TRANSISTOR 2SC2603-F
Q618	8-729-900-36	TRANSISTOR DTC124ES
Q619	8-729-900-36	TRANSISTOR DTC124ES
Q701	8-729-900-89	TRANSISTOR DTC144ES
Q702	8-729-900-89	TRANSISTOR DTC144ES
Q902	8-729-900-63	TRANSISTOR DTA124ES
Q905	8-729-177-43	TRANSISTOR 2SD774

ELECTRICAL PARTS

Ref.No.	Part No.	Description			
R101	1-249-437-11	CARBON	47K	5%	1/6W
R102	1-249-437-11	CARBON	47K	5%	1/6W
R103	1-249-437-11	CARBON	47K	5%	1/6W
R104	1-249-429-11	CARBON	10K	5%	1/6W
R105	1-247-795-00	CARBON	33	5%	1/6W
R106	1-249-405-11	CARBON	100	5%	1/6W
R107	1-249-437-11	CARBON	47K	5%	1/6W
R108	1-249-437-11	CARBON	47K	5%	1/6W
R109	1-249-441-11	CARBON	100K	5%	1/6W
R110	1-249-441-11	CARBON	100K	5%	1/6W
R111	1-249-405-11	CARBON	100	5%	1/6W
R112	1-249-405-11	CARBON	100	5%	1/6W
R113	1-247-859-00	CARBON	15K	5%	1/6W
R114	1-249-437-11	CARBON	47K	5%	1/6W
R115	1-247-819-00	CARBON	330	5%	1/6W
R116	1-249-437-11	CARBON	47K	5%	1/6W
R117	1-249-405-11	CARBON	100	5%	1/6W
R118	1-249-437-11	CARBON	47K	5%	1/6W
R119	1-249-437-11	CARBON	47K	5%	1/6W
R120	1-249-437-11	CARBON	47K	5%	1/6W
R121	1-247-700-11	CARBON	100	5%	1/4W F
R124	1-249-437-11	CARBON	47K	5%	1/6W
R201	1-247-811-00	CARBON	150	5%	1/6W
R203	1-247-819-00	CARBON	330	5%	1/6W
R204	1-249-405-11	CARBON	100	5%	1/6W
R205	1-247-819-00	CARBON	330	5%	1/6W
R206	1-247-819-00	CARBON	330	5%	1/6W
R207	1-247-703-11	CARBON	180	5%	1/4W F
R208	1-249-405-11	CARBON	100	5%	1/6W
R209	1-247-819-00	CARBON	330	5%	1/6W
R210	1-247-819-00	CARBON	330	5%	1/6W
R211	1-247-819-00	CARBON	330	5%	1/6W
R212	1-247-703-11	CARBON	180	5%	1/4W F
R213	1-249-422-11	CARBON	2.7K	5%	1/6W
R214	1-249-429-11	CARBON	10K	5%	1/6W
R215	1-249-422-11	CARBON	2.7K	5%	1/6W
R216	1-249-429-11	CARBON	10K	5%	1/6W
R217	1-249-422-11	CARBON	2.7K	5%	1/6W
R218	1-249-441-11	CARBON	100K	5%	1/6W
R219	1-249-429-11	CARBON	10K	5%	1/6W
R220	1-247-819-00	CARBON	330	5%	1/6W
R221	1-249-405-11	CARBON	100	5%	1/6W
R222	1-247-819-00	CARBON	330	5%	1/6W
R224	1-247-703-11	CARBON	180	5%	1/4W F
R225	1-247-819-00	CARBON	330	5%	1/6W
R226	1-247-819-00	CARBON	330	5%	1/6W
R227	1-249-417-11	CARBON	1K	5%	1/6W
R228	1-249-429-11	CARBON	10K	5%	1/6W
R229	1-249-429-11	CARBON	10K	5%	1/6W
R230	1-249-429-11	CARBON	10K	5%	1/6W
R231	1-249-417-11	CARBON	1K	5%	1/6W
R232	1-249-425-11	CARBON	4.7K	5%	1/6W
R233	1-249-429-11	CARBON	10K	5%	1/6W
R234	1-249-429-11	CARBON	10K	5%	1/6W
R235	1-249-429-11	CARBON	10K	5%	1/6W
R236	1-249-429-11	CARBON	10K	5%	1/6W
R237	1-247-887-00	CARBON	220K	5%	1/6W

ELECTRICAL PARTS

Ref.No.	Part No.	Description				
R238	1-249-417-11	CARBON	1K	5%	1/6W	
R239	1-247-903-00	CARBON	1M	5%	1/6W	
R240	1-247-887-00	CARBON	220K	5%	1/6W	
R241	1-247-869-00	CARBON	39K	5%	1/6W	
R242	1-247-903-00	CARBON	1M	5%	1/6W	
R243	1-247-903-00	CARBON	1M	5%	1/6W	
R244	1-249-441-11	CARBON	100K	5%	1/6W	
R245	1-247-819-00	CARBON	330	5%	1/6W	
R246	1-249-429-11	CARBON	10K	5%	1/6W	
R247	1-249-434-11	CARBON	27K	5%	1/6W	
R248	1-249-417-11	CARBON	1K	5%	1/6W	
R249	1-249-434-11	CARBON	27K	5%	1/6W	
R250	1-249-405-11	CARBON	100	5%	1/6W	
R251	1-249-417-11	CARBON	1K	5%	1/6W	
R252	1-249-417-11	CARBON	1K	5%	1/6W	
R253	1-247-703-11	CARBON	180	5%	1/4W	F
R254	1-247-803-00	CARBON	68	5%	1/6W	
R255	1-247-815-00	CARBON	220	5%	1/6W	
R256	1-249-417-11	CARBON	1K	5%	1/6W	
R257	1-247-703-11	CARBON	180	5%	1/4W	F
R258	1-249-441-11	CARBON	100K	5%	1/6W	
R259	1-249-423-11	CARBON	3.3K	5%	1/6W	
R260	1-247-815-00	CARBON	220	5%	1/6W	
R261	1-249-441-11	CARBON	100K	5%	1/6W	
R262	1-249-435-11	CARBON	33K	5%	1/6W	
R263	1-247-857-00	CARBON	12K	5%	1/6W	
R264	1-247-873-00	CARBON	56K	5%	1/6W	
R265	1-247-701-11	CARBON	120	5%	1/4W	F
R266	1-249-429-11	CARBON	10K	5%	1/6W	
R267	1-249-441-11	CARBON	100K	5%	1/6W	
R268	1-247-819-00	CARBON	330	5%	1/6W	
R269	1-247-819-00	CARBON	330	5%	1/6W	
R270	1-247-701-11	CARBON	120	5%	1/4W	F
R271	1-249-441-11	CARBON	100K	5%	1/6W	
R272	1-247-887-00	CARBON	220K	5%	1/6W	
R273	1-249-429-11	CARBON	10K	5%	1/6W	
R274	1-249-441-11	CARBON	100K	5%	1/6W	
R275	1-249-429-11	CARBON	10K	5%	1/6W	
R276	1-247-887-00	CARBON	220K	5%	1/6W	
R277	1-249-417-11	CARBON	1K	5%	1/6W	
R278	1-249-429-11	CARBON	10K	5%	1/6W	
R279	1-249-441-11	CARBON	100K	5%	1/6W	
R280	1-249-429-11	CARBON	10K	5%	1/6W	
R281	1-249-429-11	CARBON	10K	5%	1/6W	
R282	1-249-419-11	CARBON	1.5K	5%	1/6W	
R283	1-249-441-11	CARBON	100K	5%	1/6W	
R284	1-249-441-11	CARBON	100K	5%	1/6W	
R285	1-247-839-00	CARBON	2.2K	5%	1/6W	
R286	1-249-429-11	CARBON	10K	5%	1/6W	
R287	1-249-441-11	CARBON	100K	5%	1/6W	
R288	1-249-437-11	CARBON	47K	5%	1/6W	
R289	1-249-437-11	CARBON	47K	5%	1/6W	
R290	1-249-429-11	CARBON	10K	5%	1/6W	
R291	1-249-433-11	CARBON	22K	5%	1/6W	
R292	1-247-839-00	CARBON	2.2K	5%	1/6W	
R293	1-249-417-11	CARBON	1K	5%	1/6W	
R294	1-249-417-11	CARBON	1K	5%	1/6W	

ELECTRICAL PARTS

Ref.No.	Part No.	Description				
R295	1-249-441-11	CARBON	100K	5%	1/6W	
R296	1-249-429-11	CARBON	10K	5%	1/6W	
R301	1-249-417-11	CARBON	1K	5%	1/6W	
R302	1-249-417-11	CARBON	1K	5%	1/6W	
R303	1-249-417-11	CARBON	1K	5%	1/6W	
R304	1-247-901-00	CARBON	820K	5%	1/6W	
R305	1-249-433-11	CARBON	22K	5%	1/6W	
R306	1-249-429-11	CARBON	10K	5%	1/6W	
R307	1-249-429-11	CARBON	10K	5%	1/6W	
R308	1-249-417-11	CARBON	1K	5%	1/6W	
R309	1-247-706-11	CARBON	330	5%	1/4W	F
R310	1-247-873-00	CARBON	56K	5%	1/6W	
R311	1-247-816-00	CARBON	240	5%	1/6W	
R312	1-247-823-00	CARBON	470	5%	1/6W	
R313	1-249-441-11	CARBON	100K	5%	1/6W	
R314	1-247-901-00	CARBON	820K	5%	1/6W	
R316	1-247-901-00	CARBON	820K	5%	1/6W	
R317	1-247-795-00	CARBON	33	5%	1/6W	
R319	1-249-429-11	(AEP)...CARBON	10K	5%	1/6W	
R321	1-247-865-00	(G-AEP)...CARBON	27K	5%	1/6W	
R321	1-249-432-11	(AEP).....CARBON	18K	5%	1/6W	
R331	1-249-423-11	(AEP).....CARBON	3.3K	5%	1/6W	
R333	1-249-425-11	CARBON	4.7K	5%	1/6W	
R335	1-249-425-11	CARBON	4.7K	5%	1/6W	
R339	1-249-429-11	CARBON	10K	5%	1/6W	
R353	1-247-887-00	CARBON	220K	5%	1/6W	
R354	1-249-429-11	CARBON	10K	5%	1/6W	
R355	1-249-429-11	CARBON	10K	5%	1/6W	
R356	1-249-425-11	CARBON	4.7K	5%	1/6W	
R357	1-247-839-00	CARBON	2.2K	5%	1/6W	
R358	1-247-839-00	CARBON	2.2K	5%	1/6W	
R366	1-247-887-00	CARBON	220K	5%	1/6W	
R368	1-249-417-11	CARBON	1K	5%	1/6W	
R370	1-247-839-00	CARBON	2.2K	5%	1/6W	
R371	1-247-839-00	CARBON	2.2K	5%	1/6W	
R372	1-249-429-11	CARBON	10K	5%	1/6W	
R373	1-249-437-11	CARBON	47K	5%	1/6W	
R374	1-247-692-11	CARBON	22	5%	1/4W	F
R376	1-214-759-00	METAL	18K	1%	1/4W	
R377	1-249-440-11	CARBON	82K	5%	1/6W	
R378	1-247-823-00	CARBON	470	5%	1/6W	
R379	1-249-414-11	CARBON	560	5%	1/6W	
R380	1-249-429-11	CARBON	10K	5%	1/6W	
R381	1-249-420-11	CARBON	1.8K	5%	1/6W	
R382	1-249-432-11	CARBON	18K	5%	1/6W	
R383	1-249-429-11	CARBON	10K	5%	1/6W	
R384	1-249-429-11	CARBON	10K	5%	1/6W	
R388	1-249-429-11	CARBON	10K	5%	1/6W	
R389	1-249-437-11	CARBON	47K	5%	1/6W	
R394	1-249-429-11	CARBON	10K	5%	1/6W	
R396	1-249-440-11	CARBON	82K	5%	1/6W	
R399	1-247-704-11	CARBON	220	5%	1/4W	F
R400	1-247-704-11	CARBON	220	5%	1/4W	F
R403	1-249-441-11	CARBON	100K	5%	1/6W	
R404	1-249-429-11	CARBON	10K	5%	1/6W	
R406	1-247-700-11	CARBON	100	5%	1/4W	F
R407	1-247-700-11	CARBON	100	5%	1/4W	F

ST-S800ES

ELECTRICAL PARTS

Ref.No.	Part No.	Description			
R408	1-249-429-11	CARBON	10K	5%	1/6W
R411	1-247-849-00	(G-AEP)...CARBON	5.6K	5%	1/6W
R412	1-247-861-00	(G-AEP)...CARBON	18K	5%	1/6W
R451	1-249-429-11	CARBON	10K	5%	1/6W
R452	1-247-819-00	CARBON	330	5%	1/6W
R453	1-249-419-11	CARBON	1.5K	5%	1/6W
R454	1-247-839-00	CARBON	2.2K	5%	1/6W
R455	1-247-704-11	CARBON	220	5%	1/4W F
R457	1-249-405-11	CARBON	100	5%	1/6W
R458	1-247-805-00	CARBON	82	5%	1/6W
R459	1-247-823-00	CARBON	470	5%	1/6W
R460	1-249-429-11	CARBON	10K	5%	1/6W
R461	1-249-429-11	CARBON	10K	5%	1/6W
R462	1-249-417-11	CARBON	1K	5%	1/6W
R463	1-249-417-11	CARBON	1K	5%	1/6W
R464	1-247-901-00	CARBON	820K	5%	1/6W
R465	1-249-433-11	CARBON	22K	5%	1/6W
R466	1-249-429-11	CARBON	10K	5%	1/6W
R467	1-249-429-11	CARBON	10K	5%	1/6W
R468	1-247-700-11	CARBON	100	5%	1/4W F
R471	1-247-895-00	CARBON	470K	5%	1/6W
R472	1-249-425-11	CARBON	4.7K	5%	1/6W
R473	1-247-815-00	CARBON	220	5%	1/6W
R474	1-249-441-11	CARBON	100K	5%	1/6W
R501	1-247-703-11	CARBON	180	5%	1/4W F
R502	1-249-414-11	CARBON	560	5%	1/6W
R503	1-249-414-11	CARBON	560	5%	1/6W
R504	1-249-425-11	CARBON	4.7K	5%	1/6W
R505	1-249-420-11	CARBON	1.8K	5%	1/6W
R506	1-247-833-00	CARBON	1.2K	5%	1/6W
R507	1-247-819-00	CARBON	330	5%	1/6W
R508	1-249-414-11	CARBON	560	5%	1/6W
R509	1-249-429-11	CARBON	10K	5%	1/6W
R510	1-249-429-11	CARBON	10K	5%	1/6W
R511	1-249-429-11	CARBON	10K	5%	1/6W
R512	1-247-692-11	CARBON	22	5%	1/4W F
R513	1-249-417-11	CARBON	1K	5%	1/6W
R601	1-249-433-11	CARBON	22K	5%	1/6W
R602	1-249-405-11	CARBON	100	5%	1/6W
R603	1-249-433-11	CARBON	22K	5%	1/6W
R604	1-249-441-11	CARBON	100K	5%	1/6W
R605	1-249-441-11	CARBON	100K	5%	1/6W
R606	1-247-717-11	CARBON	2.2K	5%	1/4W
R607	1-247-717-11	CARBON	2.2K	5%	1/4W
R609	1-249-429-11	CARBON	10K	5%	1/6W
R610	1-249-429-11	CARBON	10K	5%	1/6W
R611	1-249-441-11	CARBON	100K	5%	1/6W
R612	1-249-437-11	CARBON	47K	5%	1/6W
R613	1-249-423-11	CARBON	3.3K	5%	1/6W
R614	1-249-433-11	CARBON	22K	5%	1/6W
R615	1-247-700-11	CARBON	100	5%	1/4W
R617	1-249-441-11	CARBON	100K	5%	1/6W
R619	1-247-891-00	CARBON	330K	5%	1/6W
R620	1-247-703-11	CARBON	180	5%	1/4W F
R621	1-249-441-11	CARBON	100K	5%	1/6W
R622	1-249-441-11	CARBON	100K	5%	1/6W
R624	1-249-437-11	CARBON	47K	5%	1/6W

ELECTRICAL PARTS

Ref.No.	Part No.	Description			
R625	1-249-429-11	CARBON	10K	5%	1/6W
R626	1-249-441-11	CARBON	100K	5%	1/6W
R628	1-247-710-11	CARBON	560	5%	1/4W
R629	1-249-441-11	CARBON	100K	5%	1/6W
R630	1-249-429-11	CARBON	10K	5%	1/6W
R631	1-249-429-11	CARBON	10K	5%	1/6W
R632	1-249-429-11	CARBON	10K	5%	1/6W
R633	1-249-429-11	CARBON	10K	5%	1/6W
R634	1-249-441-11	CARBON	100K	5%	1/6W
R638	1-249-441-11	CARBON	100K	5%	1/6W
R639	1-249-429-11	CARBON	10K	5%	1/6W
R640	1-249-429-11	CARBON	10K	5%	1/6W
R641	1-249-429-11	CARBON	10K	5%	1/6W
R642	1-249-429-11	CARBON	10K	5%	1/6W
R643	1-249-429-11	CARBON	10K	5%	1/6W
R644	1-249-429-11	CARBON	10K	5%	1/6W
R645	1-249-429-11	CARBON	10K	5%	1/6W
R646	1-249-429-11	CARBON	10K	5%	1/6W
R647	1-249-429-11	CARBON	10K	5%	1/6W
R648	1-249-429-11	CARBON	10K	5%	1/6W
R649	1-249-429-11	CARBON	10K	5%	1/6W
R650	1-249-429-11	CARBON	10K	5%	1/6W
R651	1-249-429-11	CARBON	10K	5%	1/6W
R652	1-249-429-11	CARBON	10K	5%	1/6W
R653	1-249-429-11	CARBON	10K	5%	1/6W
R654	1-249-429-11	CARBON	10K	5%	1/6W
R655	1-249-417-11	CARBON	1K	5%	1/6W
R658	1-249-441-11	CARBON	100K	5%	1/6W
R659	1-249-441-11	CARBON	100K	5%	1/6W
R660	1-249-429-11	CARBON	10K	5%	1/6W
R661	1-247-699-11	CARBON	82	5%	1/4W F
R662	1-247-887-00	CARBON	220K	5%	1/6W
R663	1-249-423-11	CARBON	3.3K	5%	1/6W
R664	1-249-423-11	CARBON	3.3K	5%	1/6W
R665	1-249-429-11	CARBON	10K	5%	1/6W
R666	1-249-429-11	CARBON	10K	5%	1/6W
R667	1-247-903-00	CARBON	1M	5%	1/6W
R701	1-249-429-11	CARBON	10K	5%	1/6W
R702	1-249-429-11	CARBON	10K	5%	1/6W
R703	1-249-429-11	CARBON	10K	5%	1/6W
R704	1-249-429-11	CARBON	10K	5%	1/6W
R705	1-249-429-11	CARBON	10K	5%	1/6W
R706	1-249-429-11	CARBON	10K	5%	1/6W
R708	1-249-422-11	CARBON	2.7K	5%	1/6W
R709	1-249-441-11	CARBON	100K	5%	1/6W
R710	1-249-441-11	CARBON	100K	5%	1/6W
R711	1-247-135-00	CARBON	1.5K	5%	1/4W
R712	1-247-712-11	CARBON	820	5%	1/4W
R713	1-249-441-11	CARBON	100K	5%	1/6W
R714	1-249-429-11	CARBON	10K	5%	1/6W
R715	1-249-419-11	CARBON	1.5K	5%	1/6W
R801	1-247-887-00	CARBON	220K	5%	1/6W
R802	1-249-441-11	CARBON	100K	5%	1/6W
R803	1-247-875-00	CARBON	68K	5%	1/6W
R804	1-249-437-11	CARBON	47K	5%	1/6W
R805	1-249-434-11	CARBON	27K	5%	1/6W
R806	1-249-432-11	CARBON	18K	5%	1/6W

ELECTRICAL PARTS

Ref.No.	Part No.	Description			
R807	1-247-857-00	CARBON	12K	5%	1/6W
R808	1-249-429-11	CARBON	10K	5%	1/6W
R809	1-249-433-11	CARBON	22K	5%	1/6W
R810	1-249-429-11	CARBON	10K	5%	1/6W
R811	1-249-433-11	CARBON	22K	5%	1/6W
R812	1-247-851-00	CARBON	6.8K	5%	1/6W
R813	1-247-851-00	CARBON	6.8K	5%	1/6W
R814	1-247-859-00	CARBON	15K	5%	1/6W
R815	1-247-859-00	CARBON	15K	5%	1/6W
R816	1-249-417-11	CARBON	1K	5%	1/6W
R817	1-249-417-11	CARBON	1K	5%	1/6W
R818	1-249-405-11	CARBON	100	5%	1/6W
R823	1-249-429-11	CARBON	10K	5%	1/6W
R828	1-249-435-11	CARBON	33K	5%	1/6W
R829	1-249-429-11	CARBON	10K	5%	1/6W
R830	1-247-703-11	CARBON	180	5%	1/4W F
R831	1-247-853-00	CARBON	8.2K	5%	1/6W
R832	1-247-849-00	CARBON	5.6K	5%	1/6W
R833	1-247-803-00	CARBON	68	5%	1/6W
R834	1-247-839-00	CARBON	2.2K	5%	1/6W
R835	1-247-824-00	CARBON	510	5%	1/6W
R836	1-247-824-00	CARBON	510	5%	1/6W
R837	1-249-417-11	CARBON	1K	5%	1/6W
R838	1-249-415-11	CARBON	680	5%	1/6W
R839	1-247-819-00	CARBON	330	5%	1/6W
R840	1-249-425-11	CARBON	4.7K	5%	1/6W
R841	1-247-852-00	CARBON	7.5K	5%	1/6W
R851	1-249-417-11	CARBON	1K	5%	1/6W
R902	1-249-441-11	CARBON	100K	5%	1/6W
R903	1-249-441-11	CARBON	100K	5%	1/6W
R904	1-247-694-11	CARBON	33	5%	1/4W F
R905	1-247-692-11	CARBON	22	5%	1/4W F
R908	1-247-719-11	CARBON	3.3K	5%	1/4W F
R909	1-247-738-11	CARBON	82	5%	1/2W F
R910	1-249-437-11	CARBON	47K	5%	1/6W
R911	1-247-813-00	CARBON	180	5%	1/6W
R914	1-247-799-00	CARBON	47	5%	1/6W
RT201	1-230-631-11	RES, ADJ, CARBON	22K		
RT202	1-230-631-11	RES, ADJ, CARBON	22K		
RT203	1-230-625-11	RES, ADJ, CARBON	330		
RT204	1-230-631-11	RES, ADJ, CARBON	22K		
RT206	1-228-996-00	RES, ADJ, CARBON	47K		
RT207	1-228-996-00	RES, ADJ, CARBON	47K		
RT301	1-224-252-XX	RES, ADJ, METAL GLAZE	10K		
RT302	1-224-254-XX	RES, ADJ, METAL GLAZE	47K		
RT303	1-224-251-XX	RES, ADJ, METAL GLAZE	4.7K		
RT304	1-224-251-XX	RES, ADJ, METAL GLAZE	4.7K		
RT305	1-224-255-XX	RES, ADJ, METAL GLAZE	100K		
RT401	1-230-271-00	RES, ADJ, CARBON	4.7K		
RT402	1-228-996-00	RES, ADJ, CARBON	47K		
RY101	1-515-519-00	RELAY			
RY102	1-515-519-00	RELAY			

ELECTRICAL PARTS

Ref.No.	Part No.	Description
S701	1-554-303-21	SWITCH, KEY BOARD (1)
S702	1-554-303-21	SWITCH, KEY BOARD (2)
S703	1-554-303-21	SWITCH, KEY BOARD (3)
S704	1-554-303-21	SWITCH, KEY BOARD (4)
S705	1-554-303-21	SWITCH, KEY BOARD (5)
S706	1-554-303-21	SWITCH, KEY BOARD (6)
S707	1-554-303-21	SWITCH, KEY BOARD (7)
S708	1-554-303-21	SWITCH, KEY BOARD (8)
S709	1-554-303-21	SWITCH, KEY BOARD (9)
S710	1-554-303-21	SWITCH, KEY BOARD (10)
S711	1-554-303-21	SWITCH, KEY BOARD (FM/AM)
S712	1-554-303-21	SWITCH, KEY BOARD (IF-BAND)
S713	1-554-303-21	SWITCH, KEY BOARD (ANTENNA)
S714	1-554-303-21	SWITCH, KEY BOARD (TUNE MODE)
S715	1-554-303-21	SWITCH, KEY BOARD (MEMORY)
S716	1-554-303-21	SWITCH, KEY BOARD (SCAN READ)
S717	1-554-303-21	SWITCH, KEY BOARD (MUTE/MODE)
S718	1-554-303-21	SWITCH, KEY BOARD (CAL TONE)
S719	1-554-303-21	SWITCH, KEY BOARD (+)
S720	1-554-303-21	SWITCH, KEY BOARD (-)
S721	1-554-303-21	SWITCH, KEY BOARD (METER)
S851	1-553-318-00	SWITCH, PUSH (AC POWER) (1 KEY)
S852	1-570-600-11	SWITCH, ROTARY (PROGRAM)
TH201	1-800-199-00	THERMISTOR
TH202	1-800-378-00	THERMISTOR S-150
TH203	1-800-195-00	TH DIRECT-HEATING DISK
TH204	1-800-197-00	THERMISTOR S-400
TM851	1-537-026-11	TERMINAL BOARD (ANT)
TP201	*1-560-060-00	PIN, CONNECTOR 2P
TP202	*1-560-060-00	PIN, CONNECTOR 2P
TP301	*1-560-060-00	PIN, CONNECTOR 2P
TP302	*1-560-060-00	PIN, CONNECTOR 2P
TP401	*1-560-060-00	PIN, CONNECTOR 2P
TP851	*1-535-115-00	TERMINAL
TP852	*1-535-116-00	TERMINAL
TP853	*1-535-117-00	TERMINAL
TP854	*1-535-140-00	BASE POST 19MM (10MM PITCH) 3P
X501	1-567-125-00	VIBRATOR, CRYSTAL

ACCESSORY & PACKING MATERIAL

No.	Part No.	Description
101	4-908-060-51	INDIVIDUAL CARTON
102	4-915-426-01	CUSHION
103	4-858-078-00	SHEET, PROTECTION
104	1-501-353-11	ANTENNA, LOOP
105	1-558-787-31	CORD, CONNECTION
106	1-501-351-21	ANTENNA, FEEDER
107	1-417-090-00	TRANSFORMER, ANTENNA MATCHING
109	3-765-328-11	MANUAL, INSTRUCTION
110	3-701-630-00	BAG, POLYETHYLENE

The components identified by shading and mark  are critical for safety. Replace only with part number specified.