

# ST-515

Canadian Model  
AEP Model  
UK Model  
E Model



## FM-AM PROGRAM TUNER

### SPECIFICATIONS

#### GENERAL

<b>Power Requirements:</b>	120 V ac, 60 Hz (Canadian model) 120, 220 or 240 V ac adjustable 50/60 Hz (AEP, E model) 240 V ac, 50 Hz (UK model)
<b>Power Consumption:</b>	20 W (Canadian model) 24 W (AEP, E, UK model)
<b>Dimensions:</b>	Approx. 410 (w) x 145 (h) x 260 (d) mm 16 1/4 (w) x 5 3/4 (h) x 10 1/4 (d) inches Including projecting parts and controls
<b>*Weight:</b>	Approx. 5.7 kg, 12 lb 9 oz (net) Approx. 6.7 kg, 14 lb 12 oz (in shipping carton)

#### FM SECTION

<b>Antenna:</b>	300 $\Omega$ balanced 75 $\Omega$ unbalanced
<b>Tuning Range:</b>	87.5 – 108 MHz
<b>Intermediate Frequency:</b>	10.7 MHz
<b>Sensitivity at 46dB</b>	
<b>  Quieting:</b>	4.0 $\mu$ V (MONO) 50 $\mu$ V (STEREO) (40kHz deviation)
<b>Usable Sensitivity:</b>	1.7 $\mu$ V, S/N = 26 dB (40kHz deviation) 19 $\mu$ V, 10.7 dBf; IHF
<b>S/N Ratio:</b>	75 dB (MONO) 70 dB (STEREO)
<b>Harmonic Distortion:</b>	at 100 Hz 0.15 % (MONO) 0.25 % (STEREO) at 1 kHz 0.15 % (MONO) 0.25 % (STEREO) at 10 kHz 0.2 % (MONO) 0.5 % (STEREO)

#### SAFETY-RELATED COMPONENT WARNING!!

COMPONENTS IDENTIFIED BY SHADING AND MARK  ON THE SCHEMATIC DIAGRAMS, EXPLODED VIEWS AND IN THE PARTS LIST ARE CRITICAL TO SAFE OPERATION. REPLACE THESE COMPONENTS WITH SONY PARTS WHOSE PART NUMBERS APPEAR AS SHOWN IN THIS MANUAL OR IN SUPPLEMENTS PUBLISHED BY SONY.

ATTENTION AU COMPOSANT AYANT RAPPORT  
À LA SÉCURITÉ !

LES COMPOSANTS IDENTIFIÉS PAR UN TRAMÉ ET UNE MARQUE  SUR LES DIAGRAMMES SCHEMATIQUES, LES VUES EXPLOSÉES ET LA LISTE DES PIÈCES SONT CRITIQUES POUR LA SÉCURITÉ DE FONCTIONNEMENT. NE REMPLACER CES COMPOSANTS QUE PAR DES PIÈCES SONY DONT LES NUMÉROS SONT DONNÉS DANS CE MANUEL OU DES SUPPLÉMENTS PUBLIÉS PAR SONY.

— Continued on page 2 —

**SONY**<sup>®</sup>  
**SERVICE MANUAL**



SECTION 1  
OUTLINE

1-1. BLOCK DIAGRAM *Canadian Model*

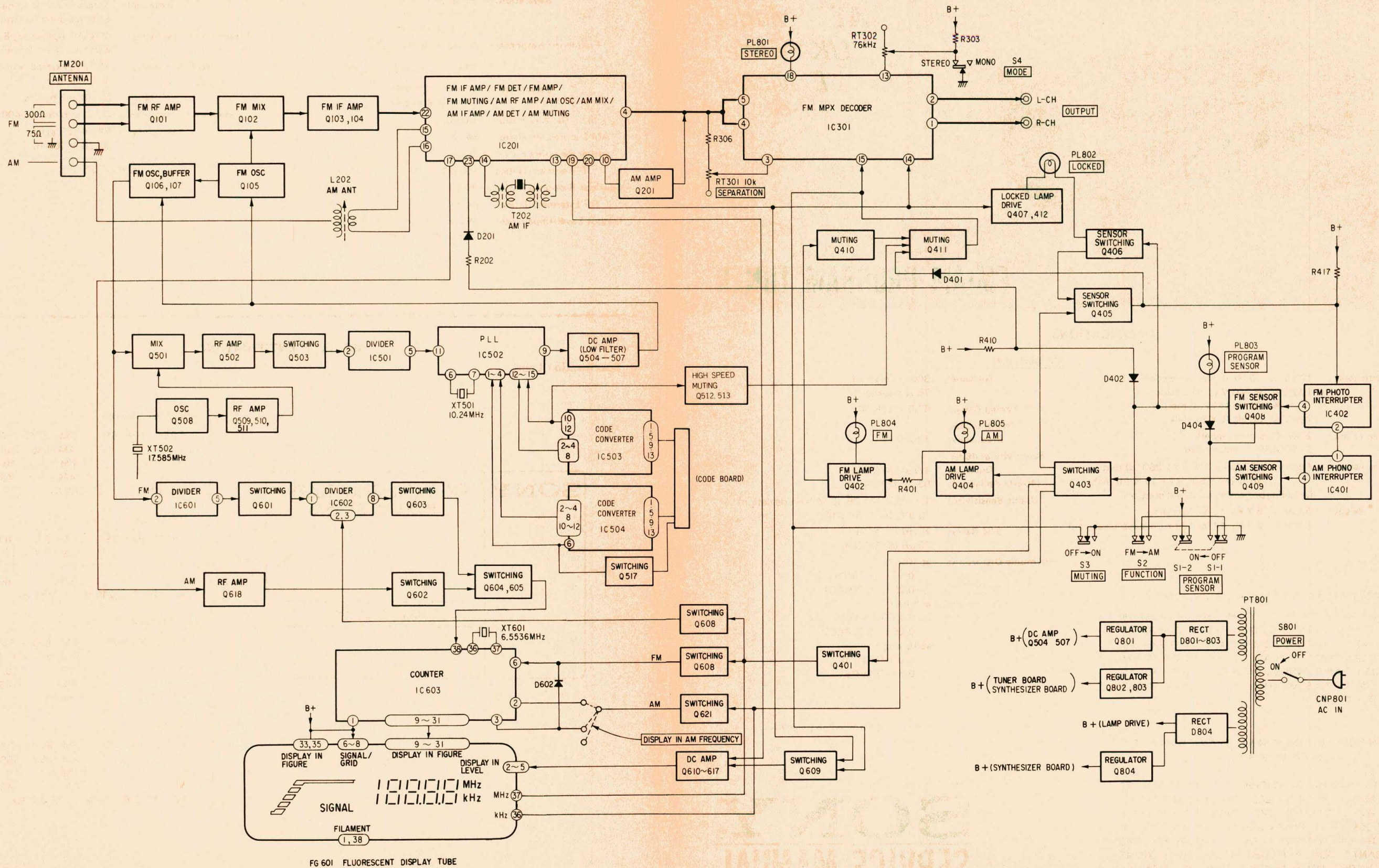



**IM Distortion:** 0.15 % (MONO)  
 0.25 % (STEREO)  
**Separation:** 35 dB at 100 Hz  
 45 dB at 1 kHz  
 40 dB at 10 kHz  
**Frequency Response:** 30 Hz – 15 kHz  $\begin{matrix} +0.15 \\ -2.0 \end{matrix}$  dB  
 40 Hz – 12.5 kHz  $\begin{matrix} +0.5 \\ -1.0 \end{matrix}$  dB  
**Selectivity:** 40 dB at 300 kHz  
 60 dB at 400 kHz  
**Capture Ratio:** 1.0 dB  
**AM Suppression Ratio:** 54 dB  
**Image Response Ratio:** 80 dB  
**IF Response Ratio:** 100 dB  
**Spurious Response Ratio:** 90 dB  
**RF Intermodulation:** 60 dB  
**Output Level/Impedance:** 450 mV, 6.8 k $\Omega$  at 1 kHz deviation  
 100 % modulation

## AM TUNER SECTION

**Frequency Range:** 530 – 1,605 kHz  
**Antenna:** Attached AM antenna wire  
 External antenna terminal  
**Intermediate Frequency:** 455 kHz (Canadian, E model)  
 468 kHz (AEP, UK model)  
**Usable Sensitivity:** 100  $\mu$ V, external antenna  
 at 1,000 kHz  
**S/N Ratio:** 52 dB at 5 mV/m  
**Harmonic Distortion:** 0.3 % at 5 mV/m, 400 Hz  
**Selectivity:** 28 dB at 9 kHz  
 30 dB at 10 kHz

0 dB = 0.775 V

## MODEL IDENTIFICATION

### Specification Label

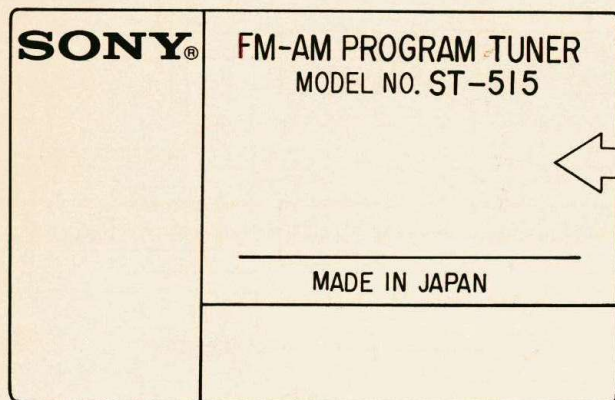

#### – Canadian Model –

**FREQ. RANGE** : FM 87.5 – 108 MHz  
 AM 530 – 1605 kHz  
**IF** : FM 10.7 MHz  
 AM 455 MHz  
**AC 120 V** 60 Hz 20 W

#### – AEP Model –

**FREQ. RANGE** : FM 87.5 – 108 MHz  
 AM 530 – 1605 kHz  
**IF** : FM 10.7 MHz  
 AM 468 kHz  
**AC 120, 220, 240 V**  $\sim$  50 Hz 24 W

#### – UK Model –

**FREQ. RANGE** : FM 87.5 – 108 MHz  
 AM 530 – 1605 kHz  
**IF** : FM 10.7 MHz  
 AM 468 kHz  
**AC 240 V**  $\sim$  50 Hz 24 W

#### – E Model –

**FREQ. RANGE** : FM 87.5 – 108 MHz  
 AM 530 – 1605 kHz  
**IF** : FM 10.7 MHz  
 AM 455 kHz  
**AC 120, 220, 240 V**  $\sim$  50/60 Hz 24 W



1-2. BLOCK DIAGRAM AEP, UK, E Model

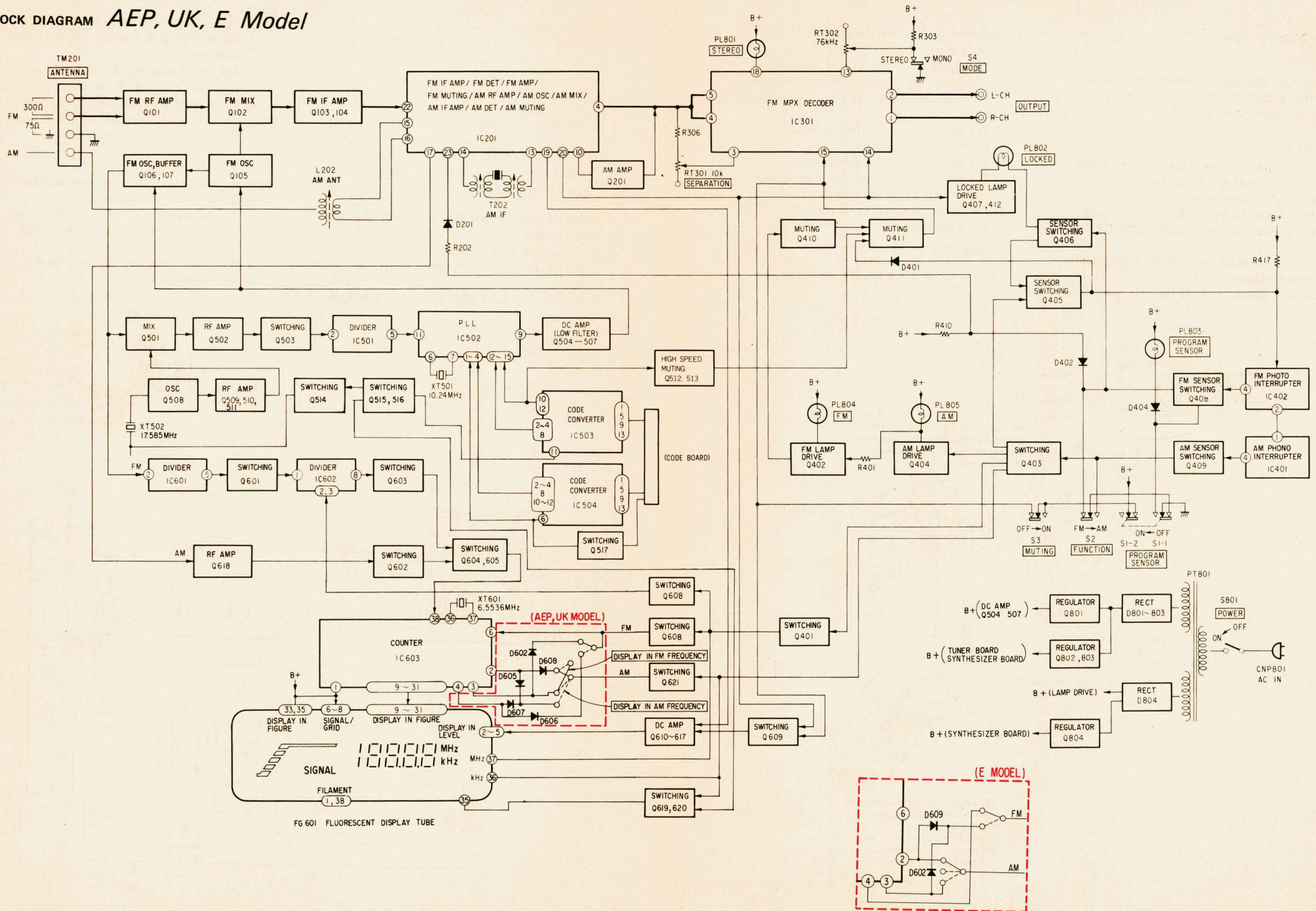



1-3. CIRCUIT DESCRIPTION

Program Sensor

The FM or AM band can be changed automatically through the optical detection when the pointer matches to the desired station marker.

Marker Setting

1. Match the pointer to the upper marker (at FM station) or the bottom marker (at AM station) while turning TUNING knob.
2. Slide the station marker with the pointer while pushing FM switch (or AM switch) of PROGRAM in.
3. Set free the PROGRAM switch at the tuning point to the desired station.
4. The station marker is fixed in this position.

1) When the pointer matches only with the FM station marker:

- a) The light of IC402 (Photo Interrupter) is intercepted by the marker, the impedance between terminals 3 and 4 of IC402 becomes high.
- b) The base voltage of Q408 is increased through R415 and Q408 turns on.
- c) The cathode of D402 is grounded.
- d) The B+ voltage through R410 is not supplied to the terminal 23 of IC201.
- e) FM circuit operates (The terminal 23 of IC201 serves as a switch).

**Note:** When B+ voltage is supplied to the terminal 23, the receiver is in AM mode. When B+ voltage is not supplied, the receiver is in FM mode.

- f) The impedance between terminals 3 and 4 of IC401 becomes low. So, Q409, Q403 and Q404 turn off, Q402 turns on. Then, PL804 (FM indicator lamp) lights.
- g) The collector voltage of Q408 reduces, Q406 and Q405 turn on.
- h) The positive feedback is applied to the terminal 1 of IC402, the circuit operates correctly.
- i) Q411 is used as muting when the station marker does not match to the pointer. Namely, Q405 turns on, and Q411 turns off.

2) When the pointer matches only with the AM station marker:

- a) As the light of IC402 is not intercepted, the B+ voltage is supplied to the terminal 23 of IC201.
- b) On the other hand, the light of IC401 is inter-

cepted, Q409 and Q403 turn on. As a result, the B+ voltage is supplied to L203 (AM oscillator coil).

- c) AM circuit operates. At the same time, Q404 turns on, PL805 (AM indicator lamp) lights.
- d) The positive feedback is applied to the terminal 1 of IC401 because of Q405 operating, the circuit operates correctly.

3) When the pointer matches simultaneously with both the FM and AM station markers:

- a) As the lights of IC401 and IC402 are not intercepted simultaneously, Q408 and Q406 turn on.
- b) D405 and Q409 turn off, only the FM station signal is received.

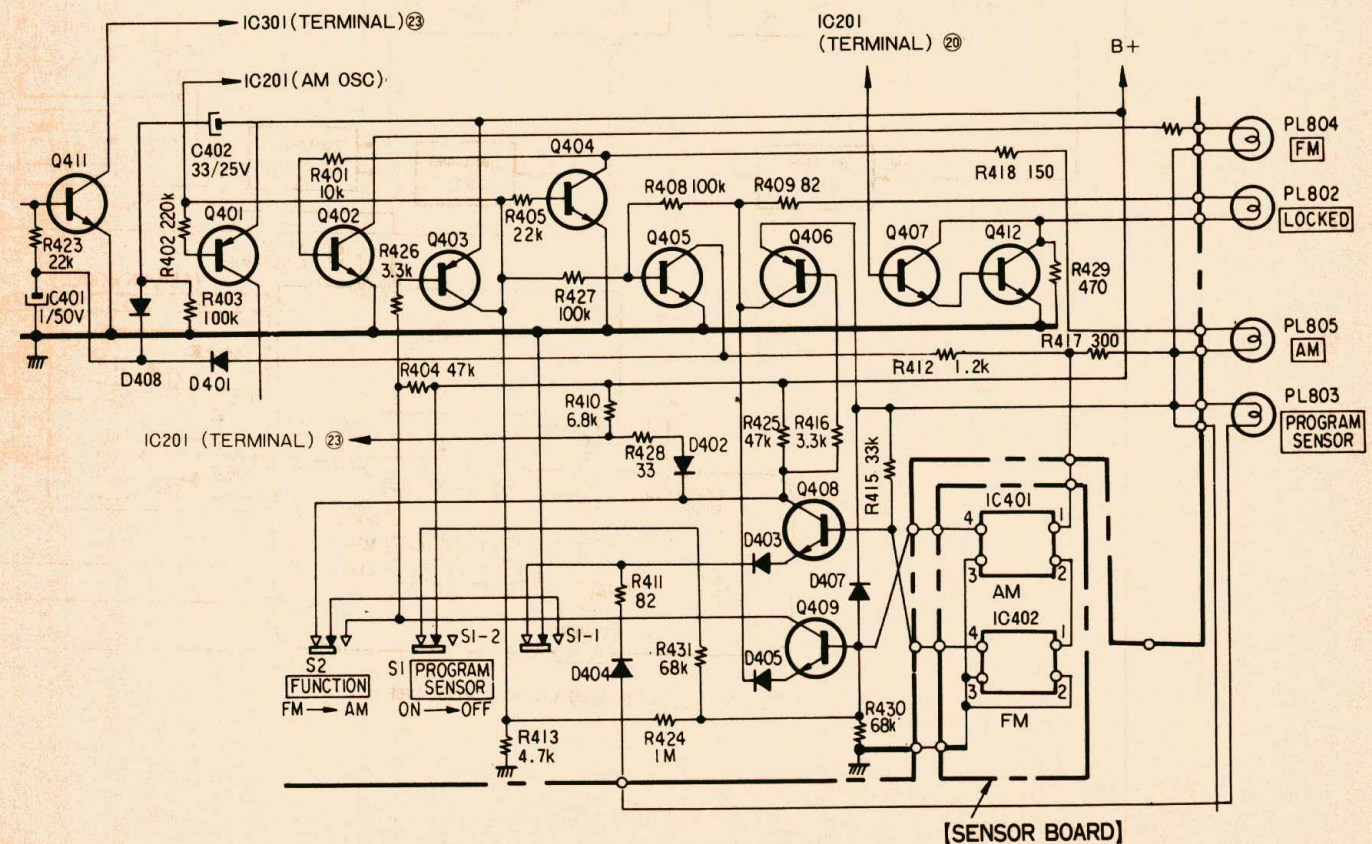
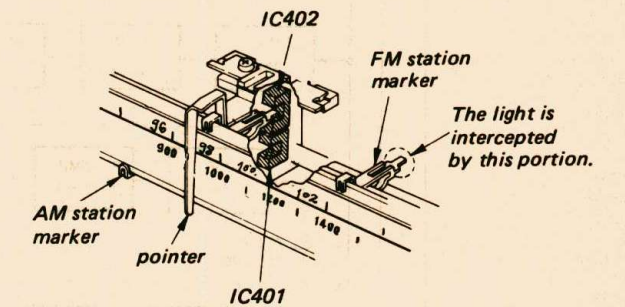
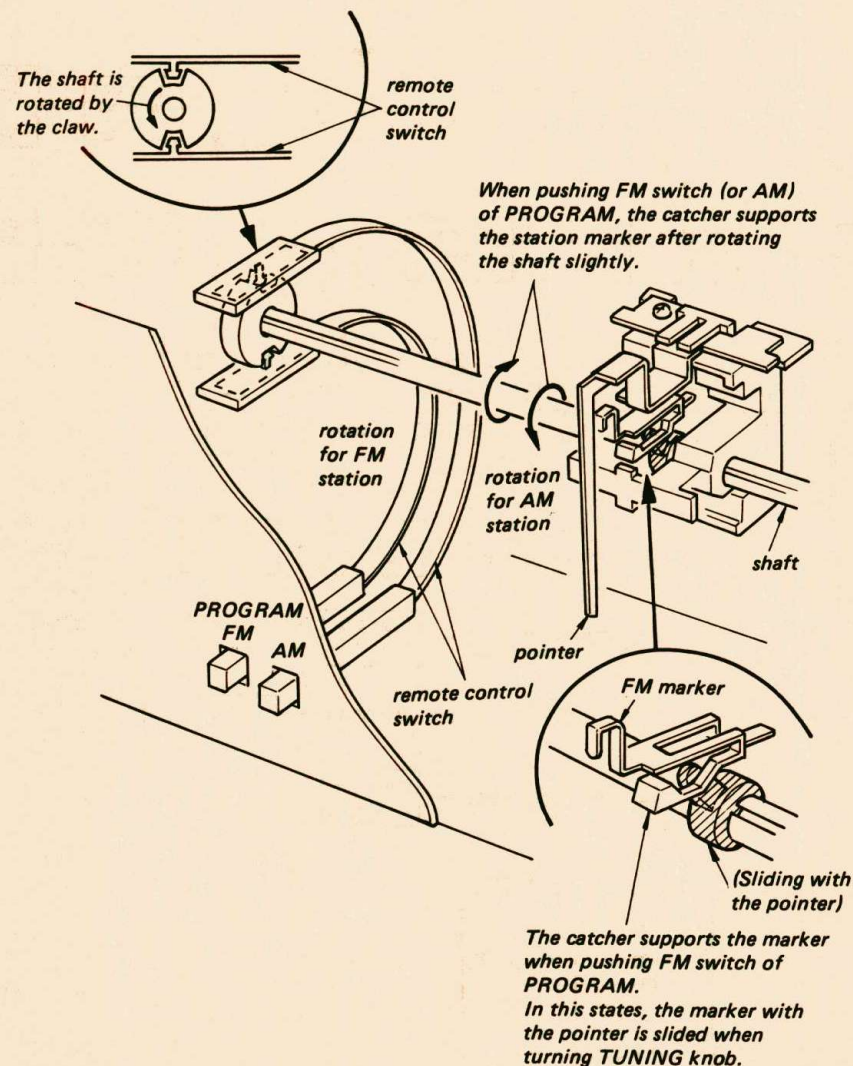







## SECTION 2 DISASSEMBLY

### 2-1. REMOVAL

Note: Follow the disassembly procedure in the numerical order given.

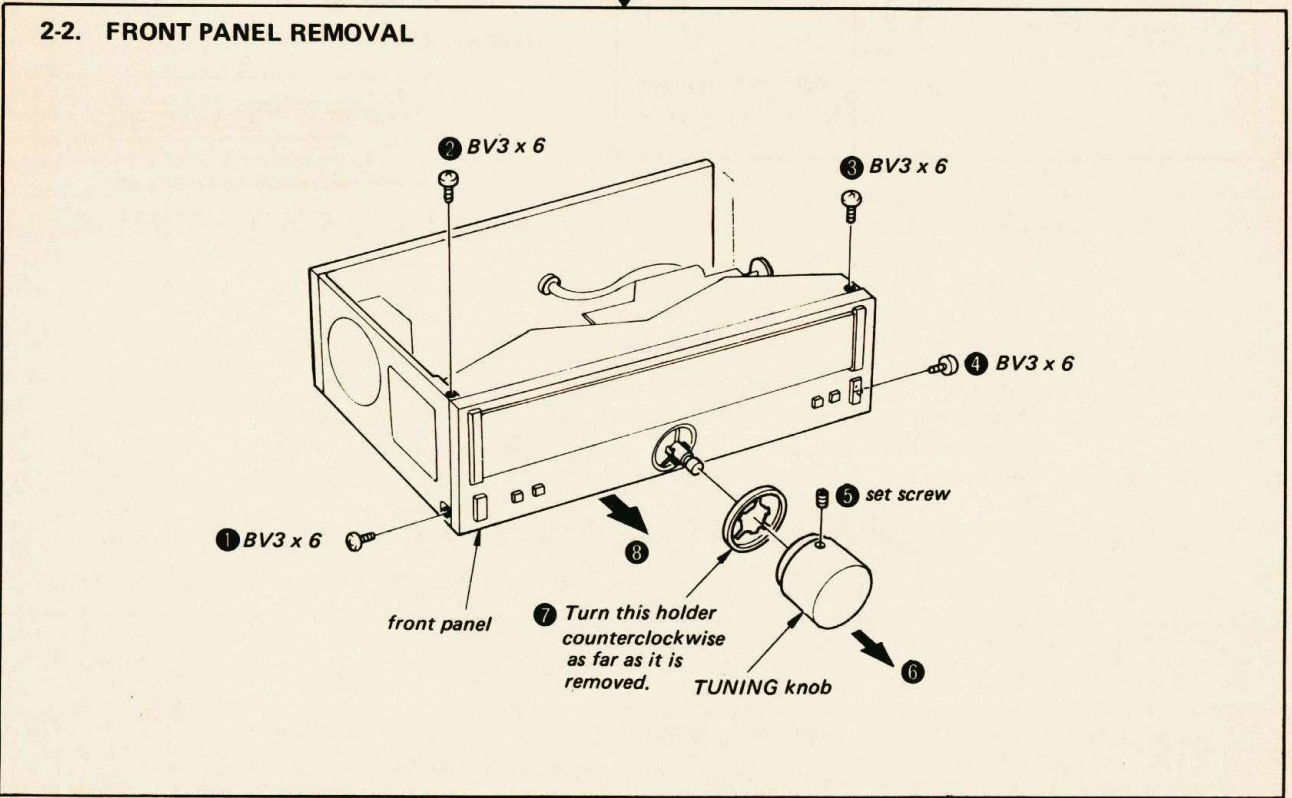
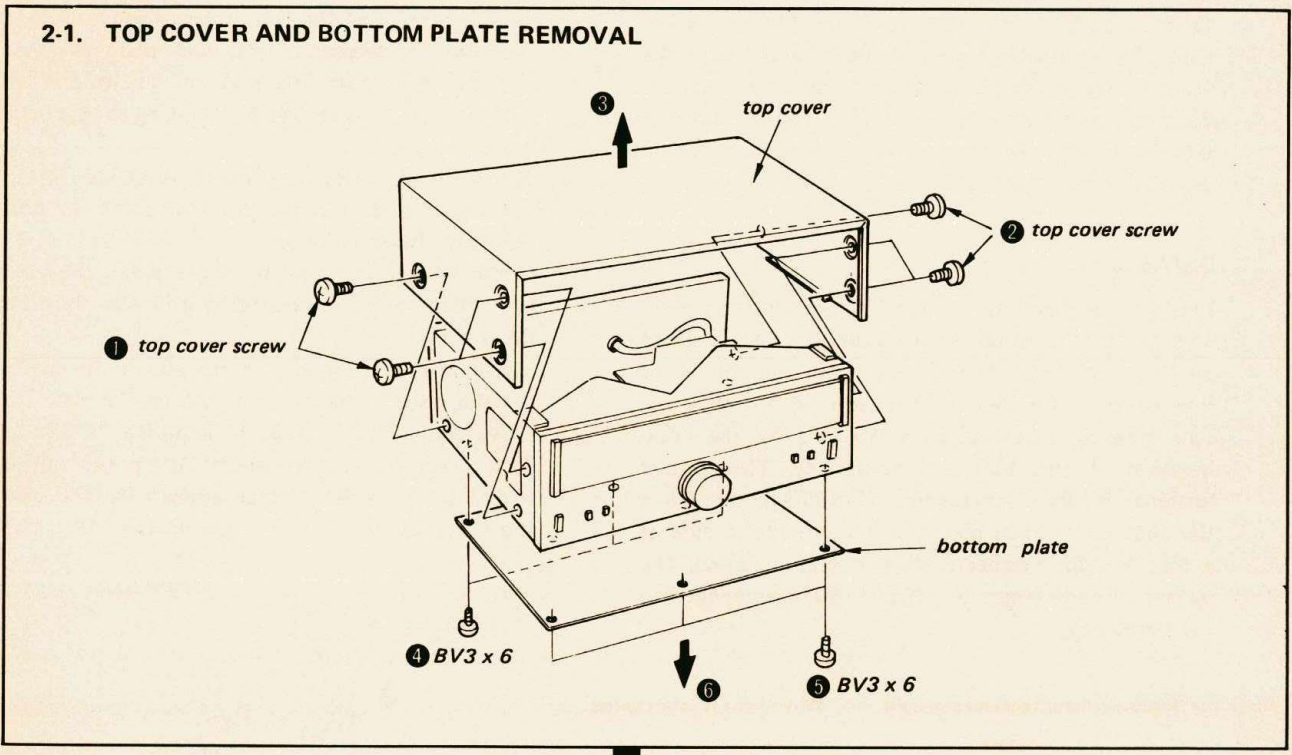



2-2. DIAL CORD STRINGING

1) Preparation

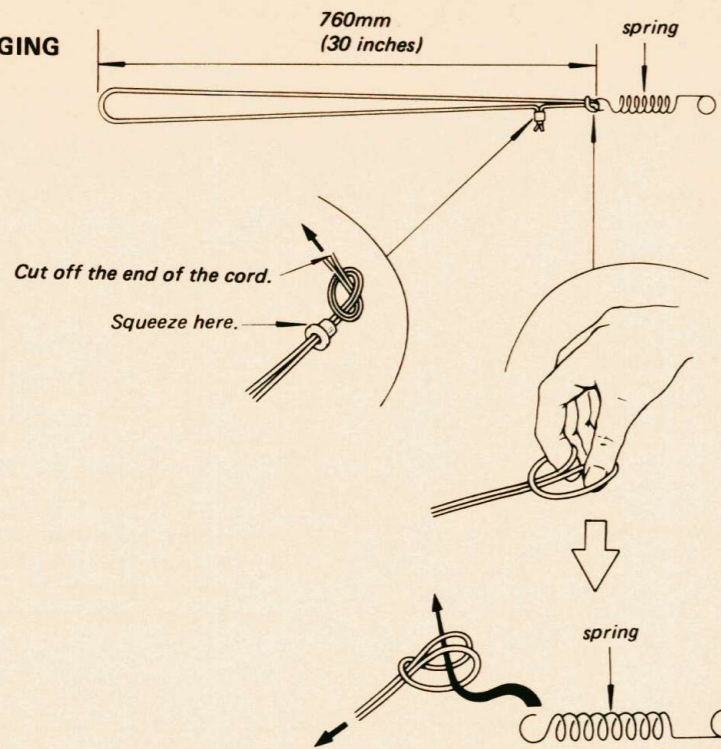

2) Stringing

Turn the tuning capacitor shaft fully clockwise and set the tuning drum so that the cutout is positioned as shown.

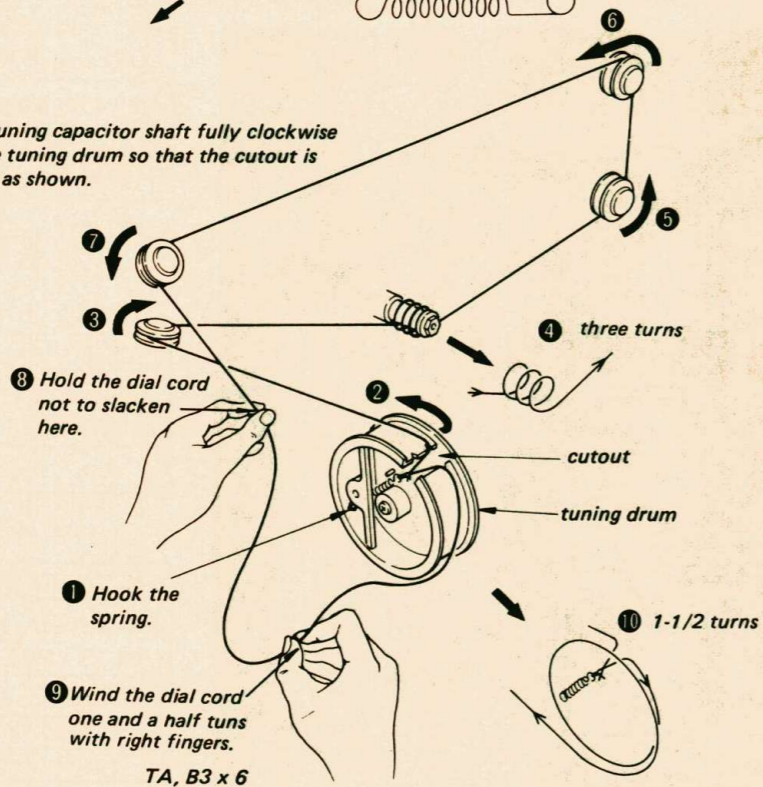

3) Dial Pointer Installation

1 Tune the receiver to the off-the-air signal and set the dial pointer to the frequency of the dial scale.

TA, B3 x 6

3 Install the dial pointer with a TA, B3 x 6 screw.

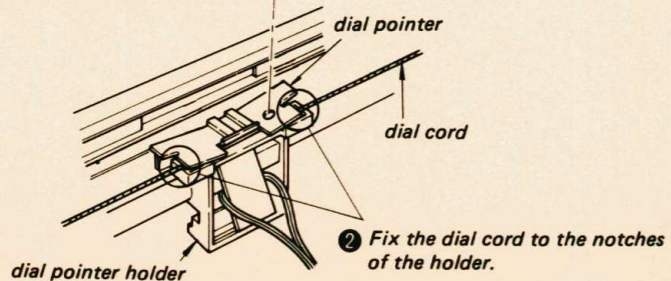

MEMO

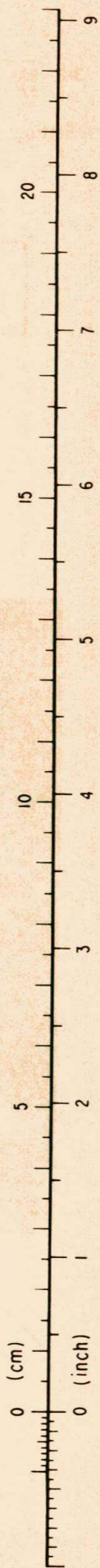



SECTION 3  
ADJUSTMENTS

3-1. AM SECTION

Setting: FUNCTION Selector: AM  
MODE Selector: MONO



- Repeat the procedures in each adjustment several times, and the frequency coverage and tracking adjustments should be finally done by the trimmer capacitors.

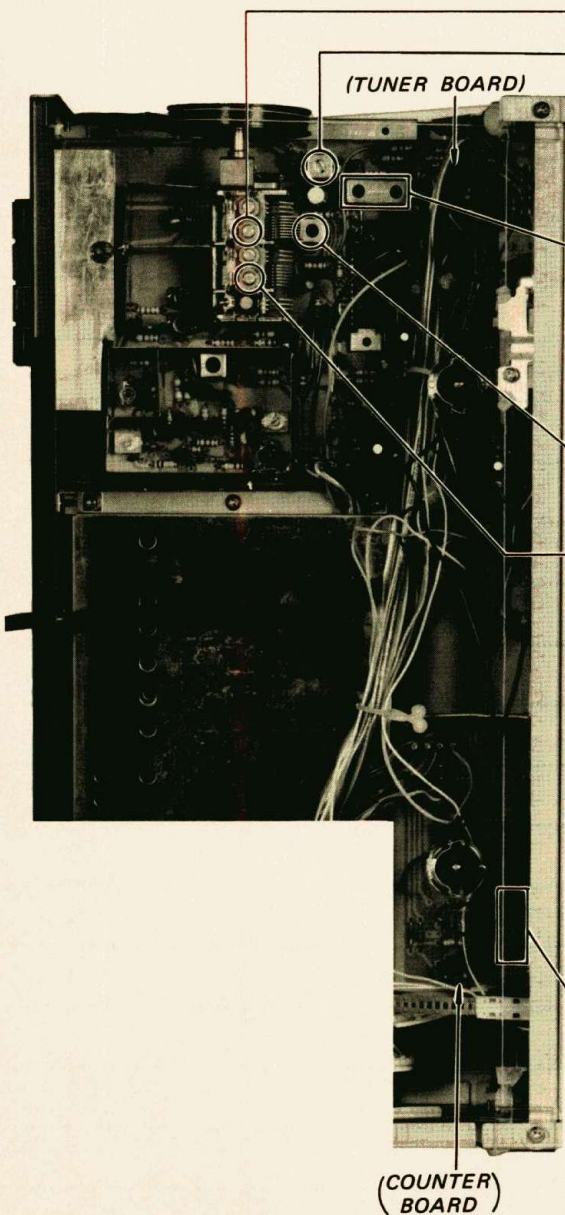

AM TRACKING ADJUSTMENT	
Adjust for a maximum reading on VTVM.	
TC104	1400 kHz
L202	600 kHz

AM IF ALIGNMENT	
Adjust for a maximum reading on VTVM.	
T202	455 kHz (Canadian, E Model)
	468 kHz (AEP, UK Model)

AM FREQUENCY COVERAGE ADJUSTMENT	
Adjust for a maximum reading on VTVM.	
L203	600 kHz
TC105	1400 kHz

**AM Indication Adjustment (Proceed this adjustment after AM IF alignment)**

- Procedure:**
- Supply a 600 kHz or 1400 kHz signal to set from an AM signal generator.
  - Change the jumper wire for a maximum reading on the level meter.

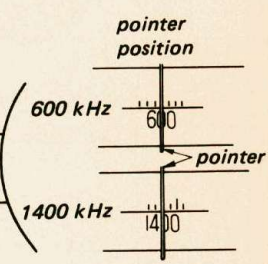
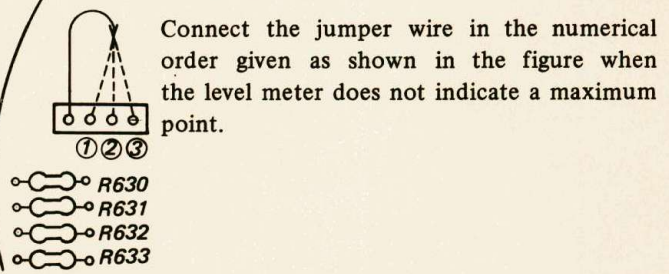

3-2. FM SECTION

Setting: FUNCTION Selector: FM  
MODE Selector: MONO



- Repeat the procedures in each adjustment several times, and the frequency coverage and tracking adjustments should be finally done by the trimmer capacitors.

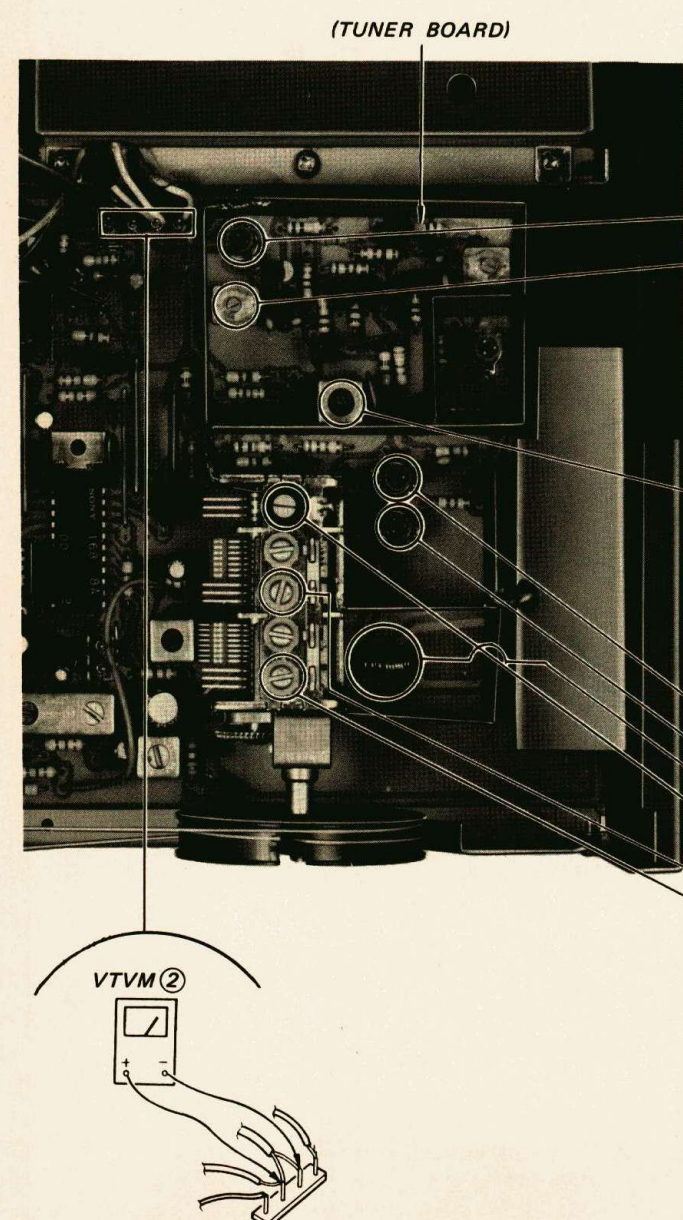

FM FREQUENCY COVERAGE ADJUSTMENT	
Adjust for a maximum reading on VTVM ①.	
L106	87.6 MHz
CT102	108 MHz

FM IF ALIGNMENT	
Adjust for a maximum reading on VTVM ②.	
T101	10.7 MHz

FM TRACKING ADJUSTMENT	
Adjust for a maximum reading on VTVM ①.	
L104	87.6 MHz
L103	
L102	
CT103	108 MHz
CT106	
CT107	

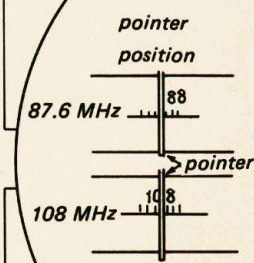



FM SECTION

FM STEREO SEPARATION ADJUSTMENT

Setup:

FUNCTION selector: FM  
MODE selector: STEREO

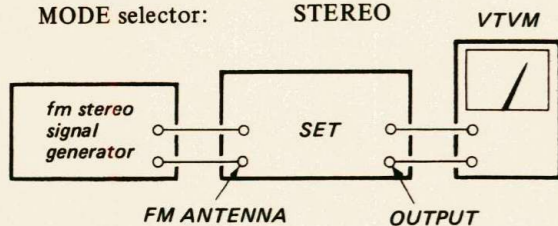

FM Stereo Signal Generator Setting:

Carrier frequency: 98 MHz  
Output level: 1 mV (60 dB)  
Mode: Stereo  
Modulation:  
Audio (400 Hz): 67.5 kHz deviation (90%)  
Pilot (19 kHz): 7.5 kHz deviation (10%)  
Sub channel (38 kHz): 67.5 kHz deviation (90%)

Procedure:

FM stereo signal generator output channel	VTVM connection	VTVM reading
L-CH	L-CH	(A)
R-CH	L-CH	(B) Adjust RT301 for minimum reading.
R-CH	R-CH	(C)
L-CH	R-CH	(D) Adjust RT301 for minimum reading.

Readjust RT301 for minimum difference between left channel separation ((A) - (B)) and right channel separation ((C) - (D)).

DISCRIMINATOR ADJUSTMENT

Setup:

FUNCTION selector: FM  
MODE selector: MONO

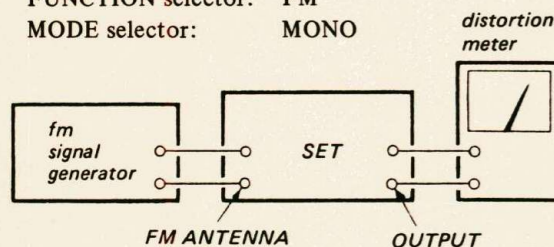

FM Signal Generator Setting:

Carrier frequency: 98 MHz  
Modulation: 400 Hz, 75 kHz deviation (100%)  
Output level: 1 mV (60 dB)

Procedure:

- Secondary-Side of T201  
Tune the set to 98 MHz and adjust the secondary-side core (black) of T201 for minimum reading on the distortion meter.
- Primary-Side of T201
  - Detune the set.
  - Adjust the primary-side core (blue) of T201 for zero reading on the VOM.

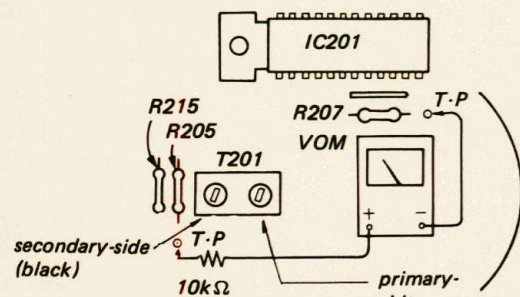

(Perform this procedure when replacing ceramic filter (CF201)).

- Repeat the above steps 1 and 2 several times.

RT301

(TUNER BOARD)

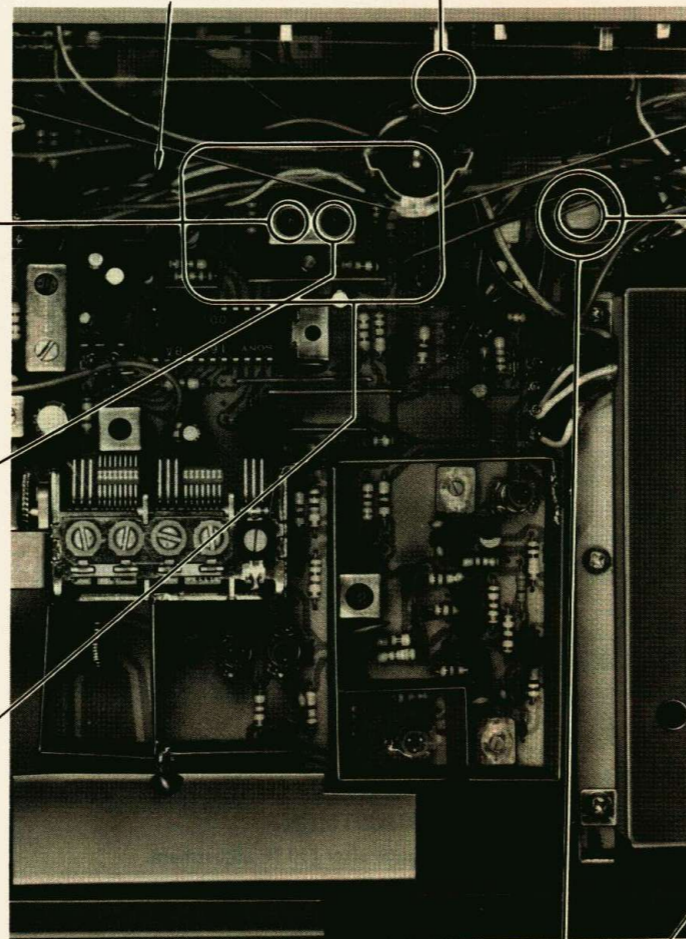

T201 primary-side core (blue)

T201 secondary-side core (black)

76 kHz ADJUSTMENT

Setup: FUNCTION selector: FM  
MODE selector: STEREO

A) Regular Method

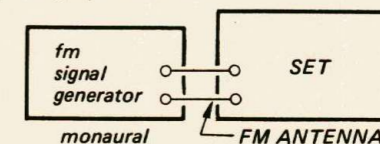

FM Signal Generator Setting:

Carrier frequency: 98 MHz  
Modulation: no modulation  
Output level: 1 mV (60 dB)

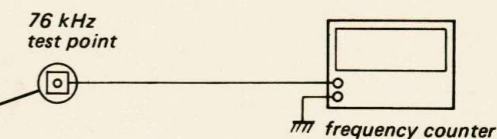

Procedure:

- Tune the set to 98 MHz.
- Adjust RT302 for 76 kHz ± 100 Hz on the counter.

B) Simple Method

Procedure:

- Tune the set to the FM stereo station signal.
- Turn RT302 clockwise or counterclockwise and memorize the lighting-up range of STEREO lamp.
- Secure RT302 at the center in lighting-up range of both turns as shown below.

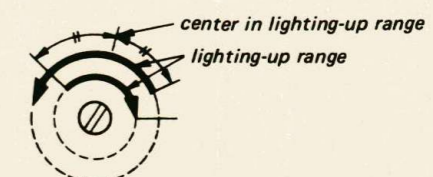

76kHz test point

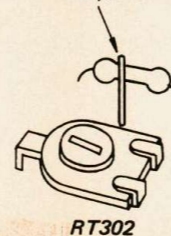



**FM SECTION**

**PLL FREQUENCY ADJUSTMENT**

(This adjustment should be made after the discriminator adjustment mentioned on page 15.)

**Setup:**

FUNCTION selector: FM  
MODE selector: STEREO

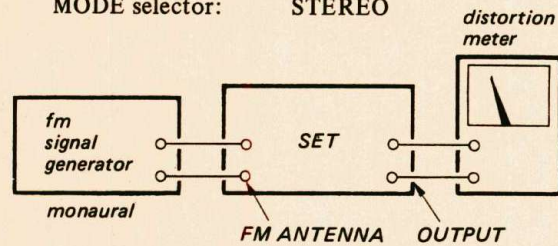

**FM Signal Generator Setting:**

Carrier frequency: 98 MHz  
Modulation: 400 Hz, 75 kHz deviation (100 %)  
Output level: 1 mV (60 dB)

**Procedure:**

1. Tune the set to 98 MHz and adjust CT501 (AEP, UK, E Model) and CT502 for zero reading on the VOM.
2. Secondary-Side of T201
  - 1) Detune the set.
  - 2) Adjust the secondary-side core (black) of T201 for minimum reading on the distortion meter.

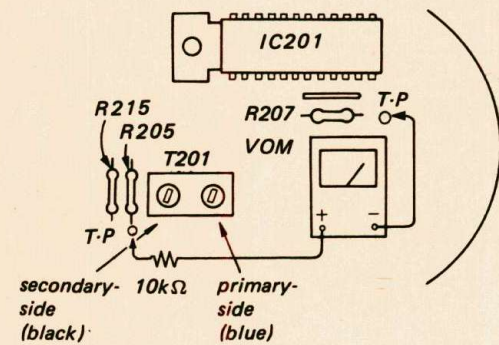

3. Repeat the above steps 1 and 2 several times.

Setting: FUNCTION selector: FM  
MODE selector: STEREO

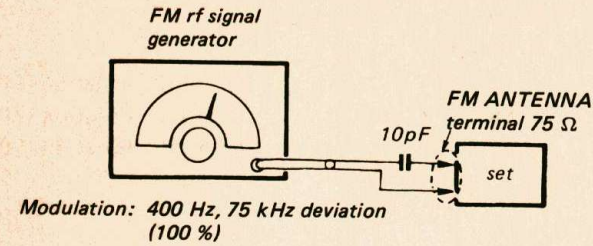

PLL ALIGNMENT (2)	
Adjust for a maximum reading on VOM ①.	
L505	132.1 MHz
L506	
L507	
L509	

CT501 (AEP, UK, E Model)

CT502

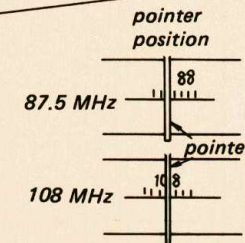
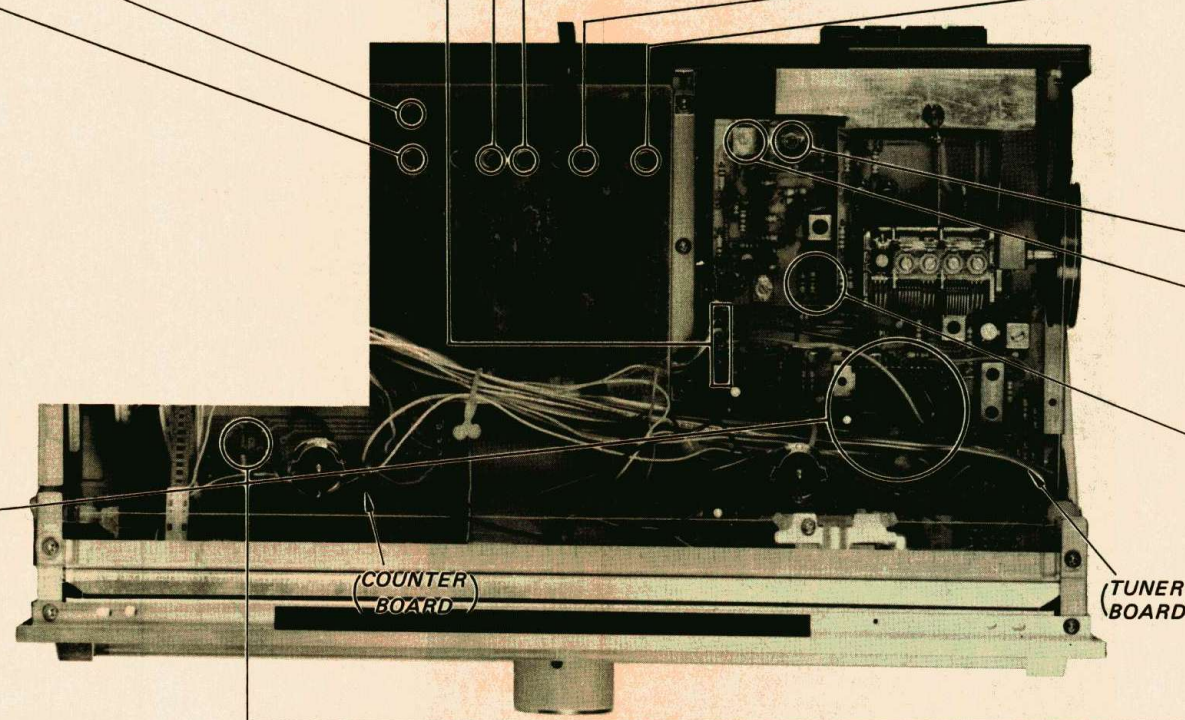

PLL ALIGNMENT (1)		
L105	87.5 MHz	Adjust for a 3 V reading on VOM ②.
CT101	108 MHz	Adjust for a 22 V reading on VOM ②.
Repeat the above steps L105 and CT101 several times.		

(AEP, UK, E Model)

**FM FREQUENCY DISPLAY ADJUSTMENT**

Note: This adjustment should be made after FM IF adjustment.

1. Detune the set.
2. Connect the frequency counter to the emitter of Q104.
3. Solder the jumper wire to A point when the frequency is less than 10.7 MHz.
4. Solder the jumper wire to B point when the frequency is more than 10.7 MHz.

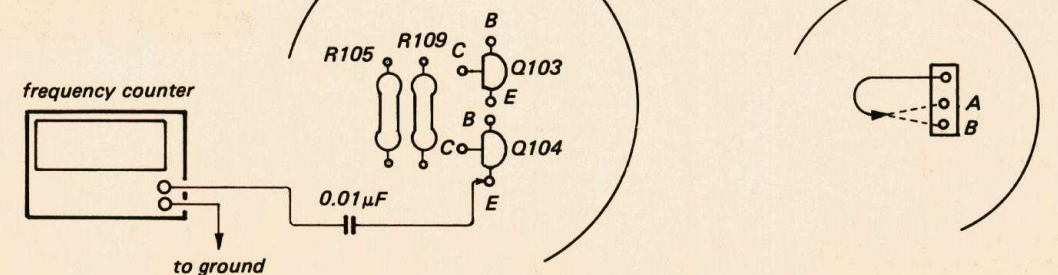



SECTION 4  
DIAGRAMS

4-1. MOUNTING DIAGRAM — Counter Board —  
— Conductor Side —

Canadian Model

Canadian Model

Replacement Semiconductors

For replacement, use semiconductors except in ( ).

IC201: CX168

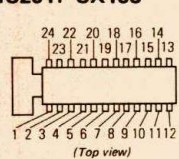

Q101: 2SK42-3

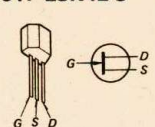

Q505, 506: 2SA872-D (2SA705)

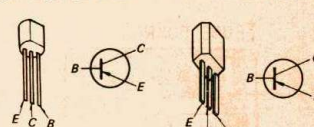

D804: 51VB10

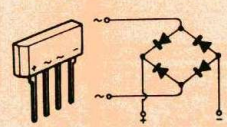

IC301: CX178

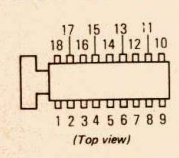

Q102, 618: 2SK23A-834

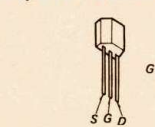

Q515, 516: 2SC1364 (2SC945)

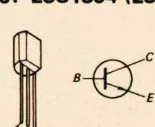

D805: EQB01-30 (EQA01-30R)

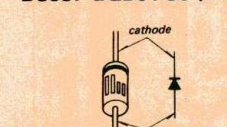

IC401, 402: SPI201

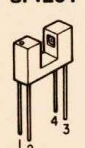

Q103-107, Q501, 502, Q508-510, Q602 : 2SC710

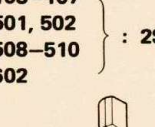

Q802, 804: 2SC1061 (2SC1419)

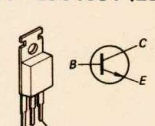

D806: EQB01-06 (EQA01-06R)

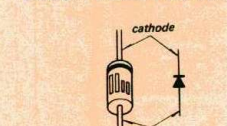

IC501, 602: M53290P (μPB551C)

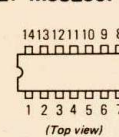

Q201, 402, Q404, 405, Q407-410, Q411, 412, Q511, 512, Q513-517, Q601 : 2SC1364 (2SC945)

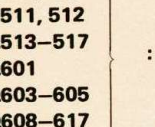

Q803: 2SC1061

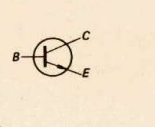

IC502: MSM5807

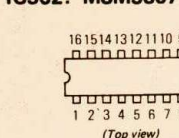

Q201, 402, Q404, 405, Q407-410, Q411, 412, Q511, 512, Q513-517, Q601 : 2SC1364 (2SC945)

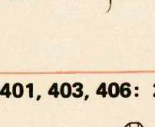

D101, 102: 1SV55

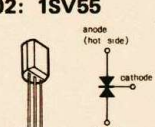

IC503, 504: MSM4030

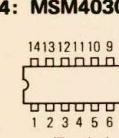

Q401, 403, 406: 2SA678 (2SA844)

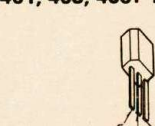

D201, 202, D301, 303, D401-405, D408-409, D501, D602-609, D807 : 1S1555 (1T40)

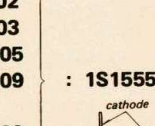

IC601: μPB551C

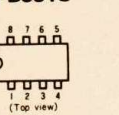

Q503: 2SC641K

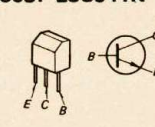

D601: EQB01-09

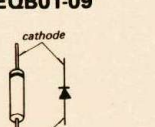

IC603: MSM5525

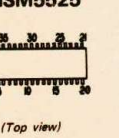

Q504, 507: 2SK23A-940 (2SK23)

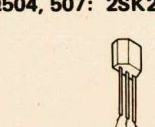

D801-803: 10E2 (RA-12)

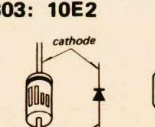

Refer to P. 25 for the AEP, UK, E Model.

D	603	602
Q	604	608
IC	IC603	621 608

1

2

3

4

5

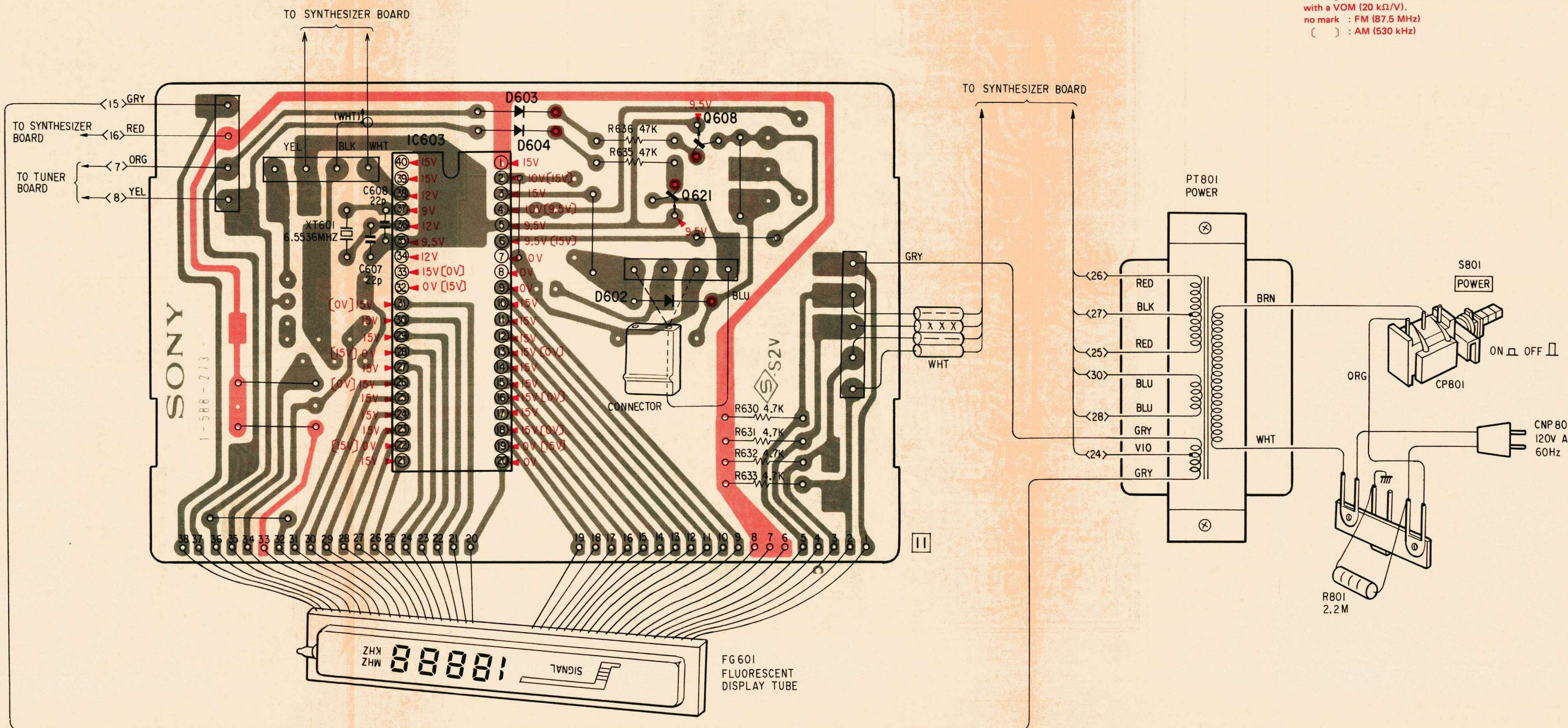

Note:  
 • [Red box] : adjustment for repair.  
 • [Red dot] : B+ pattern.  
 • Readings are taken under no signal (detuned) conditions with a VOM (20 kΩ/V).  
 no mark : FM (87.5 MHz)  
 [ ] : AM (530 kHz)



4-2. MOUNTING DIAGRAM — Tuner, Synthesizer, Counter, Photo interrupter, Code and Fuse Board —  
Conductor Side —

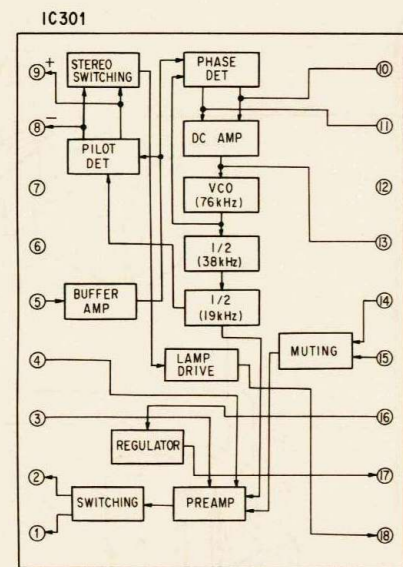
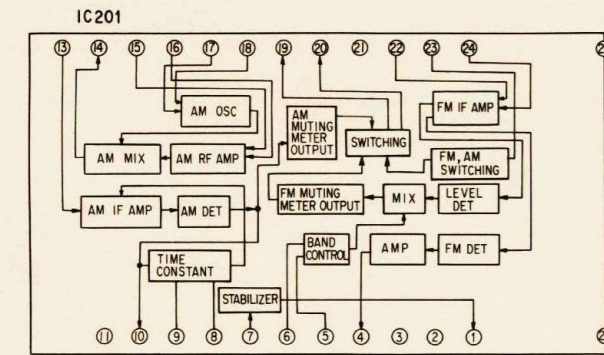

D	Q, IC
102	105
101	106
107	107
102	103
104	104
201	409 407
402	412
IC201	202
IC301	410
406	411
404	401
401	402
408 302	401 408
403	406
404	405
405	409
D	Q, IC

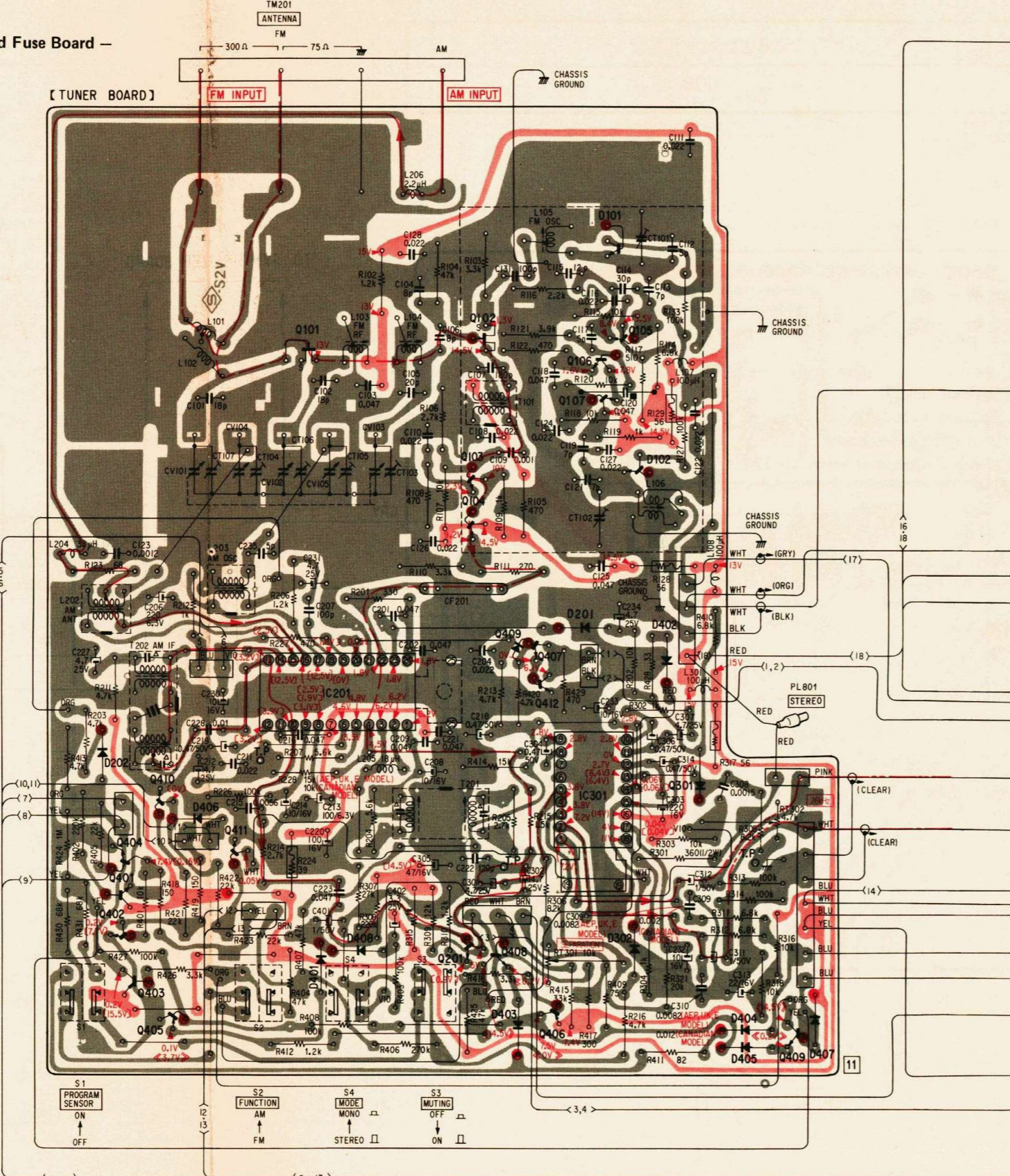

D	Q, IC	D	Q, IC
511	510	807	806
IC601	IC602	806	804
601	603	501	803
		802	802
		801	801
		517	805
		609	613
		612	611
		615	610
		614	
		618	
		619	
		620	
		621	
		622	
		623	
		624	
		625	
		626	
		627	
		628	
		629	
		630	
		631	
		632	
		633	
		634	
		635	
		636	
		637	
		638	
		639	
		640	
		641	
		642	
		643	
		644	
		645	
		646	
		647	
		648	
		649	
		650	
		651	
		652	
		653	
		654	
		655	
		656	
		657	
		658	
		659	
		660	
		661	
		662	
		663	
		664	
		665	
		666	
		667	
		668	
		669	
		670	
		671	
		672	
		673	
		674	
		675	
		676	
		677	
		678	
		679	
		680	
		681	
		682	
		683	
		684	
		685	
		686	
		687	
		688	
		689	
		690	
		691	
		692	
		693	
		694	
		695	
		696	
		697	
		698	
		699	
		700	

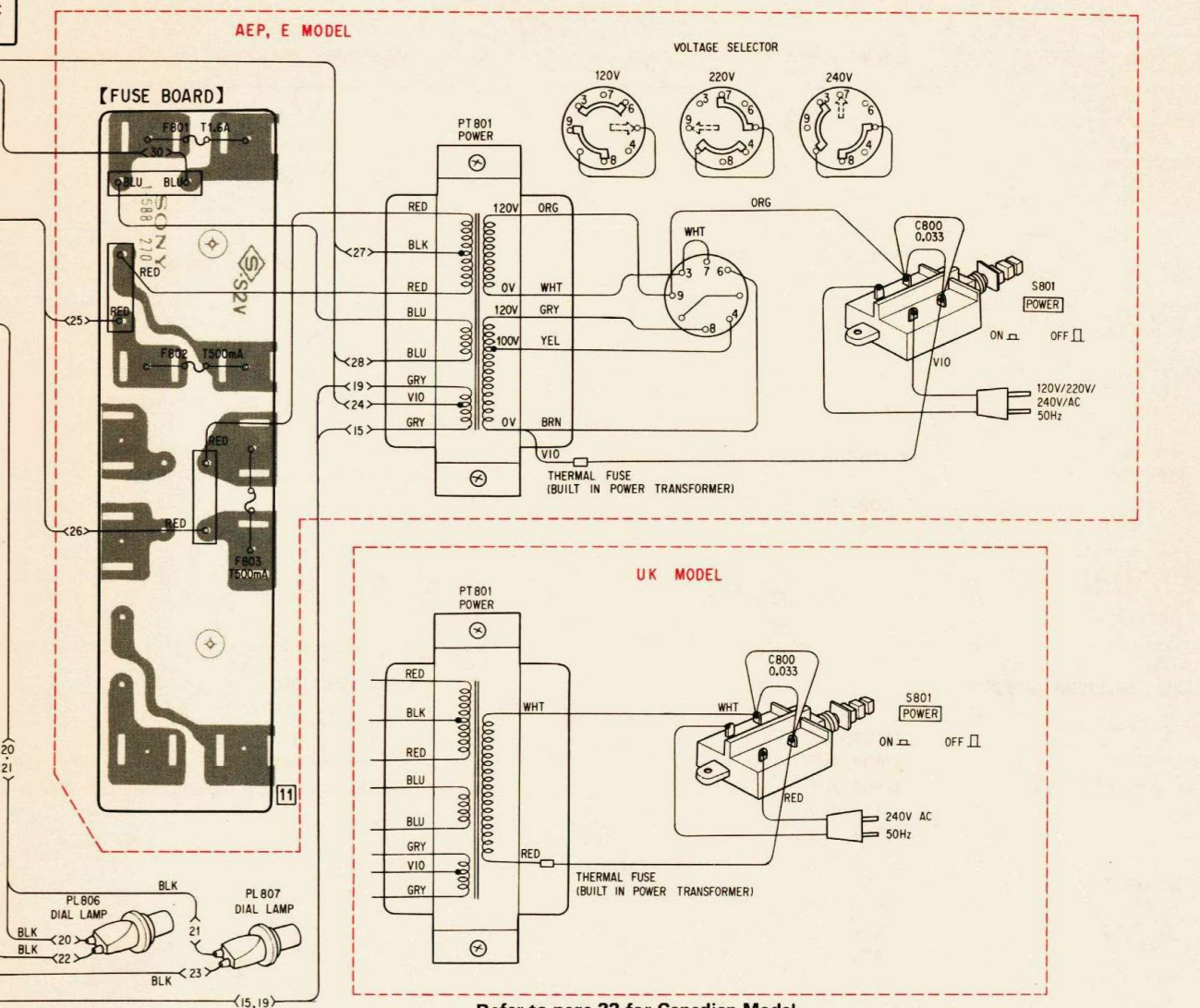
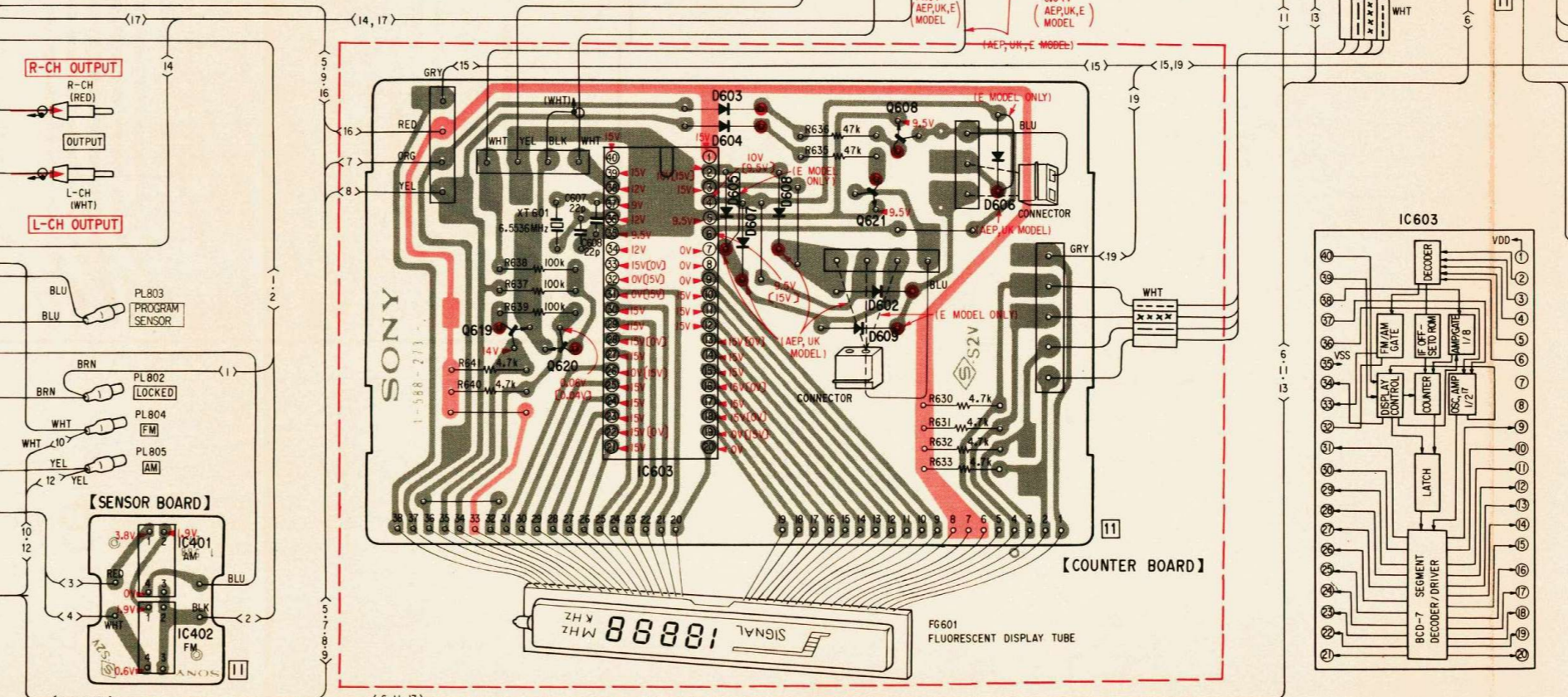
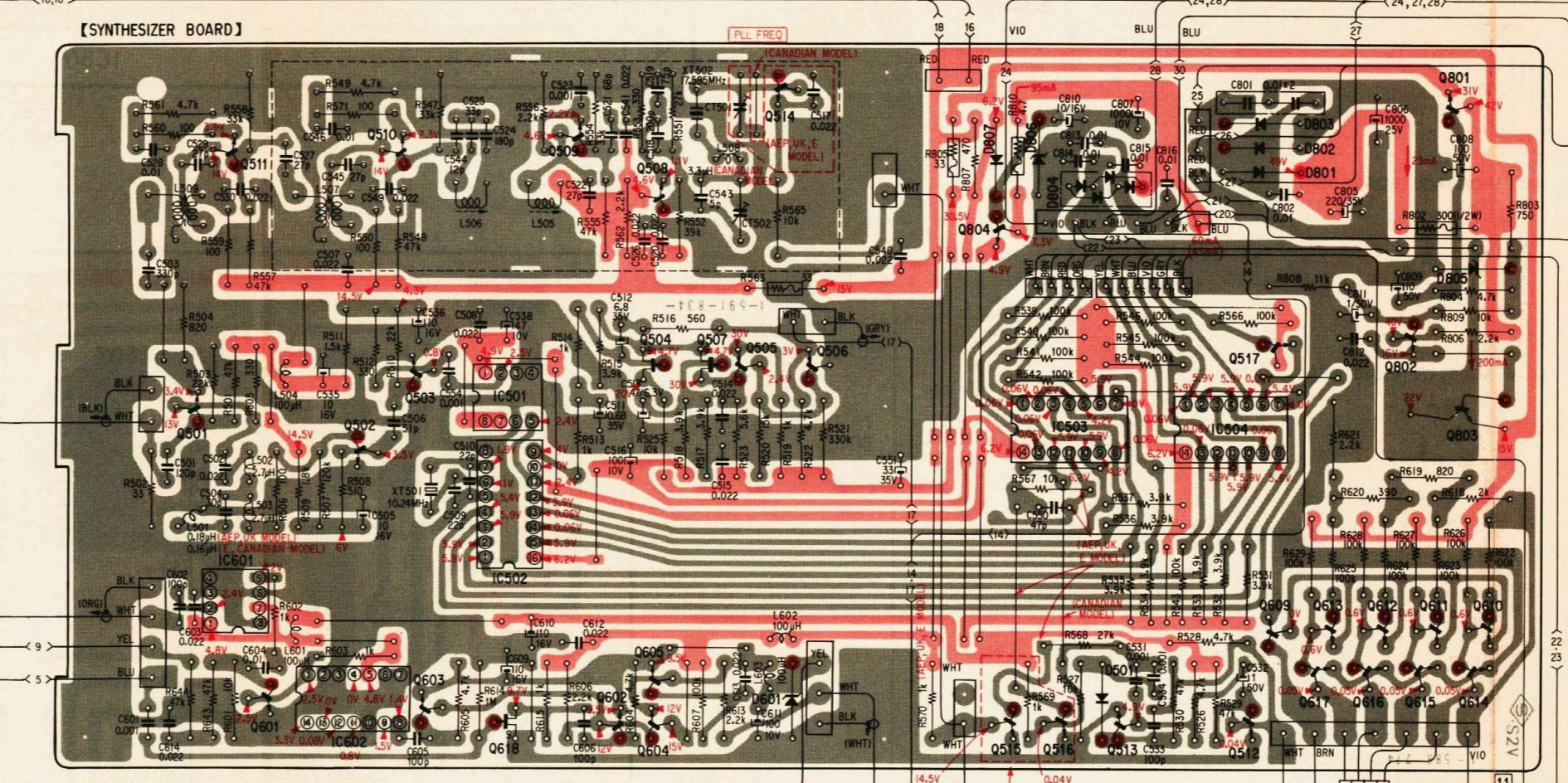

Note:  
 • Color code of sleeving over the end of the jacket.  
 • (WHT) (RED) (GRY)  
 • (RED)(GRY)  
 • indicates side identified with part number.  
 • part mounted on the conductor side.  
 • adjustment for repair.  
 • B+ pattern.

• Readings are taken under no signal (detuned) conditions with a VOM (20 kΩ/V) no mark : FM (38.5 MHz) ( ) : AM (530 kHz) ( ) : FM STEREO < > : PROGRAM SENSOR (ON)  
 • Signal Path  
 • : AM  
 • : FM  
 • : L-CH  
 • : R-CH



4.3. SCHEMATIC DIAGRAM

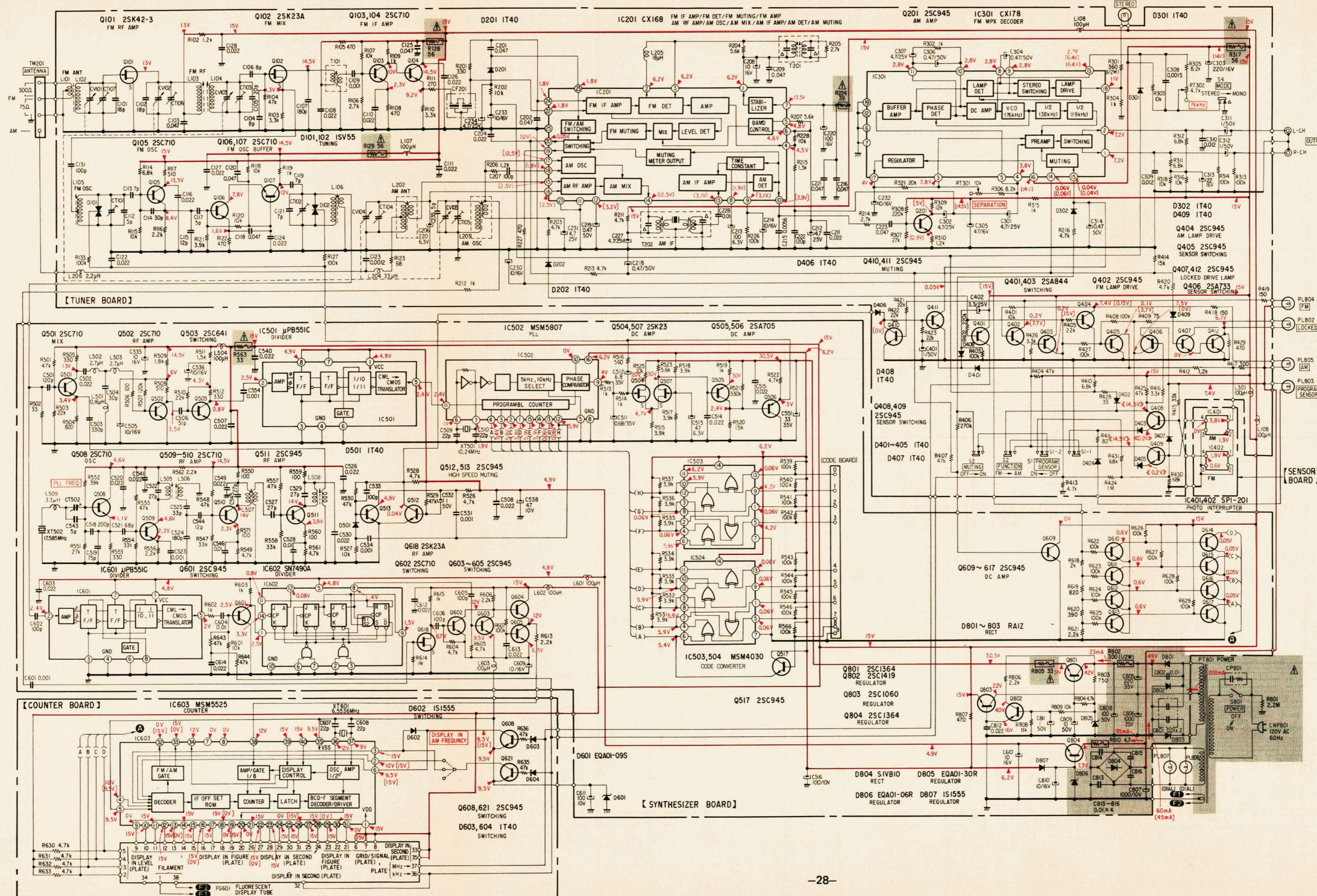

- Note:**
- Tuner reference numbers are not included in the Electrical Parts List.
  - All capacitors are in  $\mu\text{F}$  unless otherwise noted.  $\text{pF} = \mu\text{F} / 100$ .
  - All resistors are in ohms,  $\frac{1}{2}\text{W}$  unless otherwise noted.  $\text{k}\Omega = 1000\Omega$ ,  $\text{M}\Omega = 1000\text{k}\Omega$ .
  - All variable and adjustable resistors have characteristic curve B, unless otherwise noted.
  - $\square$ : fusible resistor.
  - $\Delta$ : internal component.
  - $\square$ : panel designation.
  - $\square$ : adjustment for repair.
  - $\square$ : B+ bus.
  - Readings are taken under no signal (detuned) conditions with a VOM (20 k $\Omega$ /V).
  - ( ) : FM (87.5 kHz)
  - ( ) : AM (530 kHz)
  - ( ) : FM STEREO
  - $\langle \rangle$  : PROGRAM SENSOR (ON)

Switch

Ref. No.	Switch	Position
S1	PROGRAM SENSOR	OFF
S2	FUNCTION	FM
S3	MUTING	OFF
S4	MODE	STEREO
S801	POWER	OFF

**Note:** The components identified by shading and mark  $\Delta$  are critical for safety. Replace only with part number specified.

**Note:** Les composants identifiés par un tramé et une marque  $\Delta$  sont critiques pour la sécurité. Ne les remplacer que par une pièce portant le numéro spécifié.



44. SCHEMATIC DIAGRAM

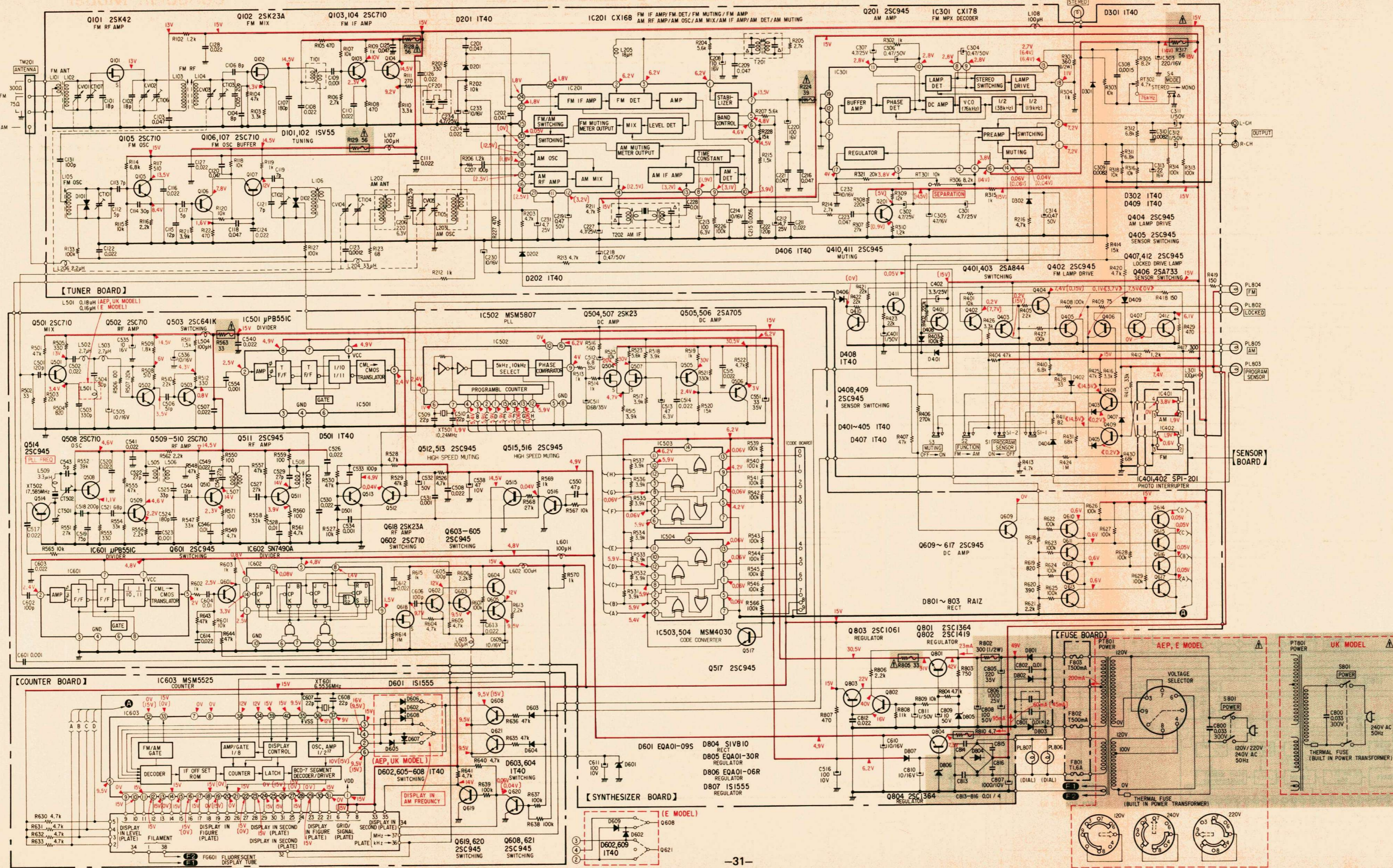



SECTION 5  
EXPLODED VIEWS

5.1.

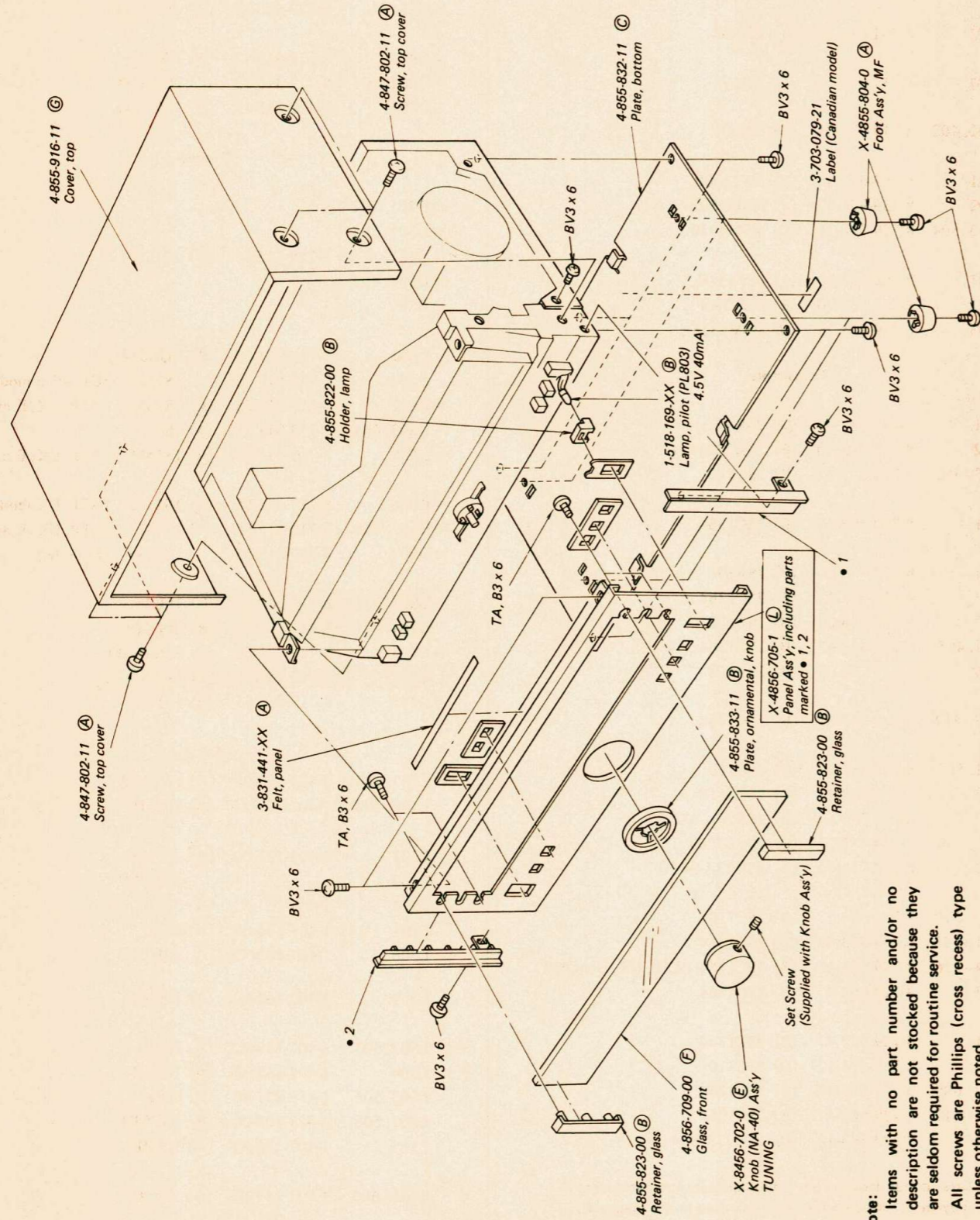

Note:

- Items with no part number and/or no description are not stocked because they are seldom required for routine service.
- All screws are Phillips (cross recess) type unless otherwise noted.
- Circled letters (A) to (Z) are applicable to European models only.

5.2.

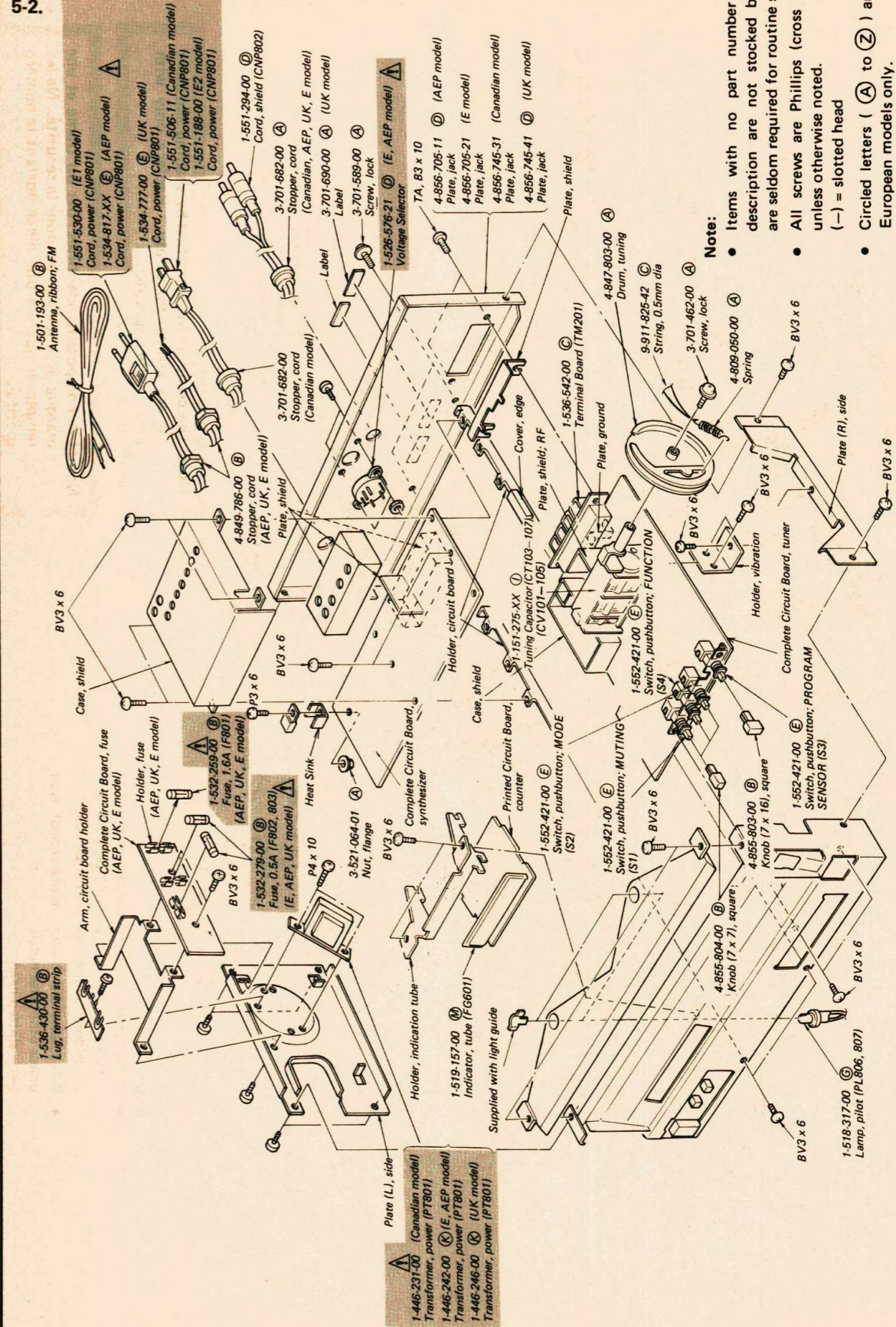

Note:

- Items with no part number and/or no description are not stocked because they are seldom required for routine service.
- All screws are Phillips (cross recess) type unless otherwise noted.
- Circled letters (A) to (Z) are applicable to European models only.

Note: The components identified by shading and mark **A** are critical for safety. Replace only with part number specified.

Note: Les composants identifiés par un trame et une marque **A** sont critiques pour la sécurité. Ne les remplacer que par une pièce portant le numéro spécifié.



SECTION 6  
ELECTRICAL PARTS LIST

Note:  
● Circled letters (A to Z) are applicable to European models only.

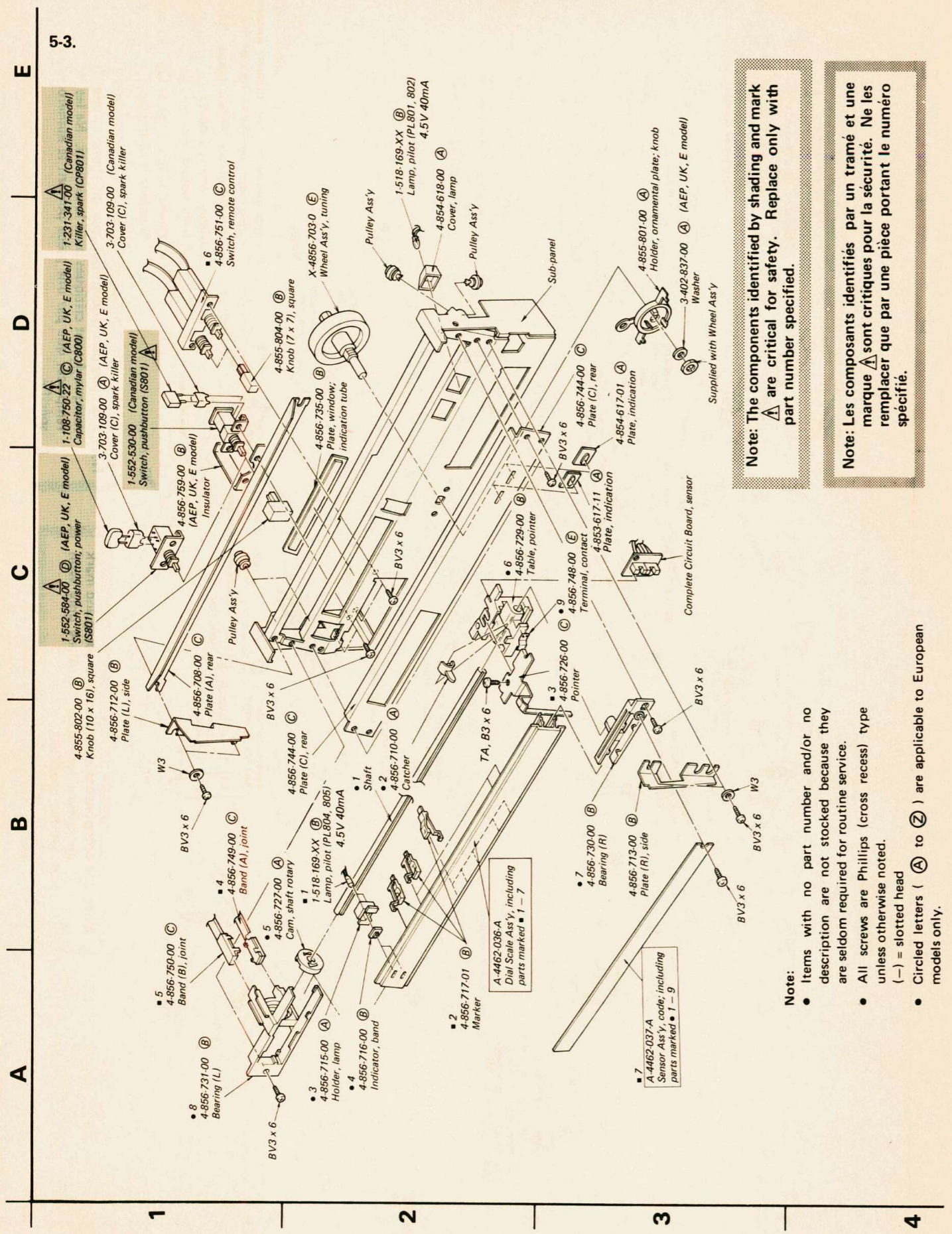

Note: The components identified by shading and mark **A** are critical for safety. Replace only with part number specified.

Note: Les composants identifiés par un trame et une marque **A** sont critiques pour la sécurité. Ne les remplacer que par une pièce portant le numéro spécifié.

- Note:
- Items with no part number and/or no description are not stocked because they are seldom required for routine service.
  - All screws are Phillips (cross recess) type unless otherwise noted.
  - Circled letters (A to Z) are applicable to European models only.

Ref. No.	Part No.	Description
<b>SEMICONDUCTORS</b>		
<b>ICs</b>		
IC201	8-751-680-01	(I) CX168
IC301	8-751-780-00	(G) CX178
IC401, 402	8-719-902-01	(D) SPI201
⇒ IC501	8-759-632-90	(E) M53290P
IC502	8-759-958-07	(J) MSM5807
IC503, 504	8-759-940-30	(C) MSM4030
IC601	8-759-155-10	(J) μPB551C
⇒ IC602	8-759-632-90	(E) M53290P
IC603	8-759-955-25	(M) MSM5525
<b>Transistors</b>		
Q101	8-727-313-00	(C) 2SK42-3
Q102	8-722-383-40	(B) 2SK23A-834
Q103-107	8-729-671-13	(B) 2SC710
⇒ Q201	8-729-663-47	(B) 2SC1364
⇒ Q401	8-727-788-00	(B) 2SA678
⇒ Q402	8-729-663-47	(B) 2SC1364
⇒ Q403	8-727-788-00	(B) 2SA678
⇒ Q404, 405	8-729-663-47	(B) 2SC1364
⇒ Q406	8-727-788-00	(B) 2SA678
⇒ Q407-412	8-729-663-47	(B) 2SC1364
Q501, 502	8-729-671-13	(B) 2SC710
Q503	8-729-364-12	(C) 2SC641K
⇒ Q504	8-722-394-60	(B) 2SK23A-940
⇒ Q505, 506	8-729-387-27	(B) 2SA872-D
⇒ Q507	8-722-394-60	(B) 2SK23A-940
Q508-510	8-729-671-13	(B) 2SC710
⇒ Q511-513	8-729-663-47	(B) 2SC1364
⇒ Q514-516	8-729-663-47	(B) 2SC1364 (AEP, UK, E model)
⇒ Q517	8-729-663-47	(B) 2SC1364
⇒ Q601	8-729-663-47	(B) 2SC1364
Q602	8-729-671-13	(B) 2SC710
⇒ Q603-605	8-729-663-47	(B) 2SC1364
⇒ Q608-617	8-729-663-47	(B) 2SC1364
Q618	8-722-383-40	(B) 2SK23A-834

⇒ Due to standardization, interchangeable replacements may be substituted for parts specified in the diagrams.

Note: The components identified by shading and mark **A** are critical for safety. Replace only with part number specified.

Ref. No.	Part No.	Description
⇒ Q619, 620	8-729-663-47	(B) 2SC1364 (AEP, UK, E model)
⇒ Q621	8-729-663-47	(B) 2SC1364
⇒ Q801	8-729-663-47	(B) 2SC1364
⇒ Q802, 804	8-729-316-12	(C) 2SC1061
Q803	8-729-316-12	(C) 2SC1061
<b>Diodes</b>		
⇒ D201, 202	8-719-815-55	(A) 1S1555
⇒ D301, 303		
⇒ D401-405		
⇒ D408, 409		
⇒ D501		
D601	8-719-931-09	(B) EQB01-09
D602	8-719-815-55	1S1555 (Canadian model)
⇒ D602	8-719-815-55	(A) 1S1555 (AEP, UK, E model)
⇒ D603, 604	8-719-815-55	(A) 1S1555
⇒ D605	8-719-815-55	(A) 1S1555 (AEP, UK, E model)
⇒ D606	8-719-815-55	(A) 1S1555 (AEP, UK model)
⇒ D607, 608	8-719-815-55	(A) 1S1555 (AEP, UK, E model)
⇒ D609	8-719-815-55	1S1555 (E model)
⇒ D801-803	8-719-200-02	(B) 10E2
D804	8-719-511-10	(B) SIVB10
⇒ D805	8-719-931-30	(B) EQB01-30
⇒ D806	8-719-931-06	(A) EQB01-06
D807	8-719-815-55	(A) 1S1555
<b>COILS</b>		
L103, 104	1-425-903-00	(B) FM RF2
L107, 108	1-407-169-XX	(A) 100μH
L202	1-401-731-00	(B) Antenna
L203		AM OSC
L204	1-407-163-XX	(A) 33μH
L205	1-407-741-00	(A) 18μH
L206	1-407-182-XX	(A) 2μH
L301	1-407-169-XX	(A) 100μH
L502, 503	1-407-183-XX	(A) 2.7μH
L504	1-407-169-XX	(A) 100μH
L505, 506	1-459-221-00	(B) Core
L507, 508	1-425-902-00	(B) FM RF1
L509	1-407-184-XX	(A) 3.3μH
L601-603	1-407-169-XX	(A) 100μH

Note: Les composants identifiés par un trame et une marque **A** sont critiques pour la sécurité. Ne les remplacer que par une pièce portant le numéro spécifié.



• Circled letters (A to Z) are applicable to European models only.

• Circled letters (A to Z) are applicable to European models only.

Ref. No.	Part No.	Description
<b>TRANSFORMERS &amp; FILTERS</b>		
CF201	1-527-277-11	(G) Filter, solid state 10.7MHz (AEP, Canadian, UK model)
	1-527-278-XX	Filter, solid state 10.7MHz (E model)
PT801	(A) 1-446-242-00	(K) Transformer, power (E, AEP model)
	(A) 1-446-246-00	(K) Transformer, power (UK model)
	(A) 1-446-231-00	Transformer, power (Canadian model)
T101	1-403-295-12	(B) IFT
T201	1-404-011-00	(C) Transformer, discric, FM
T202	1-404-086-00	IFT (E model)
	1-404-087-00	(C) IFT (AEP, Canadian, UK model)

**CAPACITORS**

All capacitors are in  $\mu$ F and ceramic unless otherwise noted. 50WV or less are not indicated except for electrolytics. pF :  $\mu$ F, elect : electrolytic

C101, 102	1-102-953-00	(A) 18p
C103	1-101-006-00	(A) 0.047
C104	1-102-945-00	(A) 8p
C105	1-102-958-00	(A) 20p
C106	1-102-945-00	(A) 8p
C107	1-102-848-00	(A) 180p
C108	1-101-005-00	(A) 0.022
C109	1-101-455-00	(A) 0.001
C110, 111	1-101-005-00	(A) 0.022
C112	1-102-856-00	(A) 5p
C113	1-102-662-00	(A) 7p
C114	1-102-673-00	(A) 30p
C115	1-102-666-00	(A) 12p
C116	1-101-005-00	(A) 0.022
C117	1-101-005-00	(A) 0.022 (AEP, UK, E model)
C117	1-102-856-00	(A) 5p
C118	1-101-006-00	(A) 0.047
C119	1-102-662-00	(A) 7p
C120	1-101-006-00	(A) 0.047
C121	1-102-662-00	(A) 7p

Note: The components identified by shading and mark (A) are critical for safety. Replace only with part number specified.

Ref. No.	Part No.	Description
C122	1-101-005-00	(A) 0.022
C123	1-102-118-00	(A) 0.0012
C124	1-101-005-00	(A) 0.022
C125	1-101-006-00	(A) 0.047
C126-128	1-101-005-00	(A) 0.022
C131	1-102-106-00	(A) 100p
C201, 202	1-101-006-00	(A) 0.047
C204	1-101-005-00	(A) 0.022
C206	1-121-419-00	(A) 220 6.3V elect
C207	1-102-975-00	(A) 100p
C208	1-121-651-00	(A) 10 16V elect
C209	1-101-006-00	(A) 0.047
C211	1-101-005-00	(A) 0.022
C212	1-121-395-00	(A) 4.7 25V elect
C213	1-121-414-00	(A) 100 6.3V elect
C214	1-121-651-00	(A) 10 16V elect
C215	1-108-355-00	(A) 0.0056 mylar
C216	1-101-006-00	(A) 0.047
C218, 219	1-121-726-00	(A) 0.47 50V elect
C220	1-121-415-00	(A) 100 16V elect
C221	1-101-006-21	(A) 0.047
C222	1-102-816-00	(A) 120p
C223	1-108-246-00	(A) 0.047 mylar
C227	1-121-395-11	(A) 4.7 25V elect
C228	1-101-004-21	(A) 0.01
C230	1-121-651-11	(A) 10 16V elect
C231	1-121-395-11	(A) 4.7 25V elect
C232, 233	1-121-651-11	(A) 10 16V elect
C234	1-121-395-11	(A) 4.7 25V elect
C235	1-102-998-11	(A) 5p
C301, 302	1-121-395-11	(A) 4.7 25V elect
C303	1-121-419-11	(A) 220 6.3V elect
C304	1-121-726-11	(A) 0.47 50V elect
C305	1-121-409-11	(A) 47 16V elect
C306	1-121-726-11	(A) 0.47 50V elect
C307	1-121-395-11	(A) 4.7 25V elect
C308	1-104-081-00	(A) 0.0015 styrol
C309, 310	1-101-004-21	(A) 0.01
C311, 312	1-121-391-11	(A) 1 50V elect
C313	1-121-479-11	(A) 22 16V elect

Note: Les composants identifiés par un tramé et une marque (A) sont critiques pour la sécurité. Ne les remplacer que par une pièce portant le numéro spécifié.

Ref. No.	Part No.	Description
C314	1-121-726-11	(A) 0.47 50V elect
C401	1-121-391-11	(A) 1 50V elect
C402	1-121-392-11	(A) 3.3 25V elect
C501	1-102-816-00	(A) 120p
C502	1-101-005-21	(A) 0.022
C503	1-102-820-00	(A) 330p
C504	1-102-962-00	(A) 30p
C505	1-121-651-11	(A) 10 16V elect
C506	1-101-882-00	(A) 51p
C507, 508	1-101-005-21	(A) 0.022
C509, 510	1-102-959-00	(A) 22p
C511	1-131-407-00	(B) 0.68 35V tantalum
C512	1-131-352-00	(B) 6.8 35V tantalum
C513	1-131-387-11	(B) 47 6.3V tantalum
C514, 515	1-101-005-21	(A) 0.022
C516	1-121-414-11	(A) 100 10V elect
C517	1-101-005-21	(A) 0.002
C518	1-102-977-00	(A) 200p
C519	1-101-890-21	(A) 75p
C520	1-101-005-21	(A) 0.022
C521	1-101-888-00	(A) 68p
C522	1-102-516-51	(A) 27p
C523	1-102-074-21	(A) 0.001
C524	1-102-976-00	(A) 180p
C525	1-102-518-51	(A) 33p
C526	1-101-005-21	(A) 0.022
C527	1-102-516-51	(A) 27p
C528	1-101-004-21	(A) 0.01
C529	1-102-516-51	(A) 27p
C530	1-101-005-00	(A) 0.022
C531	1-101-074-21	(A) 0.001
C532	1-121-391-11	(A) 1 50V elect
C533	1-102-975-00	(A) 100p
C534	1-102-074-21	(A) 0.001
C535, 536	1-121-651-00	(A) 10 16V elect
C538	1-121-352-11	(A) 47 10V elect
C540, 541	1-101-005-21	(A) 0.022
C543	1-102-942-21	(A) 5p
C544	1-102-510-51	(A) 12p

Note: The components identified by shading and mark (A) are critical for safety. Replace only with part number specified.

Ref. No.	Part No.	Description
C545	1-102-516-51	(A) 27p
C546	1-101-004-21	(A) 0.01
C549	1-101-005-21	(A) 0.022
C550	1-101-881-00	(A) 47p (AEP, UK, E model)
C551	1-121-652-11	(A) 33 35V elect
C554	1-102-074-21	(A) 0.001
C601	1-102-074-21	(A) 0.001
C602	1-102-975-00	(A) 100p
C603	1-101-005-21	(A) 0.022
C604	1-101-004-21	(A) 0.01
C605, 606	1-102-975-00	(A) 100p
C607, 608	1-102-959-00	(A) 22p
C609, 610	1-121-651-11	(A) 10 16V elect
C611	1-121-414-11	(A) 100 10V elect
C612-614	1-101-005-21	(A) 0.022
C800	(A) 1-108-750-22	(C) 0.033 300V mylar (E, AEP, UK model)
C801	(A) 1-102-355-00	(B) 0.01 x 2 500V
C802	(A) 1-101-004-21	(A) 0.01
C805	(A) 1-121-261-11	(B) 220 35V elect
C806	(A) 1-121-657-11	(B) 1000 25V elect
C807	(A) 1-121-736-11	(B) 1000 10V elect
C808	(A) 1-121-417-00	(B) 100 50V elect
C809	1-121-738-11	(A) 10 50V elect
C810	1-121-651-11	(A) 10 16V elect
C811	1-121-391-11	(A) 1 50V elect
C812	1-101-005-21	(A) 0.022
C813-816	(A) 1-101-004-21	(A) 0.01

CT101, 102	1-141-178-00	(B) Trimmer
CT501, 502	1-141-181-11	(B) Trimmer (AEP, UK, E model)
CV101-105	1-151-275-XX	(I) Tuning (Air) Capacitor
CT103-107		

**RESISTORS**

All resistors are in ohms. Common 1/4W carbon resistors are omitted. Refer to the list on the last page for their part numbers.

R128, 129	(A) 1-212-875-51	(A) 56 1/4W fuse (nonflammable)
-----------	------------------	---------------------------------

Note: Les composants identifiés par un tramé et une marque (A) sont critiques pour la sécurité. Ne les remplacer que par une pièce portant le numéro spécifié.



• Circled letters ( A to Z ) are applicable to European models only.

Ref. No.	Part No.	Description
R224	△ 1-217-394-00 (B) 39	¼W fuse (nonflammable)
R301	1-244-862-00 (A) 360	½W carbon
R317	△ 1-212-875-51 (A) 56	¼W fuse (nonflammable)
R563	△ 1-217-393-00 (B) 33	¼W fuse (nonflammable)
R801	△ 1-202-723-00 2.2M	½W composition (Canadian model)
R802	△ 1-212-993-51 (A) 300	½W fuse (nonflammable)
R805	△ 1-217-393-00 (B) 33	¼W fuse (nonflammable)
R810	△ 1-212-849-51 (A) 4.7	¼W fuse (nonflammable)

MISCELLANEOUS

CNP801	△ 1-534-817-XX (E)	Cord, power (AEP model)
	1-534-777-00 (E)	Cord, power (UK model)
	△ 1-551-188-00	Cord, power (E2 model)
	1-551-506-11	Cord, power (Canadian model)
	1-551-530-00	Cord, power (E1 model)
CNP802	1-551-294-00 (D)	Cord, shielded
CP801	△ 1-231-341-00	Killer, spark (Canadian model)
F801	△ 1-532-259-00 (B)	Fuse, 1.6A (E, AEP, UK model)
F802, 803	△ 1-532-279-00 (B)	Fuse, 0.5A (E, AEP, UK model)
FG601	1-519-157-00 (M)	Indicator, tube

PL801-805	1-518-169-XX (B)	Lamp, pilot; 4.5V 40mA; STEREO, LOCKED, PROGRAM-SENSOR, FM, AM
PL806, 807	1-518-317-00 (G)	Lamp, pilot; dial
S1-4	1-552-421-00 (E)	Switch, pushbutton
S801	△ 1-552-530-00	Switch, pushbutton; POWER (Canadian model)
	△ 1-552-584-00 (D)	Switch, pushbutton; POWER (AEP, UK, E model)

Ref. No.	Part No.	Description
TM201	1-536-542-00 (C)	Terminal Board
X501	1-527-293-21 (E)	Crystal
XT502	1-527-388-00 (D)	Crystal, osc
XT601	1-527-352-00 (D)	Crystal, osc
	1-508-754-00 (A)	Pin, MCD connector; 4p
	1-508-755-00 (B)	Pin, MCD connector; 6p
	△ 1-526-576-21 (D)	Voltage Selector (AEP, E model)
	1-536-354-00 (A)	Post Pin
	△ 1-536-430-00 (B)	Lug, terminal strip

ACCESSORIES & PACKING MATERIALS

Part No.	Description
1-501-184-00 (C)	Antenna, ribbon; FM
1-501-193-00 (B)	Antenna, AM
3-701-630-00 (A)	Bag, plastic
3-770-622-11 (C)	Manual, instruction (Canadian, UK model)
3-794-367-00 (A)	Manual, instruction
3-770-622-11 (C)	(AEP, E model)
4-855-829-00 (B)	Cushion
4-856-763-00 (D)	Carton

— Power Cord —

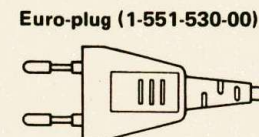

Parallel-blade plug (1-551-188-00)

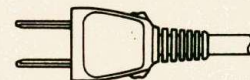

Note: The components identified by shading and mark △ are critical for safety. Replace only with part number specified.

Note: Les composants identifiés par un tramé et une marque △ sont critiques pour la sécurité. Ne les remplacer que par une pièce portant le numéro spécifié.

1/4 WATT CARBON RESISTORS (A)

Note: Circled letter (A) is applicable to European models only.

Ω	Part No.	Ω	Part No.	Ω	Part No.	Ω	Part No.	Ω	Part No.	Ω	Part No.	Ω	Part No.
1.0	1-246-401-00	10	1-246-425-00	100	1-246-449-00	1.0k	1-246-473-00	10k	1-246-497-00	100k	1-246-521-00	1.0M	1-246-545-00
1.1	1-246-402-00	11	1-246-426-00	110	1-246-450-00	1.1k	1-246-474-00	11k	1-246-498-00	110k	1-246-522-00	1.1M	1-210-814-00
1.2	1-246-403-00	12	1-246-427-00	120	1-246-451-00	1.2k	1-246-475-00	12k	1-246-499-00	120k	1-246-523-00	1.2M	1-210-815-00
1.3	1-246-404-00	13	1-246-428-00	130	1-246-452-00	1.3k	1-246-476-00	13k	1-246-500-00	130k	1-246-524-00	1.3M	1-210-816-00
1.5	1-246-405-00	15	1-246-429-00	150	1-246-453-00	1.5k	1-246-477-00	15k	1-246-501-00	150k	1-246-525-00	1.5M	1-210-817-00
1.6	1-246-406-00	16	1-246-430-00	160	1-246-454-00	1.6k	1-246-478-00	16k	1-246-502-00	160k	1-246-526-00	1.6M	1-210-818-00
1.8	1-246-407-00	18	1-246-431-00	180	1-246-455-00	1.8k	1-246-479-00	18k	1-246-503-00	180k	1-246-527-00	1.8M	1-210-819-00
2.0	1-246-408-00	20	1-246-432-00	200	1-246-456-00	2.0k	1-246-480-00	20k	1-246-504-00	200k	1-246-528-00	2.0M	1-210-820-00
2.2	1-246-409-00	22	1-246-433-00	220	1-246-457-00	2.2k	1-246-481-00	22k	1-246-505-00	220k	1-246-529-00	2.2M	1-210-821-00
2.4	1-246-410-00	24	1-246-434-00	240	1-246-458-00	2.4k	1-246-482-00	24k	1-246-506-00	240k	1-246-530-00	2.4M	1-244-754-00
2.7	1-246-411-00	27	1-246-435-00	270	1-246-459-00	2.7k	1-246-483-00	27k	1-246-507-00	270k	1-246-531-00	2.7M	1-244-755-00
3.0	1-246-412-00	30	1-246-436-00	300	1-246-460-00	3.0k	1-246-484-00	30k	1-246-508-00	300k	1-246-532-00	3.0M	1-244-756-00
3.3	1-246-413-00	33	1-246-437-00	330	1-246-461-00	3.3k	1-246-485-00	33k	1-246-509-00	330k	1-246-533-00	3.3M	1-244-757-00
3.6	1-246-414-00	36	1-246-438-00	360	1-246-462-00	3.6k	1-246-486-00	36k	1-246-510-00	360k	1-246-534-00	3.6M	1-244-758-00
3.9	1-246-415-00	39	1-246-439-00	390	1-246-463-00	3.9k	1-246-487-00	39k	1-246-511-00	390k	1-246-535-00	3.9M	1-244-759-00
4.3	1-246-416-00	43	1-246-440-00	430	1-246-464-00	4.3k	1-246-488-00	43k	1-246-512-00	430k	1-246-536-00	4.3M	1-244-760-00
4.7	1-246-417-00	47	1-246-441-00	470	1-246-465-00	4.7k	1-246-489-00	47k	1-246-513-00	470k	1-246-537-00	4.7M	1-244-761-00
5.1	1-246-418-00	51	1-246-442-00	510	1-246-466-00	5.1k	1-246-490-00	51k	1-246-514-00	510k	1-246-538-00	5.1M	1-244-762-00
5.6	1-246-419-00	56	1-246-443-00	560	1-246-467-00	5.6k	1-246-491-00	56k	1-246-515-00	560k	1-246-539-00		
6.2	1-246-420-00	62	1-246-444-00	620	1-246-468-00	6.2k	1-246-492-00	62k	1-246-516-00	620k	1-246-540-00		
6.8	1-246-421-00	68	1-246-445-00	680	1-246-469-00	6.8k	1-246-493-00	68k	1-246-517-00	680k	1-246-541-00		
7.5	1-246-422-00	75	1-246-446-00	750	1-246-470-00	7.5k	1-246-494-00	75k	1-246-518-00	750k	1-246-542-00		
8.2	1-246-423-00	82	1-246-447-00	820	1-246-471-00	8.2k	1-246-495-00	82k	1-246-519-00	820k	1-246-543-00		
9.1	1-246-424-00	91	1-246-448-00	910	1-246-472-00	9.1k	1-246-496-00	91k	1-246-520-00	910k	1-246-544-00		

HARDWARE NOMENCLATURE

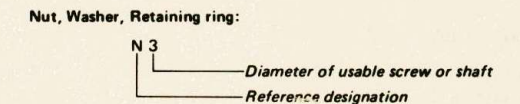
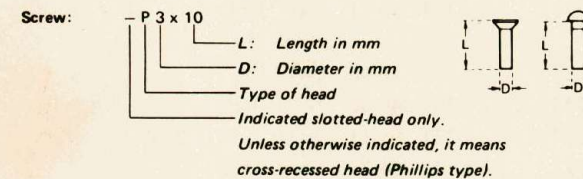

Reference Designation	Shape	Description	Remarks
<b>SCREWS</b>			
P		pan-head screw	binding-head (B) screw for replacement
PWH		pan-head screw with washer face	binding-head (B) screw and flat washer for replacement
PS PSP		pan-head screw with spring washer	binding-head (B) screw and spring washer for replacement
PSW PSPW		pan-head screw with spring and flat washers	binding-head (B) screw and spring and flat washers for replacement
R		round-head screw	binding-head (B) screw for replacement
K		flat-countersunk-head screw	
RK		oval-countersunk-head screw	
B		binding-head screw	
T		truss-head screw	binding-head (B) screw for replacement
F		flat-fillister-head screw	
RF		fillister-head screw	
BV		brazer-head screw	

Reference Designation	Shape	Description	Remarks
<b>SELF-TAPPING SCREWS</b>			
TA		self-tapping screw	ex: TA, P 3 x 10
PTP		pan-head self-tapping screw	binding-head self-tapping (TA, B) screw for replacement
PTPWH		pan-head self-tapping screw with washer face	binding-head self-tapping (TA, B) screw and flat washer for replacement
PTTWH		pan-head thread-rolling screw with washer face	binding-head (B) screw and flat washer for replacement
<b>SET SCREWS</b>			
SC		set screw	
SC		hexagon-socket set screw	ex: SC 2.6 x 4, hexagon socket
<b>NUT</b>			
N		nut	
<b>WASHERS</b>			
W		flat washer	
SW		spring washer	
LW		internal-tooth lock washer	ex: LW3, internal
LW		external-tooth lock washer	ex: LW3, external
<b>RETAINING RINGS</b>			
E		retaining ring	
G		grip-type retaining ring	

Sony Corporation