

SERVICE MANUAL

TU-X701

DIGITAL SYNTHESIZER TUNER

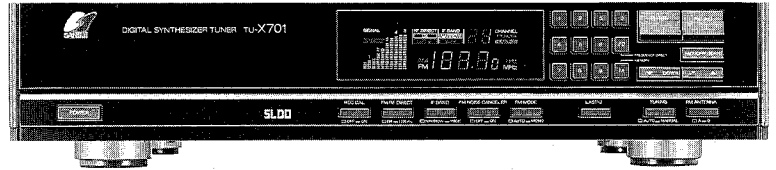

CAUTION

1. Parts identified by the \triangle symbol on the schematic diagram and the parts list are critical for safety. Use only replacement parts that have critical characteristics recommended by the manufacturer.
2. Make leakage-current or resistance measurements to determine that exposed parts are acceptably insulated from the supply circuit before returning the appliance to the customer.

•SPECIFICATIONS

FM Section

Tuning range.....	87.5 to 108 MHz
Usable sensitivity	
Mono IHF	10.8 dBf (0.95 μ V/75 Ω)
50 dB quieting sensitivity	
Mono	16.2 dBf
Stereo	37.0 dBf
Signal to noise ratio at 85 dBf	
Mono	98 dB
Stereo	91 dB
Distortion at 80 dBf (WIDE)	
Mono	less than 0.009% at 1,000 Hz
Stereo	less than 0.02% at 1,000 Hz
Alternate channel selectivity	
WIDE (at 400 kHz)	60 dB
NARROW (at 300 kHz)	75 dB
Stereo separation (WIDE)	60 dB at 1,000 Hz
Frequency response.....	20 to 15,000 Hz
	+0.5 dB, -0.5 dB
Antenna input impedance	
(A/B)	75 ohms unbalanced

AM Section

Tuning range.....	530 to 1,600 kHz
Usable sensitivity	48 dB/m (251 μ V/m)
Signal to noise ratio	50 dB (85 dB/m)
Image response ratio.....	45 dB at 1,000 kHz

Others

Output voltage and impedance	0.775 V
Power requirements	120/220/240V
	50/60 Hz
	For U.S.A. and Canada 120V (60 Hz)
Power consumption	14 Watts
Dimensions	448 mm (17-11/16")W
	98 mm (3-7/8")H
	315 mm (12-7/16")D
Weight	5.1 kg (11.2 lbs) net
	6.5 kg (14.3 lbs) packed

* Design and specifications subject to changes without notice for improvements.

* Due to local laws and regulations, this unit sold in some areas are not equipped with variable voltage selectors

NOTE

1. The symbols, UL, CSA, SA, BS, UK, EU, AS, SEV, SS and XX <EXPORT> on the parts list and the schematic diagram mean followings respectively.

- UL..... Manufactured for U.S.A market.
(Underwriters Laboratories approved model.)
- CSA Manufactured for Canadian market.
- SA..... Manufactured for South African market.
- BS, UK..... Manufactured for United Kingdom market.
- EU..... Manufactured for European market.
- AS..... Manufactured for Australian market.
- SEV..... Manufactured for Swiss market.
- SS..... Manufactured for Saudi Arabia market.
- XX <EXPORT> .. Standard Version.
- NON MARK..... Common Parts.

2. Some printed circuit boards are not supplied assembled. To separate these in this service manual, the stock numbers are not indicated for these boards. However, stock numbers for individual parts are indicated.

3. Since some capacitors and resistors are omitted from parts lists in this service manual, refer to the Common Parts List for capacitors and resistors, which was issued on June 1987.

4. Abbreviations in this service manual are as follows.

•Abbreviations List

- C.R. : Carbon Resistor
- S.R. : Solid Resistor
- Ce.R. : Cement Resistor
- M.R. : Metal Film Resistor
- F.R. : Fusing Resistor
- N.I.R. : Non-Inflammable Resistor
- A.R. : Array Resistor
- C.C. : Ceramic Capacitor
- C.T. : Ceramic Capacitor, Temperature Compensation
- E.C. : Electrolytic Capacitor
- E.L. : Low Leak Electrolytic Capacitor
- E.B. : Bi-Polar Electrolytic Capacitor
- E.B.L. : Low Leak Bi-Polar Electrolytic Capacitor
- Ta.C. : Tantalum Capacitor
- F.C. : Film Capacitor
- M.P. : Metalized Paper Capacitor
- P.C. : Polystyrene Capacitor
- G.C. : Gimmic Capacitor
- A.C. : Array Capacitor
- V.R. : Variable Resistor
- S.V.R. : Semi Variable Resistor
- SW. : Switch
- Chip R. : Chip Resistor
- Chip C. : Chip Capacitor

1. PACKING LIST

Parts No.	Stock No.	Description
1	27306700	Vyni Bag
2	27413700	Styrofoam Packing
3	27493600	Carton Case
4	27417500	Protector Sheet for Front Panel

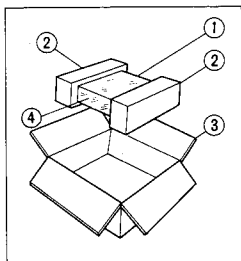

2. ACCESSORY LIST

Stock No.	Description
48730700	Antenna Plug (XX•UL•CSA•SS)
48489800	Antenna Plug (EU•SEV)
46051700	FM Antenna
07193400	PJP Cord
49028300	Operating Instruction (*E•F•S)
49028400	Operating Instruction (*G•I•Sw)

***Note**

- E•F•S:** English•French and Spanish Version
- G•I•Sw:** German•Italian and Swedish Version

3. BLOCK DIAGRAM

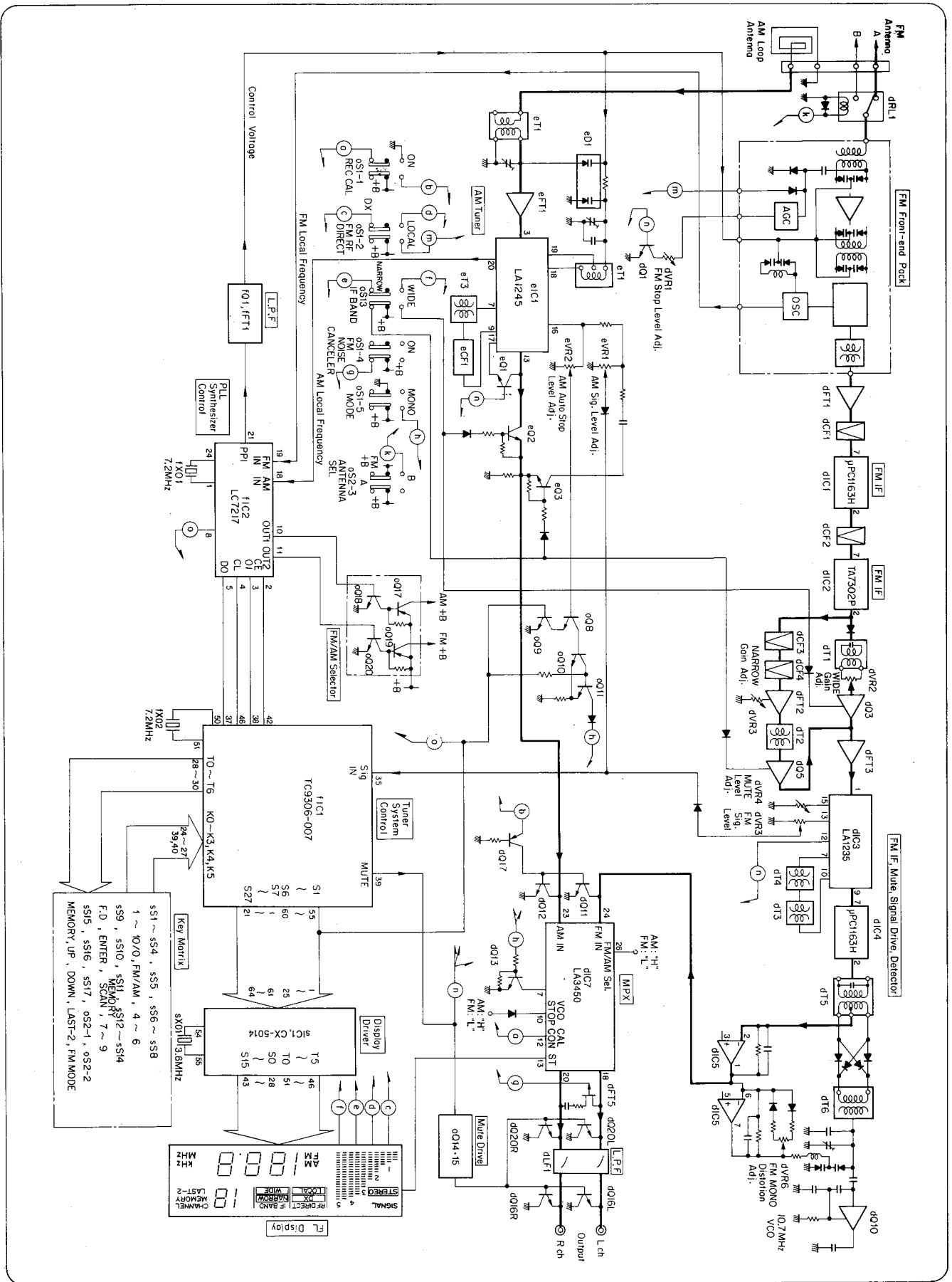

4. ADJUSTMENTS

4-1. FM Adjustment (See Top View on Page 11)

- Note: 1. FM/AM Switch..... FM
 2. FM RF DIRECT Switch DX
 3. Connect as shown Fig. 4-1.
 4. Set indication of reception frequency's display to 98MHz.

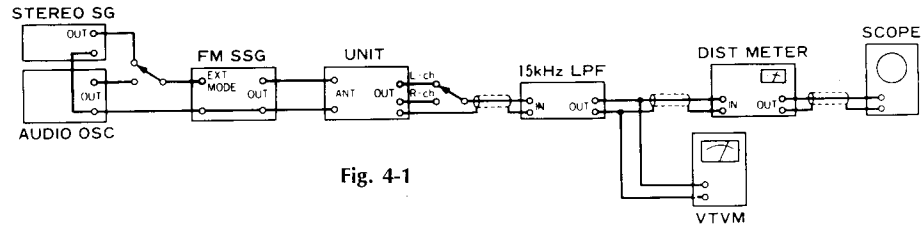
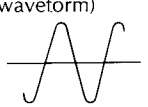
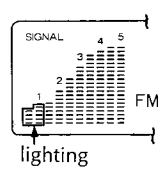

Fig. 4-1

1) FM IF, Detector, Rec Calibration Level Adjustment

- Note: 1. FM MODE Switch MONO
 2. IF BAND Switch WIDE (Except Step 3)

STEP	SUBJECT	FEED SIGNAL		MEASURE OUTPUT	ADJUST	ADJUST FOR	REMARKS
		FROM	TO				
1.	Reference Frequency Adj.	No Input	—	Between Point(A) (Pin 24 of fIC1, F-5728) and GND, Frequency Counter	dTC1 (F-5728)	7.200000MHz ±100Hz	
2.	Quadrature Offset Adj.	98MHz ANT Input, 65dBf (59.8dB), 1kHz (100% MOD.), FM SSG.	FM ANT Terminal	Between TP1 and TP2, F-5728, DC Volt Meter	dT4 (F-5728)	DC Volt 0V ±10mV	
3.	1) NARROW IF Adj. (IF BAND Switch..... NARROW)	98MHz ANT Input, 25~30dBf (19.8~24.8dB), 1kHz (100% MOD.), FM SSG.	FM ANT Terminal	Between Point(B) (JW22, Pin 13 of dIC3, F-5728) and GND, DC Volt Meter	dT2 (F-5728)	MAX DC Volt, Read the indication on DC Volt Meter	•Turn dVR3 and dVR2 of the F-5728 board fully clockwise.
	2) WIDE IF Adj. (IF BAND Switch..... WIDE)	98MHz ANT Input, 25~30dBf (19.8~24.8dB), 1kHz (100% MOD.), FM SSG.	FM ANT Terminal	Between Point(B) (JW22, Pin 13 of dIC3, F-5728) and GND, DC Volt Meter	dT1 (F-5728)	Equal DC Volts of wide band and narrow band.	
4.	FM Detector Adj.	1) No Input	—	Between TP3 and TP4, F-5728, DC Volt Meter	dT5, dTC1	DC Volt 0V	dTC1 for Fine Adjustment
		2) 98MHz ANT 20dBf (14.8dB), 1kHz (100% MOD.), FM SSG.	FM ANT Terminal	Output L ch or R ch, VTVM and Oscilloscope	dT6 (F-5728)	Max Output	(make symmetrical waveform) 
5.	Distortion Adj.	98MHz ANT Input, 65dBf (59.8dB), 1kHz (100% MOD.), FM SSG.	FM ANT Terminal	Output L ch or R ch, VTVM and Oscilloscope	dVR6 (F-5728)	Min. THD	
6.	Signal Indicator Level Adj.	98MHz ANT Input, 18dBf (12.8dB), 1kHz (100% MOD.), FM SSG.	FM ANT Terminal	Signal Indicator (Display)	dVR5 (F-5728)	Make only one signal indicator lighting.	
7.	REC CAL (Rec Calibration) Level Adj.	1) 98MHz ANT Input, 65dBf (59.8dB), 1kHz (100% MOD.), FM SSG.	FM ANT Terminal	Output L ch or R ch, VTVM and Oscilloscope	—	Read the indication on VTVM	•REC CAL Switch..... OFF
		2) —	—	Output L ch or R ch, VTVM and Oscilloscope	dVR9 (F-5728)	-6dB from the above reading.	•REC CAL Switch..... ON

2) FM Stereo Adjustment

Note: 1. FM MODE Switch AUTO
2. FM NOISE CANCELER Switch OFF
3. Set indication of reception frequency's display to 98MHz.

STEP	SUBJECT	FEED SIGNAL		MEASURE OUTPUT	ADJUST	ADJUST FOR	REMARKS
		FROM	TO				
1.	Pilot Signal Cancelling Adj.	98MHz ANT Input, 65dB (59.8dB), FM SSG, Pilot 19kHz (9% MOD.), STEREO SG.	FM ANT Terminal	Between PointⒸ (dR7L or R) and GND Oscilloscope through 19kHz band pass filter (B.P.F.)	dT8, dVR10 (F-5728)	1) Confirm that 19kHz pilot signal indicated on oscilloscope. 2) Min. 19kHz pilot signal level.	•Adjust dT8 and dVR10 alternately.
2.	WIDE Separation Adj. (IF BAND Switch, ...WIDE)	1) 98MHz ANT Input, 65dB (59.8dB), FM SSG, Pilot 19kHz (9% MOD.), L Mode 1kHz + Pilot (100% MOD.), STEREO SG.	FM ANT Terminal	Output L ch, VTVM and Oscilloscope	dVR7L (F-5728)	—40dB from the indication above.	•Repeat procedures as stated in subject 1) and 2).
		2) 98MHz ANT Input, 65dB (59.8dB), FM SSG, Pilot 19kHz (9% MOD.), R Mode 1kHz + Pilot (100% MOD.), STEREO SG.	FM ANT Terminal	Output R ch, VTVM and Oscilloscope	dVR7R (F-5728)	—40dB from the indication above.	
3.	NARROW Separation Adj. (IF BAND Switch, ...NARROW)	98MHz ANT Input, 65dB (59.8dB), FM SSG, Pilot 19kHz (9% MOD.), L Mode 1kHz + Pilot (100% MOD.), STEREO SG.	FM ANT Terminal	Output L ch, VTVM and Oscilloscope	dVR8 (F-5728)	—30dB from the indication above.	•Confirm R→L ch
			FM ANT Terminal	Output R ch, VTVM and Oscilloscope	dVR8 (F-5728)	—30dB from the indication above.	
4.	Auto Stop Level Adj.	98MHz ANT Input, 35dB (29.8dB), FM SSG, Pilot 19kHz (9% MOD.), STEREO Mode 1kHz + Pilot (100% MOD.), STEREO SG.	FM ANT Terminal	Reception Frequency (Display)	dVR1 (F-5728)	Tune the tuner to 98MHz by using the automatic search tuning operation.	
5.	Muting Level Adj.	98MHz ANT Input, 22dB (16.8dB), FM SSG, Pilot 19kHz (9% MOD.), L or R Mode 1kHz + Pilot (100% MOD.), STEREO SG.	FM ANT Terminal	Stereo indicator (Display) and Output L or R ch, VTVM & Oscilloscope	dVR4 (F-5728)	Stereo Indicator turns on and Output Signal comes out.	

◆ADJUSTMENT FOR FM

There are two kind in indication of FM SSG output attenuator.
1. Attenuator with marking of 75Ω open open indication type.
2. Attenuator with marking of 75Ω load or close load or close indication type.
FM SSG output level in this FM adjustment are described as open indication type.
To feed FM signal, a dummy antenna circuit as Fig. 2-3 must be connected between FM SG output and ANT terminal (300Ω) of the unit.

• The following table shows relations among FM SG attenuator indication (dB), available power ratio (dB) and antenna terminal voltage (dBμV) in each indication type.

	FM SG Attenuator Indication	Available Power Ratio	Antenna Terminal Voltage
Open indication type	0 dB 66 dB	-0.8 dBf 65.2 dBf	-6 dBμV 60 dBμV
Load or close indication type	0 dB 60 dB	5.2 dBf 65.2 dBf	0 dBμV 60 dBμV

Fig. 4-2

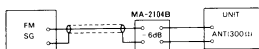

4-2. AM Adjustment (See Top View on Page 11)

Note: 1. FM/AM Switch AM
2. IF BAND Switch NARROW
3. Connect Loop Antenna to antenna terminal.
4. REC CAL Switch OFF
5. Connect as shown Fig. 4-3.

Fig. 4-3

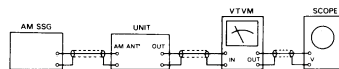
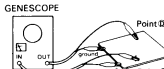

Fig. 4-4



STEP	SUBJECT	FEED SIGNAL		MEASURE OUTPUT	ADJUST	ADJUST FOR	REMARKS
		FROM	TO				
1.	IF Coil Adj. (Using Genescope)	Output 60dB, Genescope	Between PointⒸ (eK17, F-5728) and GND	Between PointⒸ (eK17, F-5728) and GND	eT3 (F-5728)	Max waveform	
2.	531kHz (or 530kHz) Tuning Adj.	No Input	—	Reception Frequency (Display)	Manual Tuning, UP/DOWN Switch	531kHz (or 530kHz)	•Repeat procedures as stated in subject 2 and 3.
				Between PointⒸ (eT1, F-5728) and GND, DC Volt Meter	eT1 (F-5728)	1.5V ± 10mV	
3.	1602kHz (or 1610kHz) Tuning Adj.	No Input	—	Reception Frequency (Display)	Manual Tuning, UP/DOWN Switch	1602kHz (or 1610kHz)	
				Between PointⒸ (eT1, F-5728) and GND, DC Volt Meter	eT1 (F-5728)	20V ± 10mV	
4.	603kHz (or 600kHz) RF Adj.	603kHz (or 600kHz) ANT Input, 30dB, 400Hz (30% MOD.), AM SSG.	AM ANT Terminal	Reception Frequency (Display)	Manual Tuning, UP/DOWN Switch	603kHz (or 600kHz)	•Repeat procedures as stated in subject 4 and 5.
				Output L or R ch, VTVM & Oscilloscope	eT3 (F-5728)	Max output	
5.	1404kHz (or 1400kHz) RF Adj.	1404kHz (or 1400kHz) ANT Input, 30dB, 400Hz (30% MOD.), AM SSG.	AM ANT Terminal	Reception Frequency (Display)	Manual Tuning, UP/DOWN Switch	1404kHz (or 1400kHz)	
				Output L or R ch, VTVM & Oscilloscope	eTC2 (F-5728)	Max output	
6.	Signal Indicator Level Adj.	999 kHz (or 1000kHz) ANT Input, 60dB, 400Hz (30% MOD.), AM SSG.	AM ANT Terminal	Signal Indicator (Display)	eVR1 (F-5728)	Make 5 signal indicators lighting.	
7.	Auto Stop Level Adj.	999 kHz (or 1000kHz) ANT Input, 55dB, 400Hz (30% MOD.), AM SSG.	AM ANT Terminal	Reception Frequency (Display)	eVR2 (F-5728)	Tune the tuner to 999kHz (or 1000kHz) by using the automatic search tuning operation.	

TU-X701 TU-X701

ON BOARD

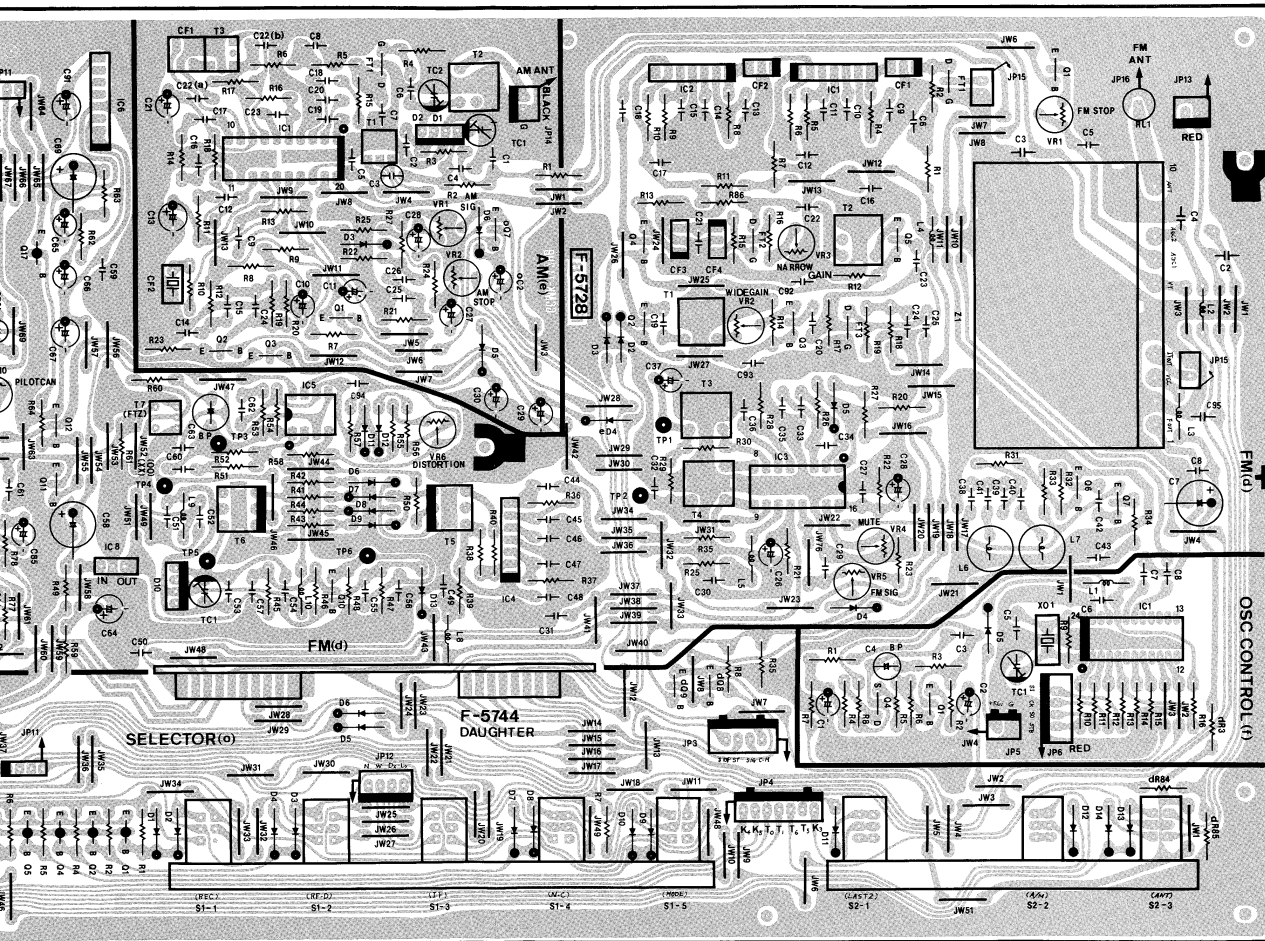

5-2.F-5729 Control and Display Board
Component Side

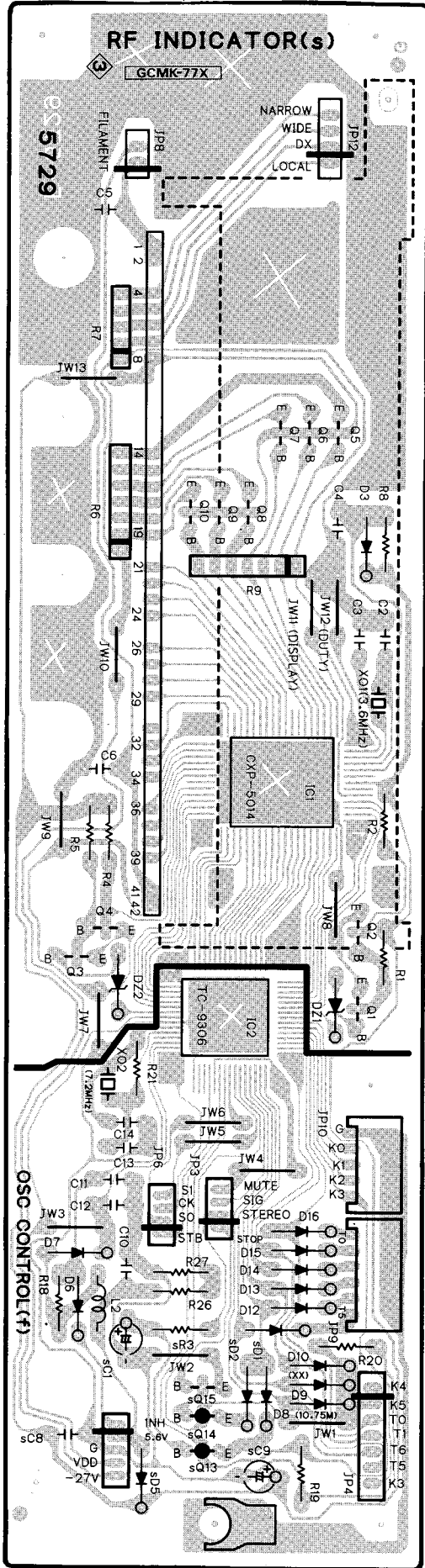

5-3.F-5730 Operation Switch Board
Component Side

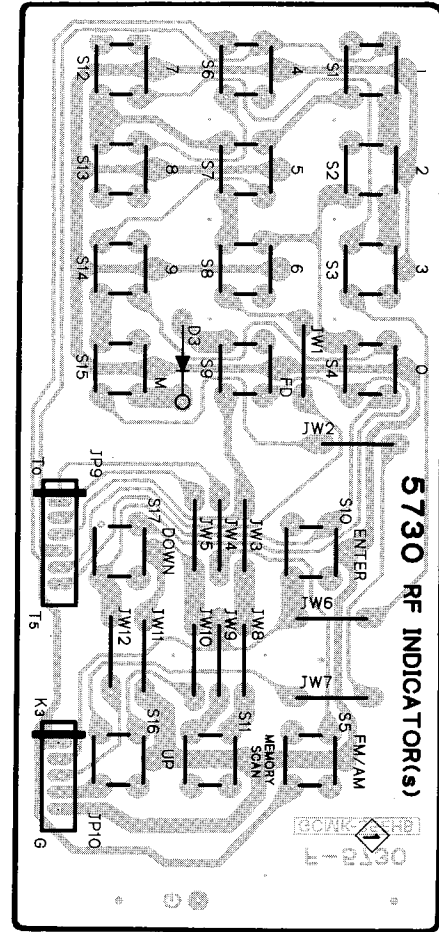

5-4.F-5732 Power Switch Board
Component Side

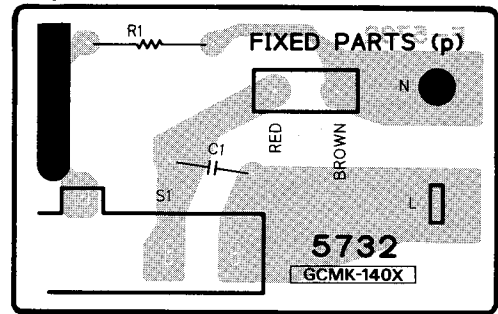

5-5.F-5733 OUTPUT Terminal Board
Component Side

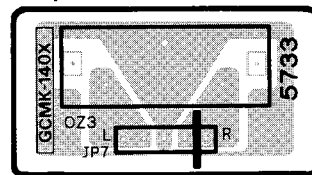

5-6.F-5731 Power Supply Board

Component Side

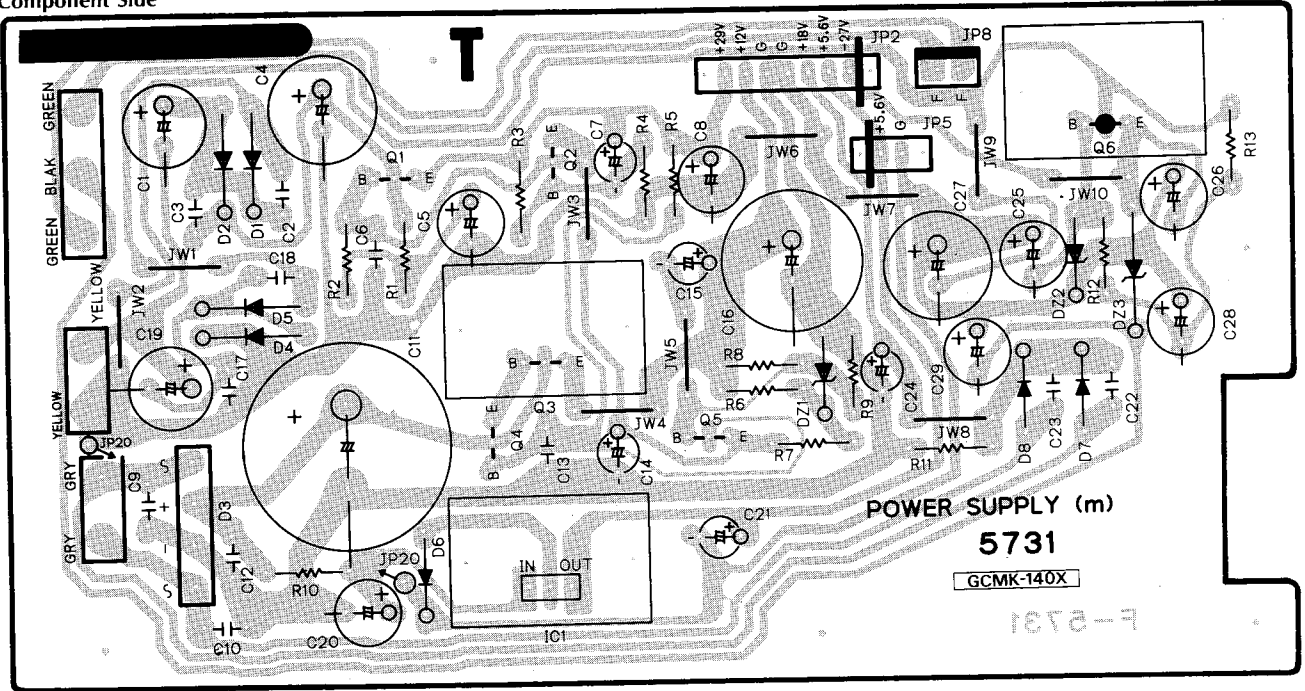

5-7.F-5744 FM/AM Band Selector Board

Component Side

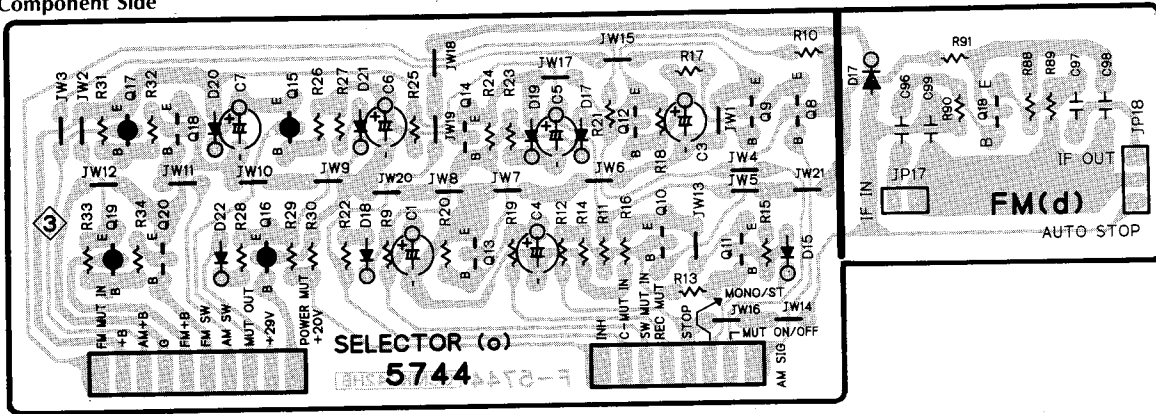

5-8.F-5810 FM/AM Antenna Terminal Board

Component Side

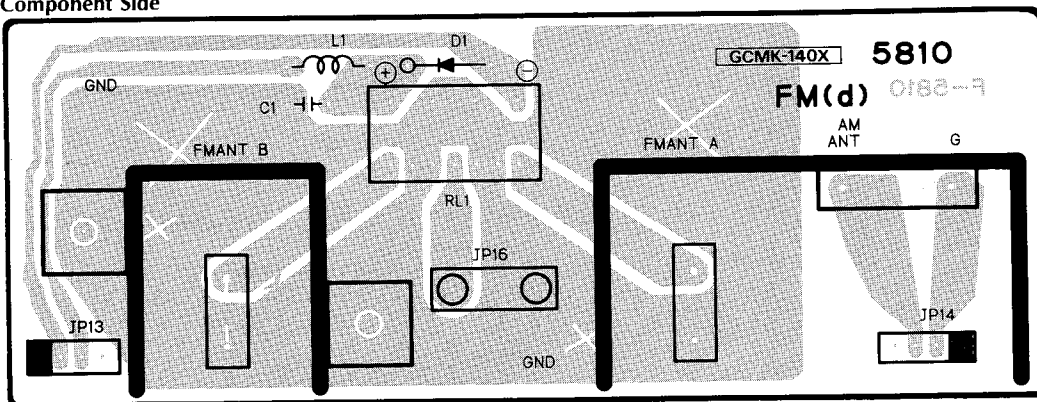

6. PARTS LIST OF BOARD

6-1. F-5728 Main Board <Stock No. 01042601 = XX•SS•UL•CSA/01042605 = EU•SEV>

Parts No.	Stock No.	Description	Parts No.	Stock No.	Description
dZ1	48843000	FM Frontend Pack	dL5	48071100	Inductor
•Transistor			dL6, 7	46091100	Inductor 8.2mH
dQ1	48223100	DTC114TS	dL8	48071300	Inductor
dQ3	48223100	DTC114TS	dL9, 10	48070700	Inductor
dQ5	48223100	DTC114TS	dT1	48839200	FM IF Coil
dQ6	46393201	2SC2786	dT2	48865300	FM IF Coil
dQ7	46719800	DTA124ES	dT3	48839300	FM IF Coil
dQ8	46367101	2SC2603	dT4	48845110	FM IF Coil
	or 46367301	2SC2458	dT5	48839400	FM IF Coil
	or 46391901	2SC2785	dT6	48839500	FM IF Coil
dQ9	48230200	DTC124XS	dT8	42407200	FM MPX Coil
dQ10	46367101	2SC2603	dVR1	46634700	47kΩ S.V.R., FM auto stop level adj.
dQ11	48230400	DTC143TS	dVR2	46633700	1kΩ (B) S.V.R., wide gain adj.
dQ12	48230400	DTC143TS	dVR3	46633700	1kΩ (B) S.V.R., narrow gain adj.
dQ13	48171600	DTC114YS	dVR4	46634700	47kΩ S.V.R., muting level adj.
dQ16	46604301	2SC3327	dVR5	46634700	47kΩ S.V.R., FM sig. level adj.
dQ17	48229400	DTA114TS	dVR6	46634900	100kΩ S.V.R., FM mono dist. adj.
dQ19	48229200	DTA124XS	dVR7	46635500	1MΩ S.V.R., FM wide sepa. adj.
dQ20	48230400	DTC143TS (XX•EU•SEV•SS)	dVR8	46635500	1MΩ S.V.R., FM narrow sepa. adj.
•FET			dVR9	46634700	47kΩ S.V.R., rec cal. level adj.
dFT1 ~ 3	46724700	2SK241-Y	dVR10	46634700	47kΩ S.V.R., FM pilot cancel adj.
	or 46724701	2SK241-GR	dS1	07251100	Slide SW., 50μS/75μS (XX•SS)
dFT4	46643501	2SK163-K2	•Transistor		
	or 46643601	2SK117-Y	eQ1	48223100	DTC114TS
dFT5	46643800	2SJ103-Y (XX•EU•SEV•SS)	eQ2, 3	48230200	DTC124XS
	or 46643801	2SJ103-GR (XX•EU•SEV•SS)	•FET		
•IC			eFT1	46393000	2SK192A-Y
dIC1	03605400	μPC1163H		or 46393001	2SK192A-GR
dIC2	03605900	TA7302P	•IC		
dIC3	48347500	LA1235	eIC1	07237200	LA1245
dIC4	03605400	μPC1163H	•Diode		
dIC5	46151400	NJM2043D-D	eD1	07237300	kV1226-EF (Variable Capacitance)
dIC7	48840400	LA3450	eD4 ~ 6	03117600	1S2473T77
dXO1	48128400	Ceramic OSC Element KBR-457HS		or 46086000	1S1588TP-3
	or 48272800	Ceramic OSC Element CSB456	eC15	48103400	1μF 50V E.B.
•Diode			eTC1, 2	46095600	Trimmer Capacitor 20pF
dD2 ~ 5	03117600	1S2473T77	eCF1	48845600	Ceramic Filter SFP450G
	or 46086000	1S1588TP-3	eCF2	46578100	Ceramic Filter BFU450C10N
dD6 ~ 9	48836700	1SS176	eT1	46724100	AM OSC Coil
dD10	07197200	KV1226 (Variable Capacitance)	eT2	46724200	AM ANT Coil
dD11, 12	46421300	1N60PSP	eT3	46724300	AM IF Coil
dD13 ~ 16	03117600	1S2473T77	eVR1	46634700	47kΩ S.V.R., AM sig. level adj.
	or 46086000	1S1588TP-3	eVR2	46634700	47kΩ S.V.R., AM auto stop level adj.
dD18, 19	03117600	1S2473T77 (XX•EU•SEV•SS)	•Transistor		
	or 46086000	1S1588TP-3 (XX•EU•SEV•SS)	fQ1	46367101	2SC2603
dD20	48867300	MI204 (XX•EU•SEV•SS)	•FET		
	or 48948600	1SV99 (XX•EU•SEV•SS)	fFT1	46643501	2SK163-K2
dD21, 22	03117600	1S2473T77 (XX•EU•SEV•SS)		or 46643601	2SK117-Y
	or 46086000	1S1588TP-3 (XX•EU•SEV•SS)	•IC		
ΔdR3	46228200	22Ω 1/2W N.I.R	fic1	48840300	LC7217
•Zener Diode			fXO1	07237700	Quartz Crystal NR-18
dDZ1	46112700	05Z8.2-Y			
dTC1	46444400	Trimmer Capacitor 10pF			
dCF1, 2	46920000	Ceramic Filter SFE10.7MX			
dCF3, 4	46202500	Ceramic Filter SFE10.7MS2			
dLF1	46894900	Low Pass Filter TF-10			
dL2	48070700	Inductor			
dL3, 4	48071300	Inductor			

to be continued ►

< F-5728 >

Parts No.	Stock No.	Description
•Diode		
fD1	03117600 or 46086000	1S2473T77 (XX·UL·CSA·SS) 1S1588TP-3 (XX·UL·CSA·SS)
fD2	03117600 or 46086000	1S2473T77 (XX·EU·SEV·SS) 1S1588TP-3 (XX·EU·SEV·SS)
fD3	03117600 or 46086000	1S2473T77 (XX·UL·CSA·SS) 1S1588TP-3 (XX·UL·CSA·SS)
fD4	03117600 or 46086000	1S2473T77 (XX·EU·SEV·SS) 1S1588TP-3 (XX·EU·SEV·SS)
fD5	03117600 or 46086000	1S2473T77 1S1588TP-3
fc4	48103400	1μF 50V E.B.
fc9	48798900	0.039μF 5.5V E.C., back up
fTC1	46095800 or 46163000	Trimmer Capacitor 45pF Trimmer Capacitor 50pF
fL1	48070700	Inductor
fS1	46177200	Slide SW., 9k/10kHz (XX)
•Transistor		
oQ1 ~ 6	46367201 or 46392001	2SA1048 2SA1175
oQ7	48171600	DTC114YS
•Diode		
oD1 ~ 14	03117600	1S2473T77
oD16	03117600 or 46086000	1S2473T77 1S1588TP-3
oD23	03117600 or 46086000	1S2473T77 (XX·EU·SEV·SS) 1S1588TP-3 (XX·EU·SEV·SS)
oS1	48839100	Push SW. (5-key), REC CAL·RF DIRECT·IF BAND·FM NOISE CANCELER·FM MODE
oS2	48839000	Push SW. (3-key), LST-2·TUNING·ANTENNA

6-2. F-5729 Control and Display Board
(Stock No. 01042701)

Parts No.	Stock No.	Description
•IC		
fIC2	48840200	TC9306-007
fX02	48905800	Quartz Element
•Diode		
fD6, 7	03117600 or 46086000	1S2473T77 1S1588TP-3
fD9	03117600 or 46086000	1S2473T77 1S1588TP-3
fD11 ~ 16	03117600 or 46086000	1S2473T77 1S1588TP-3
fL2	48070700	Inductor
•Transistor		
sQ1 ~ 4	48217800	DTC114ES
sQ5 ~ 10	48230400	DTC143TS
sQ13, 14	48229400	DTA114TS
sQ15	48171600	DTC114YS
•IC		
sIC1	48904000	CXP5014
sX01	48343900	Ceramic OSC Element CSA3.60

< F-5729 >

Parts No.	Stock No.	Description
•Diode		
sD1, 2	03117600 or 46086000	1S2473T77 1S1588TP-3
sD5	03117600 or 46086000	1S2473T77 1S1588TP-3
•Zener Diode		
sDZ1, 2	46823200	RD3.0E-B1
sFL1	48903800	FL. Display Tube FV171G
sR6	46346800	100kΩX6 1/8W A.R.
sR7	46343100	100kΩX4 1/8W A.R.

6-3. F-5730 Operation Switch Board

Parts No.	Stock No.	Description
•Diode		
sD3	03117600 or 46086000	1S2473T77 1S1588TP-3
sS1	48592000	Push SW., 1 (preset)
sS2	48592000	Push SW., 2 (preset)
sS3	48592000	Push SW., 3 (preset)
sS4	48592000	Push SW., 0 (preset)
sS5	48592000	Push SW., FM/AM
sS6	48592000	Push SW., 4 (preset)
sS7	48592000	Push SW., 5 (preset)
sS8	48592000	Push SW., 6 (preset)
sS9	48592000	Push SW., F.D
sS10	48592000	Push SW., ENTER
sS11	48592000	Push SW., MEMORY SCAN
sS12	48592000	Push SW., 7 (preset)
sS13	48592000	Push SW., 8 (preset)
sS14	48592000	Push SW., 9 (preset)
sS15	48592000	Push SW., MEMORY
sS16	48592000	Push SW., UP
sS17	48592000	Push SW., DOWN

6-4. F-5731 Power Supply Board <Stock No. 01042901>

Parts No.	Stock No.	Description
•Transistor		
ΔmQ1	48581701	2SD438
ΔmQ2	46367101 or 46367301	2SC2603 2SC2458
Δ	46391901	2SC2785
ΔmQ3	46546701	2SD880
ΔmQ4	46367101 or 46367301	2SC2603 2SC2458
Δ	46391901	2SC2785
ΔmQ5	46367101 or 46367301	2SC2603 2SC2458
Δ	46391901	2SC2785
ΔmQ6	03032301	2SB507V11AL
•IC		
ΔmIC1	48599500	AN78N05
•Diode		
ΔmD1	03117700	10E2
ΔmD2	03117700	10E2
ΔmD3	03117000	RB152
ΔmD4	03117700	10E-2
ΔmD5	03117700	10E-2
ΔmD6	03117600 or 46086000	1S2473T77 1S1588TP-3
ΔmD7	03117600 or 46086000	1S2473T77 1S1588TP-3
ΔmD8	03117600 or 46086000	1S2473T77 1S1588TP-3

<F-5731>

Parts No.	Stock No.	Description
•Zener Diode		
mDZ1	46112700	05Z8.2-Y
mDZ2	46115700	05Z22-Y
mDZ3	03168500	RD5.1F
△mR10	46228400	33Ω 1/2W N.I.R

6-5. F-5732 POWER Switch Board

Parts No.	Stock No.	Description
△pC1	46425800	0.01μF 400V C.C.
△pS1	46360300	Push SW., POWER (XX•EU•SEV•SS)
△	48846300	Push SW., POWER (UL•CSA)

6-6. F-5733 OUTPUT Terminal Board

Parts No.	Stock No.	Description
	48948500	2P Terminal Board

6-7. F-5744 FM/AM Band Selector Board

Parts No.	Stock No.	Description
•Transistor		
dQ18	46393201	2SC2786 (XX•EU•SEV•SS)
•Diode		
dD17	46464100	1SS133 (XX•EU•SEV•SS)
•Transistor		
oQ8	48223100	DTC114TS
oQ9	46834300	DTC144ES
oQ10 ~ 14	46367101	2SC2603
	or 46367301	2SC2458
	or 46391901	2SC2785
oQ15	46367201	2SA1048
	or 46392001	2SA1175
oQ16	46719800	DTA124ES
oQ17	46367201	2SA1048
	or 46392001	2SA1175
oQ18	48171600	DTC114YS
oQ19	48000801	2SA934
oQ20	48171600	DTC114YS
•Diode		
oD15	46464100	1SS133
oD17 ~ 22	46464100	1SS133

6-8. F-5810 FM/AM Antenna Terminal Board

Parts No.	Stock No.	Description
•Diode		
dD1	03117600	1S2473T77 (XX•EU•SEV•SS)
	or 46086000	1S1588TP-3 (XX•EU•SEV•SS)
dL1	48070700	Inductor (XX•EU•SEV•SS)
dRL1	48943400	Relay
oZ1	48913900	Antenna Terminal

7. OTHER PARTS

7-1. Front View

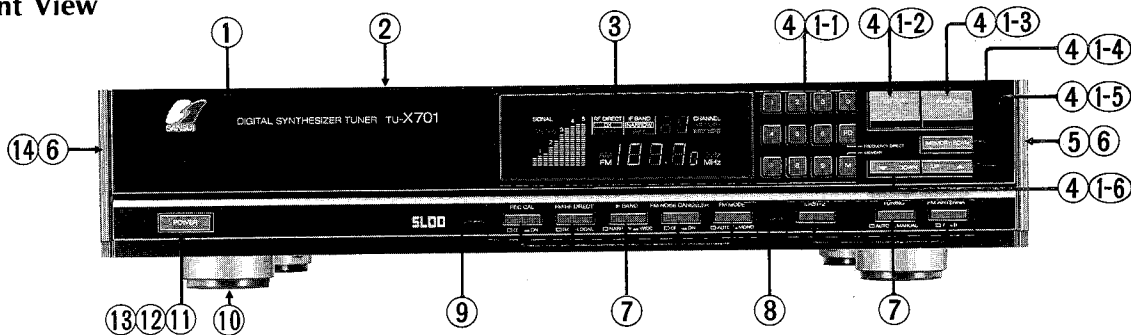

Parts List < Front View >

Parts No.	Stock No.	Description	Parts No.	Stock No.	Description
1	27414420	Front Panel Ass'y	7	27388700	Knob, ANTENNA•TUNING•LAST-2•FM MODE•FM NOISE CANCELER•IF DIRECT•REC CAL
1-1	—	Knob Ass'y	8	48839000	Push SW. (3-key), ANTENNA•TUNING•LAST-2
1-2	—	ENTER Knob	9	48839100	Push SW. (5-key), FM MODE•FM NOISE CANCELER•IF DIRECT REC CAL
1-3	—	FM/AM Knob	10	47716600	Leg
1-4	—	MEMORY SCAN Knob	11	27420500	POWER Knob
1-5	—	UP Knob	△12	46360300	Push SW., POWER
1-6	—	DOWN Knob	13	47920800	Joint Shaft, POWER Knob
2	27389300	Bonnet	14	27321910	Dress Side Panel L
3	48903800	FL Display Tube			
4	48592000	Push SW., 1~0 (preset)•ENTER•FM/AM•MEMORY SCAN•UP•DOWN			
5	27293110	Dress Side Panel R			
6	48719700	Special Screw			

7-2. Top View

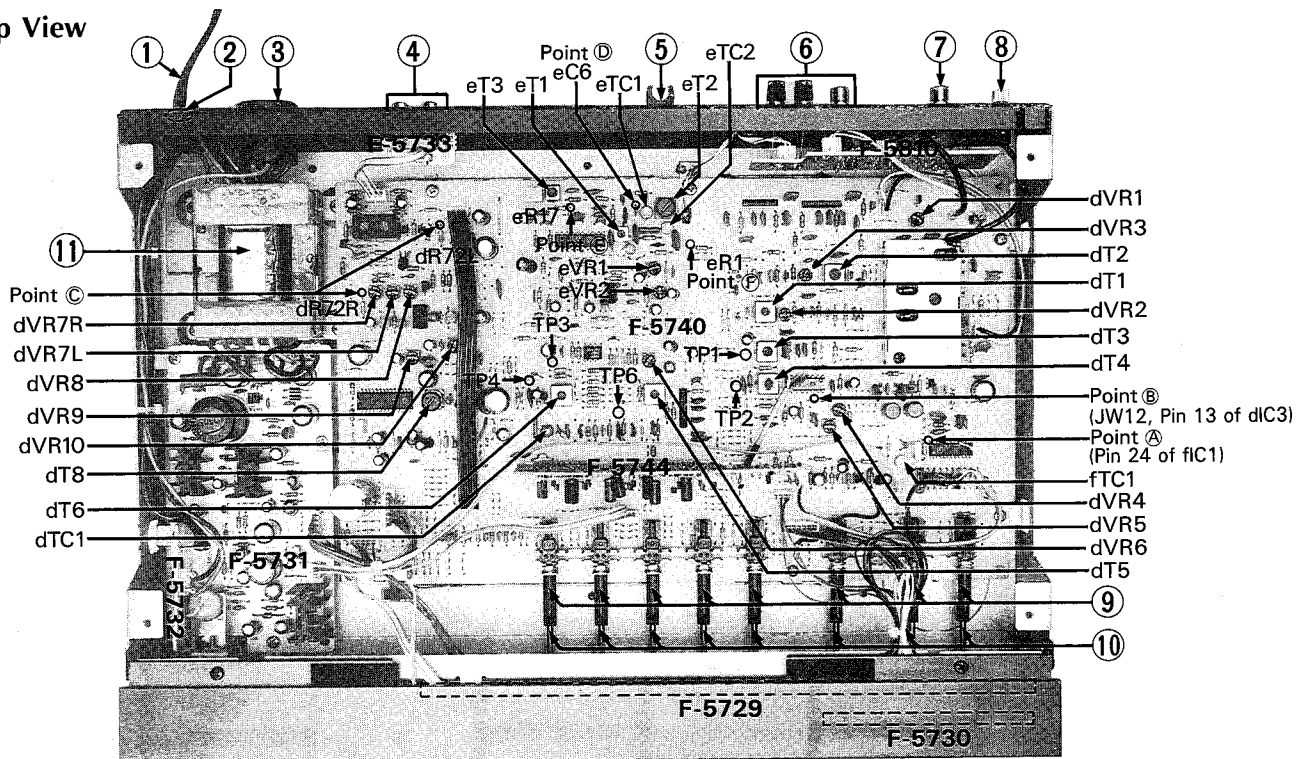

Parts List <Top View>

Parts No.	Stock No.	Description
△ 1	46604400	Power Supply Cord (XX)
△	48585000	Power Supply Cord (UL)
△	48187700	Power Supply Cord (CSA)
△	38004500	Power Supply Cord (EU·SEV)
△	48837700	Power Supply Cord (SS)
2	39106000	Strain Relief (XX·UL·CSA)
	48913500	Strain Relief (EU·SEV·SS)
△ 3	48175200	Voltage Selector (XX)
△	07204700	Slide SW., Voltage Selector (EU·SEV)
4	48948500	2P Terminal Board, OUTPUT
5	07193200	AM Antenna Holder

Parts No.	Stock No.	Description
6	48913900	Antenna Terminal (XX·UL·CSA·SS)
	48948900	Antenna Terminal (EU·SEV)
7	48845300	FM Antenna Terminal (F-Type), (XX·UL·CSA·SS)
	48976500	FM Antenna Terminal (EU·SEV)
8	48587600	GND Terminal
9	27388600	Joint for Push SW.
10	27415000	Rod for Push SW.
△ 11	15029409	Power Transformer (XX·SS)
△	15029402	Power Transformer (UL·CSA)
△	15029405	Power Transformer (EU·SEV)

8. DESCRIPTION OF FV171G, FL DISPLAY

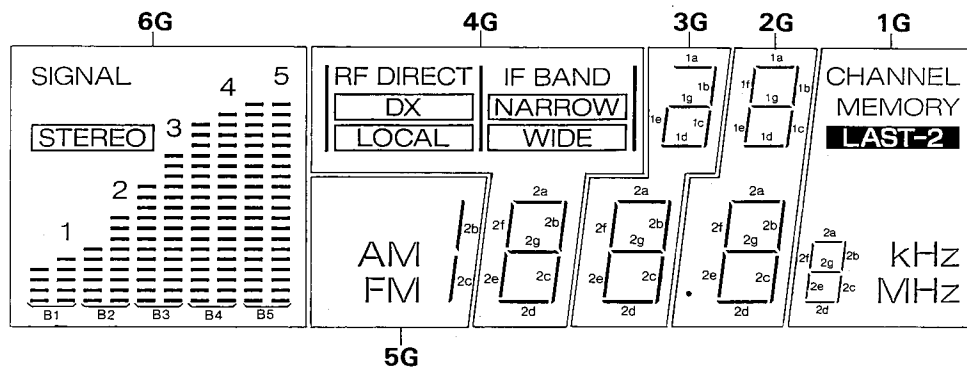

PIN CONNECTION

PIN NO.	1	2	3	4	5	6	7	8	9	10	11	12	13	14	15	16	17	18	19	20	21	22	23	24	25	26	27	28	29	30	31	32	33	34	35	36	37	38	39	40	41	42				
CONNECTION	F	F	N	s	r	t	q	p	N	P	N	P	N	P	6	G	5	4	3	2	1	N	o	h	i	m	N	n	j	l	k	N	P	C	a	b	f	N	g	c	e	d	N	P	F	F

Grid Anode	6G	5G	4G	3G	2G	1G
a	STEREO	—	—	1a	1a	MEMORY
b	—	—	—	1b	1b	LAST-2
c	B3	—	—	1c	1c	kHz
d	B1	FM	—	1d	1d	MHz
e	B2	AM	—	1e	1e	—
f	B5	—	—	—	1f	—
g	B4	—	—	1g	1g	—
h	—	—	2a	2a	2a	—
i	—	2b	2b	2b	2b	—
j	—	2c	2c	2c	2c	2be

Grid Anode	6G	5G	4G	3G	2G	1G
k	—	—	2d	2d	2d	2acdf
l	—	—	2e	2e	2e	2g
m	—	—	2f	2f	2f	—
n	—	—	2g	2g	2g	—
o	—	—	—	—	•	—
p	SIGNAL 12345	—	RF DIRECT IF BAND	—	—	CHANNEL
q	—	—	LOCAL	—	—	—
r	—	—	WIDE	—	—	—
s	—	—	NARROW	—	—	—
t	—	—	DX	—	—	—

9. SCHEMATIC DIAGRAM 9-1. Control and Display Section

A B C D

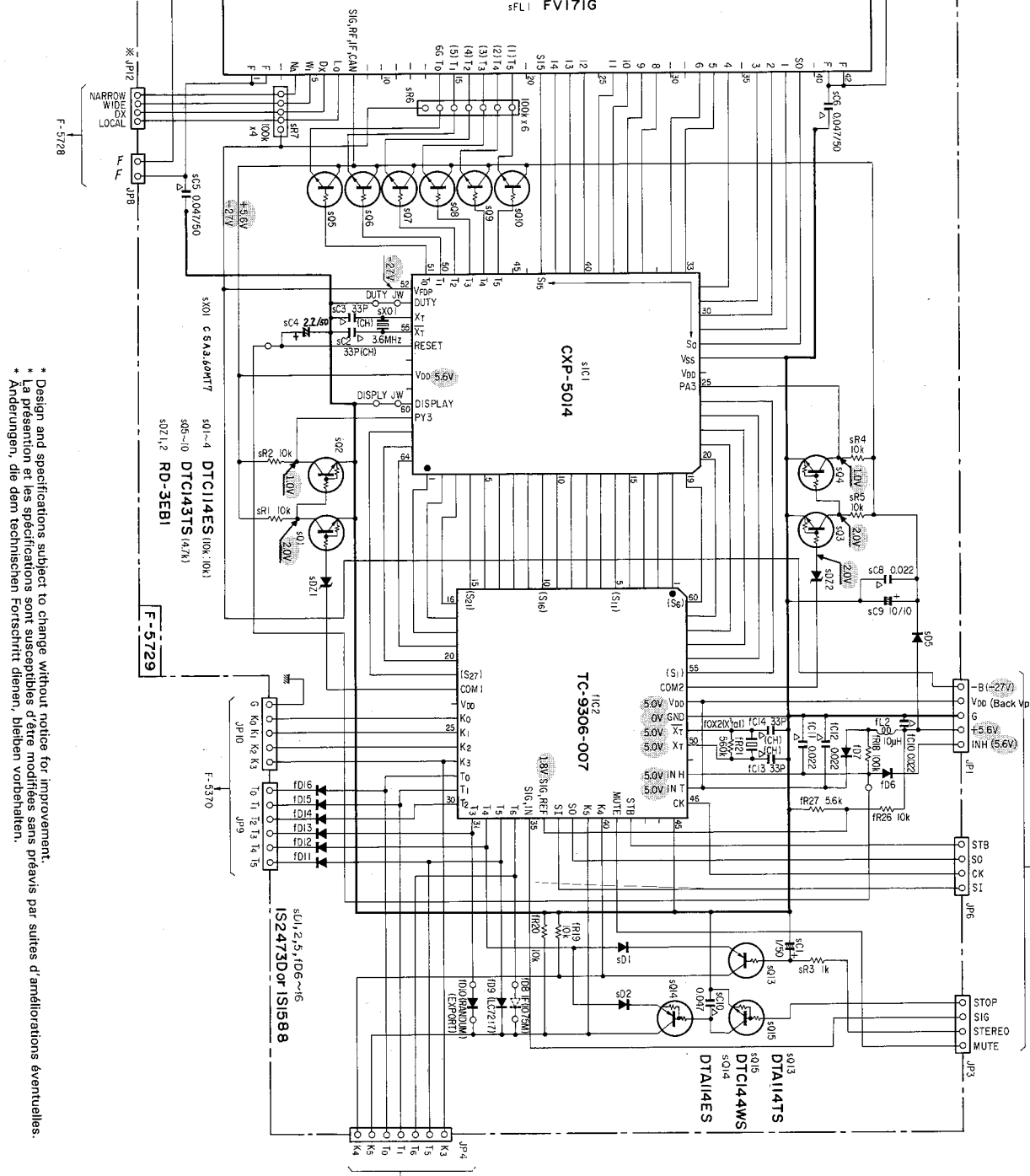

* Design and specifications subject to change without notice for improvement.
 * La présentation et les spécifications sont susceptibles d'être modifiées sans préavis par suites d'améliorations éventuelles.
 * Änderungen, die dem technischen Fortschritt dienen, bleiben vorbehalten.

- 2SA934
2SD438
- 2SB507
2SD880
- 2SA1175
2SC2785
DTA124ES
DTC114TS.YS
DTC124XS
DTC143TS
DTC144ES
- 2SK192A
- PC1163H
TA7302P
- LA1245
LA3450
LC7217
NJM2043D
Det or Slot or Line
- TC9306
- AN78N05
- CXP5014
- 1N60P
1S1588
1S2473
10E2
M1204
- 1S133
- KV1226
- 05Z8.2
05Z22
RD3.0E
RD5.1F
- 2SA1048
2SC2458
2SC2603
- 2S1103
- 2SK117
2SK163
- 2SK241
- 10DF2
- UB152
- 1SV99

1
2
3
4
5

ON OF ICs, TC9306 AND CXP5014

ing System Control>

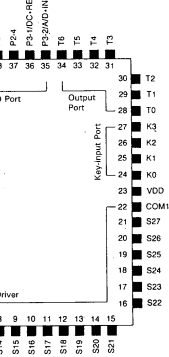

Function>

Function
 outputting common signals to FL
 IC.
 output is fixed at "L" level automa-
 tically when the system is reset or ex-
 ecuting CK STP instruction.
 outputting segment signals to FL
 or IC. A control of a maximum of
 16 is possible on the basis of matrix
 and COM2. Data are outputted
 as terminals when SEG instruction (COM2
 term) or MARK instruction (COM2
 executed.
 output is fixed at "L" level when
 system is reset or executing CK STP
 instruction.

iver>

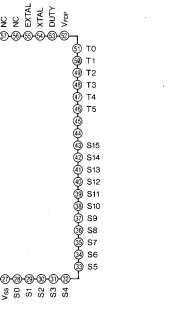

◆ CXP5014 <Terminal Function>

Pin No.	Pin Name	I/O	Description
1 - 24	PX3, PPD - 3, PCO - 3, PFO - 3, PEO - 3, PBO - 3, PAO - 2 PXO - 2	i	Terminal for inputting a FL display indicator driving signals.
25	COM2	i	Terminal for inputting common signal for FL display.
26, 59	V _{CC}	-	Terminals for applying a device supply voltage.
27, 60	GND	-	GND Terminal
28 - 43	S1 - S15	O	Terminals for outputting segment signals to FL display.
46 - 51	T5 - T0	O	Terminals for outputting grid signals to FL display.
S2	V _{REF}	-	Terminal for connecting a supply voltage (-) to filament of FL display.
53	DUTY	i	Terminal for setting a display mode for FL display. Normally this terminal is kept in "L" level.
54, 55	XT, XT	-	Terminal for connecting a quartz oscillator of 3.6 MHz.
58	RESET	-	Terminal for inputting a reset signal.
61	COM1	i	Terminal for inputting common signal for FL display.

11. INTERIOR BLOCK DIAGRAM OF ICs

•LC3450 (MPX)

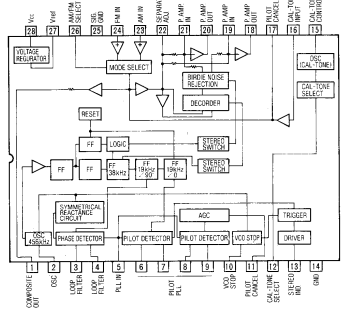

•TA7302P (FM IF Amp.)

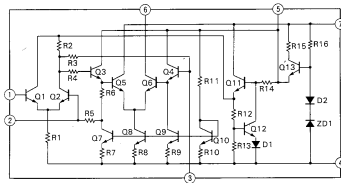

•μPC1163H (FM IF Amp.)

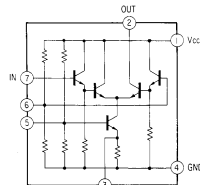

•LC7217 (PLL Synthesizer)

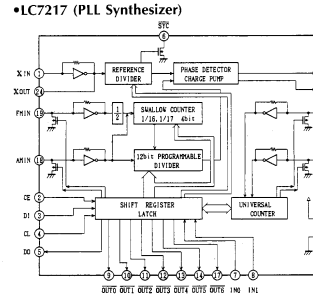

•LA1235 (IF Amp. •Detector •Muting •Signal Meter Drive)

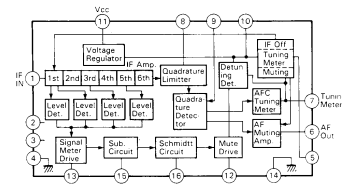

•LA1245 (AM Tuner)

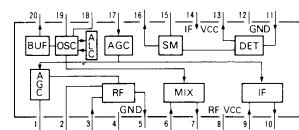

•NJM2043D (OP Amp.)

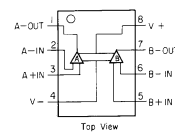

SANSUI ELECTRIC CO., LTD.: 14-1, Izumi 2-chome, Suginami-ku, Tokyo 168 Japan
 PHONE: (03) 324-8891 TELEX: 232-2378 (International Division)
 SANSUI ELECTRONICS CORPORATION: 1250 Valley Brook Ave. Lyndhurst, N.J. 07071 U.S.A.
 17150 South Margay Ave. Carson, California 90746 U.S.A.
 SANSUI ELECTRONICS (U.K.) LTD.: 302R Kosaka Street, Honolulu, Hawaii 96819 U.S.A.
 SANSUI ELECTRONICS G.M.B.H.: Unit 10A, Lyon Industrial Estate, Rockware Avenue, Greenford, Middx UB8, OAA, England
 山水電気株式会社: Paul Ehrlich Strasse 9, 6074 Riedemark 2, West Germany
 H.E.国内営業部 サービス推進部 東京都三鷹市下連雀3-9-16(〒181) 電話0422-46-8131
 (SM2-1) Printed in Japan (11987.07.MI) <Stock No. 36531500>