



KENWOOD
HI/FI STEREO COMPONENTS

SERVICE MANUAL

KT-815 (KT-8155)

An item of adjustment is written in three languages — English, French and German.

Un article sur réglages est écrit en trois langues, Anglais, Français et Allemand.

Ein Artikel der Abgleich wird auf drei Sprachen, Englische, Französisch und Deutsch geschrieben.

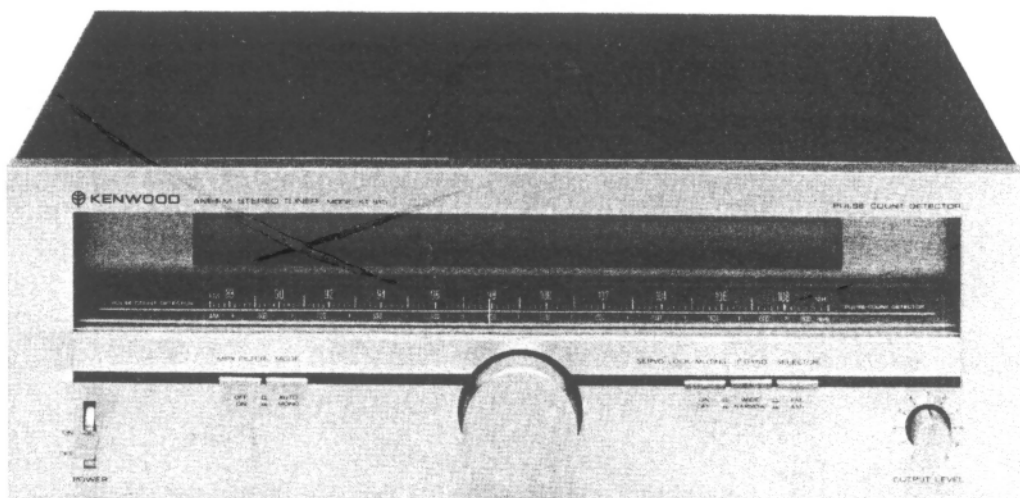

AM-FM STEREO TUNER

CONTENTS

EXTERNAL VIEW 3

INTERNAL VIEW 4

DIAL CORD STRINGING 4

BLOCK DIAGRAM 5

EXPLODED VIEW 6

ADJUSTMENT

 ADJUSTMENT 7

 RÉGLAGES 9

 ABGLEICH 11

PC BOARD 13

SEMICONDUCTOR SUBSTITUTIONS 14

SCHEMATIC DIAGRAM 15

SPECIFICATIONS 15

WAVEFORMS AT CHECK POINTS 16

PARTS LIST 17

Note:

Component and circuitry are subject to modification to insure best operation under differing local conditions. This manual is based on the U.S. (K) standard, and provides information on regional circuit modification through use of alternate schematic diagrams, and information on regional component variations through use of parts list.

Region	Code
U.S.A.	K
Canada	P
PX	U
Australia	X
Europe & Scandinavia	E
England	T
South Africa	S
Other Areas	M
Audio Club (KT-8155)	H

EXTERNAL VIEW

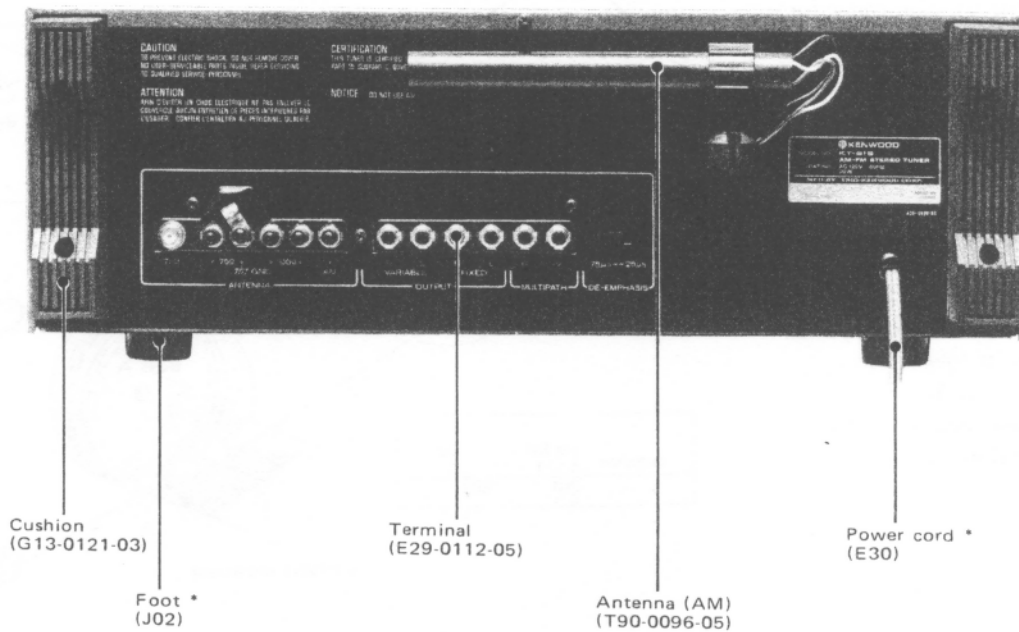
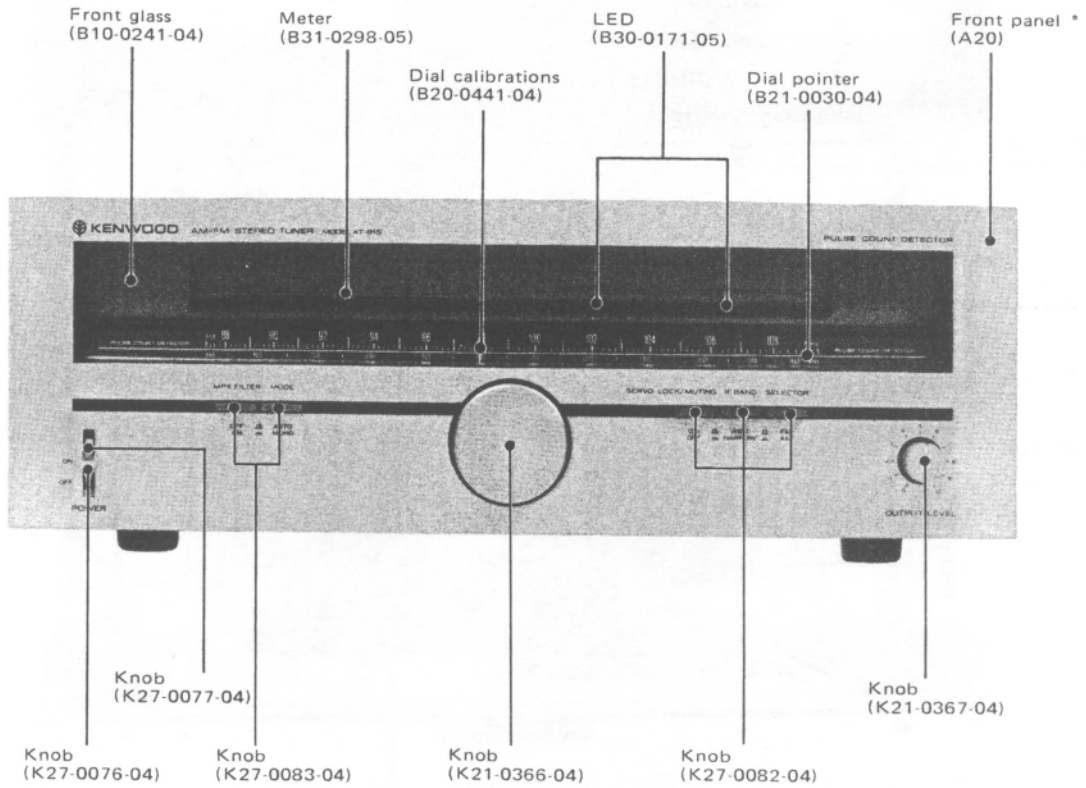

* Refer to Parts List.

INTERNAL VIEW / DIAL CORD STRINGING

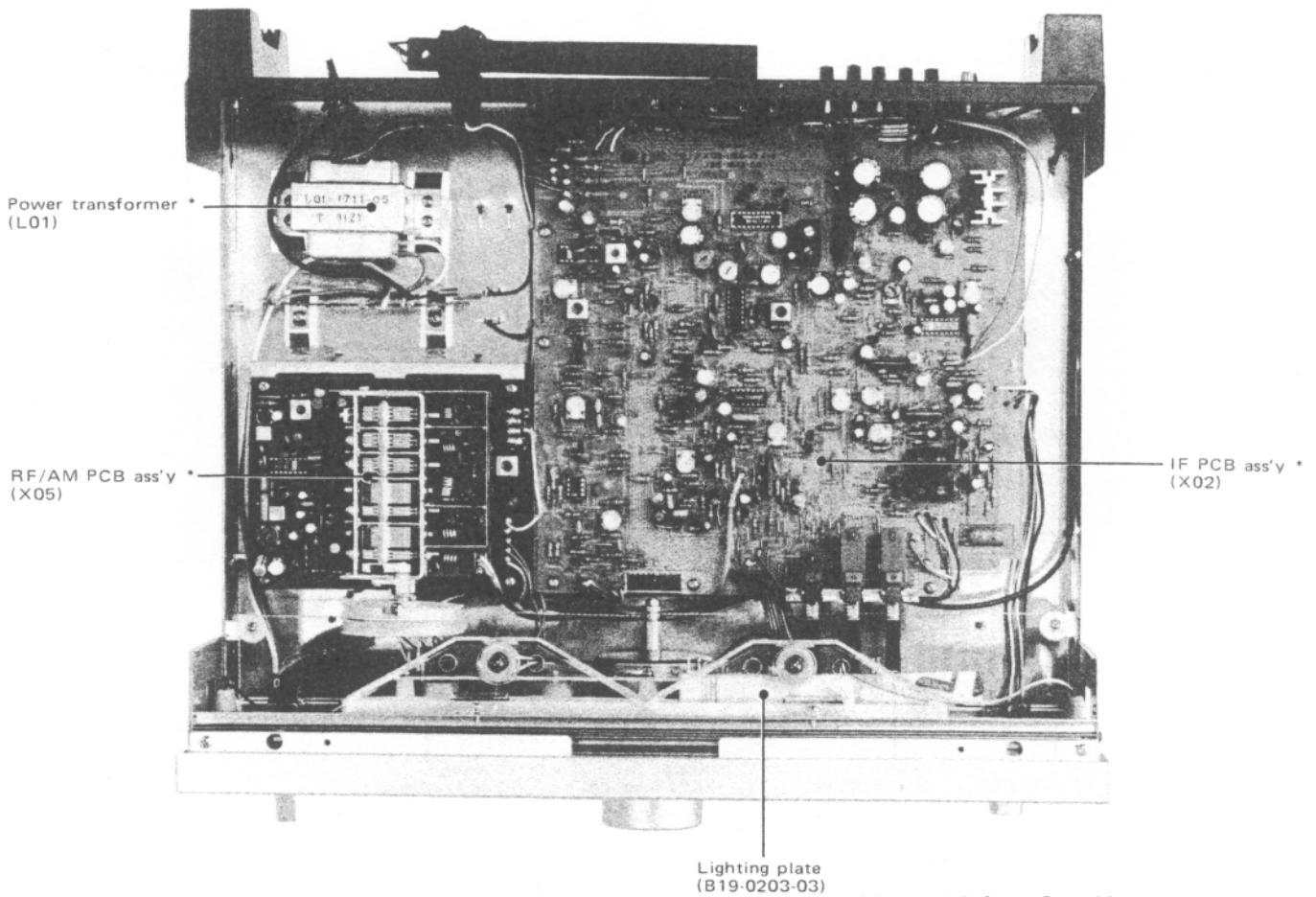

* Refer to Parts List.

DIAL CORD STRINGING

1. Fully close the variable capacitor.
2. Set the dial pulley as illustrated.
3. Tie the end of the dial cord to the boss A as shown.
4. Dress the dial cord in the direction of "1" and wind 2 turns around the dial shaft starting from its lower side.
5. Dress the dial cord in the direction of "2" through "7" and wind it 2 turns around the dial pulley starting from its lower side.
6. Fix it to the boss B.
7. Mount the dial pointer as shown in the illustration.

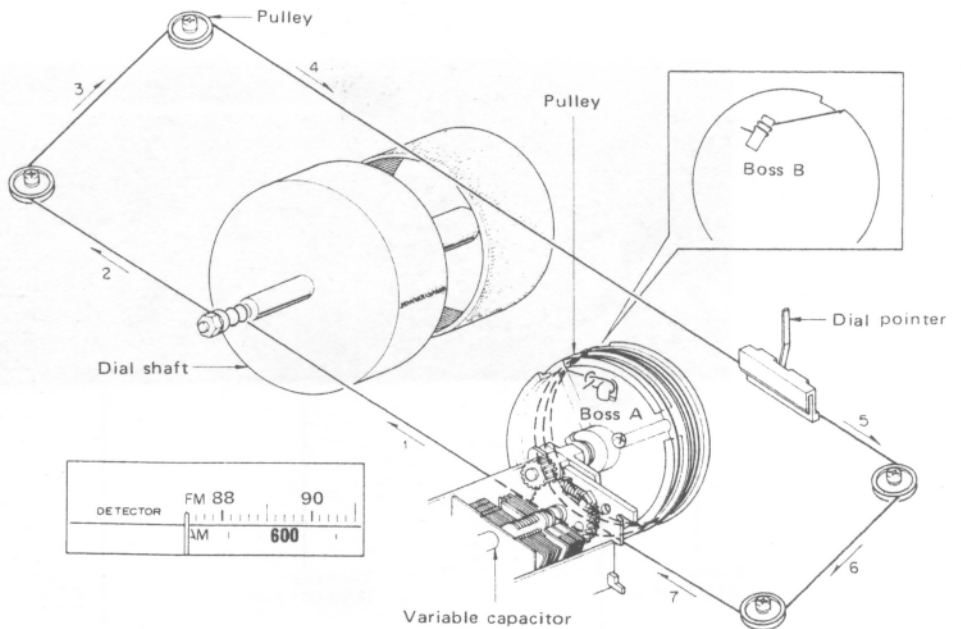

BLOCK DIAGRAM

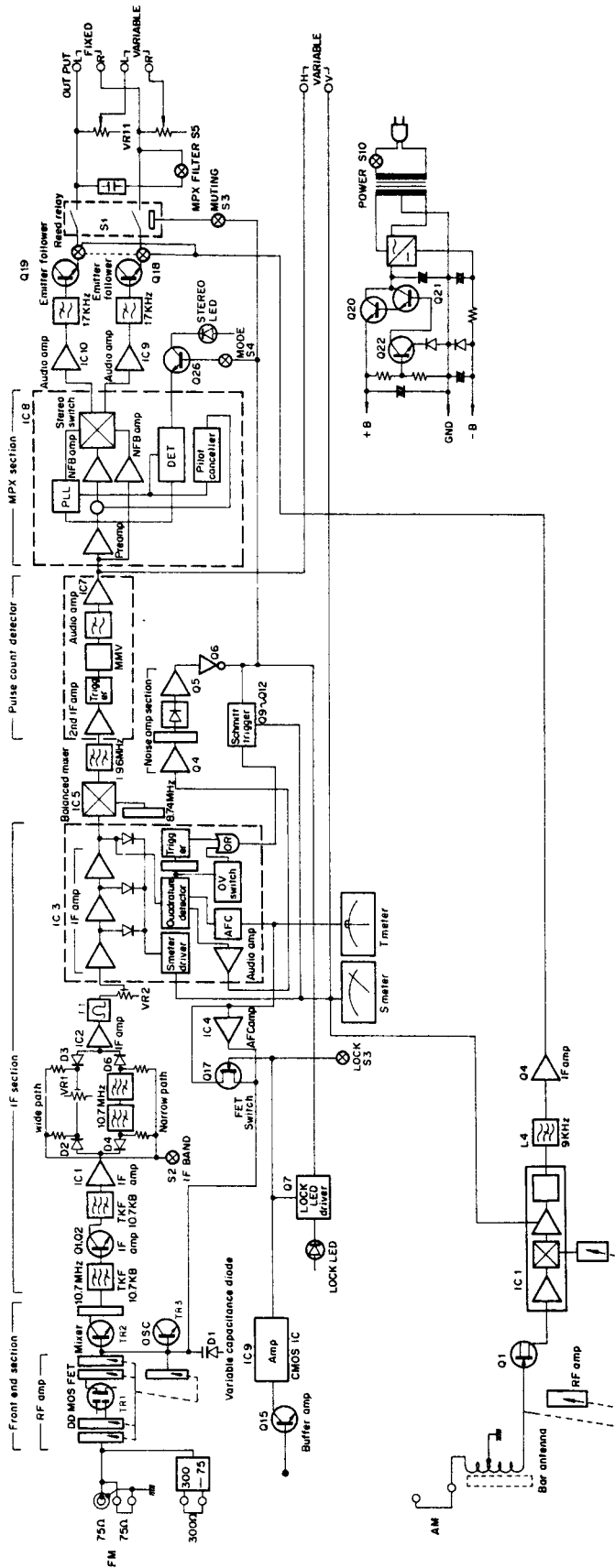

EXPLODED VIEW

See parts numbers on page 16.

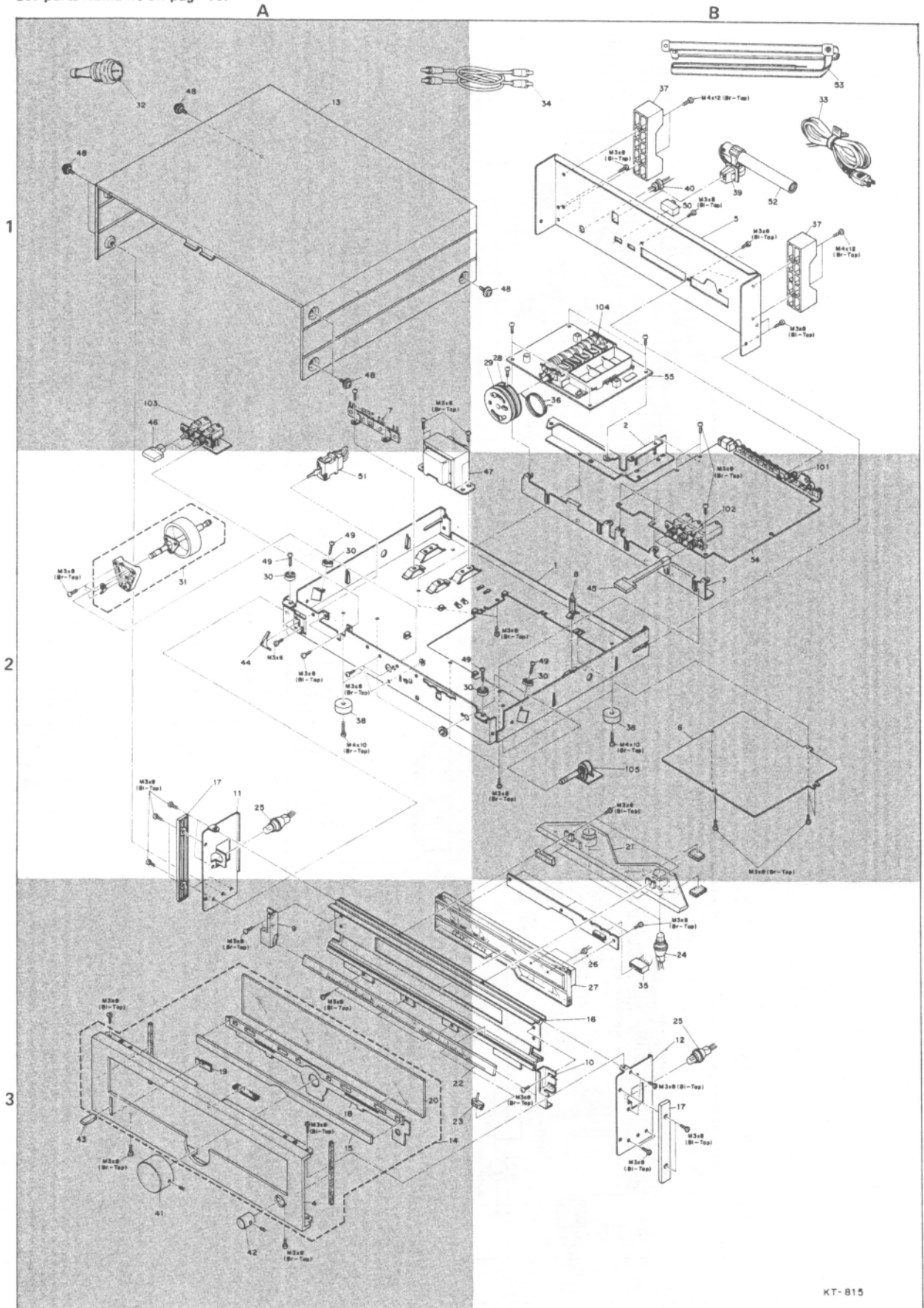

ADJUSTMENT

Set MUTING switch to OFF, MODE switch to STEREO, IF BAND switch to WIDE and MPX FILTER switch to OFF, unless otherwise specified.

NO.	ALIGNMENT	TEST EQUIPMENTS		TUNER SETTING	OUTPUT INDICATOR	ADJUSTMENT POINTS	REMARKS
		CONNECTION	SETTINGS				
FM SECTION							
1	IFT	Ⓐ, Ⓑ	95MHz 1kHz, ±75MHz Dev	95MHz	Lissajous' figure	L5(X05-1660) T1(X02-1180)*2	Symmetrical waveform and maximum deflection
2a	T METER	Ⓑ	ditto	ditto	Ⓒ	—	*2
2b	T METER	ditto	95MHz 1kHz, ±75kHz Dev 60dB *3	ditto	T meter	T2	T meter pointer to be center
3	DISTORTION	Ⓓ	95MHz 1kHz, ±68.25kHz Dev SELECTOR: L+R 60dB *3	ditto	Ⓒ	L5(X05-1660)	Minimum distortion
Set VR2 ~ VR4 each to center.							
4	MUTING LEVEL	Ⓑ	95MHz 1kHz, ±75kHz Dev 20dB*3	95MHz MUTING: ON NARROW	Ⓒ	VR2	*4
5	S METER	ditto	95MHz 0 Dev 100dB*3	95MHz NARROW	S meter	VR4	*5
6a	WIDE GAIN	ditto	95MHz 0 Dev	ditto	ditto	—	*6
6b	WIDE GAIN	ditto	Same as 6a	95MHz WIDE	ditto	VR1	*7
7	NOISE AMP	ditto	95MHz 1kHz, ±75kHz Dev SG output level*8	95MHz NARROW	DC voltmeter to the cathode of D8	VR3	*9
8	T METER OFFSET	ditto	95MHz 1kHz, ±75kHz Dev 60dB*3	95MHz WIDE	T meter	VR10	*10
9	VCO	ditto	95MHz 0 Dev 60dB*3	ditto	Frequency counter to the crosspoint of R114 and VR5	VR5	76kHz
10a	SEPARATION (1)	Ⓓ	95MHz *11 1kHz, ±68.25kHz Dev SELECTOR: R 60dB*3	ditto	Ⓒ	VR7	Minimum crosstalk
10b	SEPARATION (2)	ditto	95MHz *11 1kHz, ±68.25kHz Dev SELECTOR: L 60dB*3	ditto	ditto	VR8	ditto
10c	SEPARATION (3)	ditto	95MHz *11 1kHz, ±68.25kHz Dev SELECTOR: L (R) 60dB*3	95MHz NARROW	ditto	VR9	ditto
11	PILOT CANCELLER	Ⓑ	95MHz 60dB*3 Pilot signal	95MHz WIDE	ditto	VR6	Minimum output
AM SECTION							
1	IF	Ⓔ	1000kHz 400Hz, 30% Mod	1000kHz	Ⓒ	L2 (X05-1660)	Maximum deflection
2a	TRACKING	ditto	600kHz 400Hz, 30% Mod	600kHz	ditto	L1 (X05-1660) AM bar antenna	ditto
2b	TRACKING	ditto	1400kHz 400Hz, 30% Mod	1400kHz	ditto	CT1, CT2 (X05-1660)	ditto

ADJUSTMENT

TEST INSTRUMENTS

- Oscilloscope
- AM signal generator AM-SG
- FM signal generator FM-SG
- Audio generator AG
- Solid state voltmeter SSVM
- FM multiplex generator FM-MPX
- Frequency counter
- DC voltmeter

NOTES ON ADJUSTMENT

*** 1**

IFT T1 needs no adjustment. When it is replaced with a new one, it should be adjusted with an IF detector. *PG13* →

*** 2**

Adjust the tuning knob so that the same amount of noise is observed at the top and bottom of the output waveform with a weak signal.

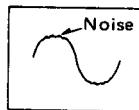

*** 3**

Tuner input level

*** 4**

Turn VR2 until the output waveform disappears, then turn it slightly in the opposite way until the output waveform appears again. *MUTING*

*** 5**

Set VR4 so that the S meter indicates "4.75".

*** 6**

Set the SG output level so that the S meter indicates "3".

*** 7**

Set VR1 so that the S meter indicates "3".

*** 8**

Level corresponding to a "monophonic usable sensitivity (IHF)".

*** 9**

Set VR3 so that the cathode potential of D8 is lower than the source potential of Q3 by 1 V. *Noise AMP*

*** 10**

First, set MUTING-LOCK switch to OFF, and tune the tuner to a 95 MHz signal. In this case, the T meter pointer should be on center. Then, set MUTING-LOCK switch to ON, and set VR10 so that the T meter pointer is on center.

*** 11**

Set deviation to ±68.25 kHz with selector in L+R position. Set deviation of pilot signal to 6.75 kHz (9%). *T METER OFFSET*

*** 12**

The front end section has already been completely adjusted in the factory and further adjustment is not necessary. If the ceramic trimmers or the coils are accidentally moved, perform the following adjustment. (MUTING-LOCK switch: OFF)

- 1) If the ceramic trimmers have been moved:
 1. Set FM-SG to 108 MHz, 1 kHz Mod., ±75 kHz Dev. and connect it to the antenna terminal of the tuner.
 2. Set the dial pointer at 108 MHz.
 3. Adjust TCO so that the T meter gives a mid-scale reading.
 4. Adjust TCA1, TCA2, TCR1 and TCR2 so that maximum output is obtained.
- 2) If the coils have been moved:
 1. Set FM-SG to 88 MHz, 1 kHz Mod., ±75 kHz Dev. and connect it to the antenna terminal of the tuner.
 2. Set the dial pointer at 88 MHz.
 3. Adjust the coil pitch of L7 with a screwdriver or the like so that the SG signal is received.
 4. Adjust the coil pitch of L1~L5 with a screwdriver or the like so that maximum output is obtained.

*** 13**

If the front end cannot be repaired by ① replacing semi-conductors and/or ② taking steps in *12, replace the front end PCB ass'y (W02-0021-05) and do the following.

1. Set FM-SG to 90 MHz, 1 kHz Mod., ±75 kHz Dev. and connect it to the antenna terminal of the tuner.
2. Adjust the tuner so that the SG signal is received. (MUTING-LOCK switch: OFF)
3. Fix the dial pointer at 90 MHz.

*** 14**

Adjustment of the Second Oscillator (T3)
 T3 needs no adjustment. When it is replaced with a new one, it should be adjusted as follows.
 First, tune the tuner to a 95 MHz non-modulated signal, and measure the first IF frequency of the positive end of T3 by a frequency counter. Next, adjust T3 so that the second IF frequency of the connecting point of FL2 and R90 is " $\frac{9}{49}$ X the first IF frequency".

IF a frequency counter which can measure 10.7 MHz is not available, regard the central frequency of a ceramic filter as a first IF frequency.

Black:	10.64 MHz	Orange:	10.72 MHz
Brown:	10.66 MHz	Gray:	10.74 MHz
Blue:	10.68 MHz	White:	10.76 MHz
Red:	10.70 MHz		

*** 15**

0 dB = 1 μV

RÉGLAGES

Placer le MUTING dans la position OFF, MODE sur STÉRÉO, IF BAND sur WIDE et MPX FILTER sur OFF, sauf indiqué spécialement.

N°	ALIGNEMENT	APPAREILLAGE		RÉGLAGE DU TUNER	INDICATEUR DE SORTIE	POINTS DE RÉGLAGES	REMARQUES
		RACCORDEMENT	RÉGLAGE				
SECTION MF							
1	TFI	(A), (B)	95MHz 1kHz (MOD) ±75kHz (DÉV)	95MHz	Figure de Lissajou	L5 (X05-1660) T1(X02-1180) *1	Forme d'onde symétrique et déflexion maximale.
2a	INDICATEUR À ZÉRO CENTRAL	(B)	idem	idem	(C)	—	* 2
2b	INDICATEUR À ZÉRO CENTRAL	idem	95MHz 1kHz (MOD) ±75kHz (DÉV) 60dB *3	idem	Indicateur à zéro central	T2	Aiguille de l'indicateur à zéro central en position centrale.
3	DISTORSION	(D)	95MHz 1kHz (MOD) ±68,25kHz (DÉV) L+R (SELECTION) 60dB *3	idem	(C)	L5 (X05-1660)	Distorsion minimale
Tourner VR2 ~ VR4 à position de centre.							
4	MUTING	(B)	95MHz 1kHz (MOD) ±75kHz (DÉV) 20dB *3	95MHz MUTING: ON NARROW	(C)	VR2	* 4
5	INDICATEUR DE CHAMP	idem	95MHz 0 (DÉV) 100dB *3	95MHz NARROW	Indicateur de champ	VR4	* 5
6a	GRAND GAIN	idem	95MHz 0 (DÉV)	idem	idem	—	* 6
6b	GRAND GAIN	idem	Mêmes conditions que 6a.	95MHz WIDE	idem	VR1	* 7
7	AMPLIFICATEUR DE BRUIT	idem	95MHz 1kHz (MOD) ±75kHz (DÉV) ENTRÉE ANT *8	95MHz NARROW	Relier le voltmètre CC à l'anode de D8	VR3	* 9
8	INDICATEUR À ZÉRO CENTRAL (OFFSET)	idem	95MHz 1kHz (MOD) ±75kHz (DÉV) 60dB *3	idem	Indicateur à zéro central	VR10	* 10
9	OSCILLATEUR 76kHz	idem	95MHz 0 (DÉV) 60dB *3	idem	Relier le voltmètre CC au plot R114 et VR5	VR5	76kHz
10a	SÉPARATION	(D)	95MHz 1kHz (MOD) ±68,25kHz (DÉV) R (SELECTION) 60dB *3	idem	(C)	VR7	Diaphonie minimale
10b	SÉPARATION	idem	95MHz 1kHz (MOD) ±68,25kHz (DÉV) L (SELECTION) 60dB *3	idem	idem	VR8	idem
10c	SÉPARATION	idem	95MHz 1kHz (MOD) L ou R (SELECTION) 60dB *3	95MHz NARROW	idem	VR9	idem
11	CIRCUIT SUPPRESSION DE SIGNAL PILOTE	(B)	95MHz 60dB *3 Signal pilote	95MHz WIDE	idem	VR6	Déviaton maximale
SECTION MA							
1	TFI	(E)	1.000kHz 400Hz, 30% (MOD)	1.000kHz	(C)	L2 (X05-1660)	Déviaton maximale
2a	ALIGNEMENT	idem	600kHz 400Hz, 30% (MOD)	600kHz	idem	L1 (X05-1660) Antenne ferrite MA	idem
2b	ALIGNEMENT	idem	1.400kHz 400Hz, 30% (MOD)	1.400kHz	idem	CT1, CT2 (X05-1660)	idem

RÉGLAGES

APPAREILLAGE

Oscilloscope OSC
 Générateur MA AM-SG
 Générateur MF FM-SG
 Générateur audio fréquences AG
 Voltmètre à transistor SSVM
 Générateur multiplex stéréo FM-MPX
 Fréquencemètre
 Voltmètre CC

REMARQUE SUR LE RÉGLAGE

*** 1**
 Le TFI T1 n'a pas besoin d'être réglé. Lorsqu'il doit être remplacé par un neuf, procéder au réglage avec un détecteur FI.

*** 2**
 Ajuster le bouton d'accord de façon que la même quantité de bruit puisse être observé au sommet et en bas de la forme d'onde de sortie sous des conditions d'alimentation de signal faible.

*** 3**
 Niveau d'entrée du tuner.

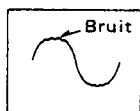

*** 4**
 Tourner VR2 jusqu'à ce que la forme d'onde de sortie disparaisse, le tourner ensuite légèrement dans le sens opposé jusqu'à ce que la forme d'onde de sortie apparaisse à nouveau.

*** 5**
 Régler VR4 de façon que l'indicateur de champ marque "4,75".

*** 6**
 Régler le niveau de sortie SG de façon que l'indicateur de champ marque "3".

*** 7**
 Régler VR1 de façon que l'indicateur de champ marque "3".

*** 8**
 Le niveau de sortie correspond à la sensibilité monophonique utile (IHF).

*** 9**
 Régler VR3 de façon que le potentiel de cathode de D8 soit inférieur de 1V au potentiel de source de Q3.

*** 10**
 Régler d'abord le commutateur de verrouillage de silencieux (MUTING-LOCK) sur OFF (hors-service), et accorder le tuner sur 95 MHz. Dans ce cas, l'aiguille d'indicateur d'accord doit être au milieu. Ensuite, régler le commutateur de MUTING-LOCK sur ON (en service), puis régler VR10 de façon que l'aiguille d'indicateur d'accord soit au milieu.

*** 11**
 Régler la déviation à $\pm 68,25$ kHz avec le sélecteur en position L+R (gauche + droite). Régler la déviation du signal pilote à 6,75 kHz (9%).

*** 12**
 La tête RF a déjà été complètement ajustée en usine et aucun ajustement ultérieur n'est requis. Si les condensateurs d'antenne céramiques ou les selfs sont déplacés accidentellement, procéder alors aux réglages suivants:

- 1) Dans le cas où les condensateurs d'antenne céramiques auraient été déplacés.
 1. Régler FM-SG à 108 MHz, 1 kHz Mod., ± 75 kHz Dev. et le connecter à la borne d'antenne du tuner.
 2. Régler l'aiguille du cadran à 108 MHz.
 3. Ajuster TCO de façon que l'indicateur d'accord donne la lecture moyenne à l'échelle.
 4. Ajuster TCA1, TCA2, TCR1 et TCR2 de façon à obtenir la sortie maximale.
- 2) Si les selfs ont été déplacés:
 1. Régler FM-SG à 88 MHz, 1 kHz Mod., ± 75 kHz Dev. et le connecter à la borne d'antenne du tuner.
 2. Régler l'aiguille du cadran à 88 MHz.
 3. Ajuster le pas de la self de L7 avec un tournevis ou outil semblable de façon à bien recevoir le signal SG.
 4. Ajuster le pas de la self de L1 ~ L5 avec un tournevis ou outil semblable de façon à obtenir la sortie maximale.

*** 13**
 Si la tête RF ne peut pas être réparée

- (1) en remplaçant les semi-conducteurs et/ou
- (2) en suivant les indications du *12, remplacer l'assemblage (W02-0021-05) de la tête RF et procéder comme il suit:
 1. Régler FM-SG à 90 MHz, 1 kHz Mod., ± 75 kHz Dev. et le connecter à la borne d'antenne du tuner.
 2. Ajuster le tuner de façon à bien recevoir le signal SG.
 3. Fixer l'aiguille du cadran sur 90 MHz.

*** 14**
 Ajustement du deuxième oscillateur (T3)
 Le T3 n'a pas besoin d'être réglé. Lorsqu'il doit être remplacé par un neuf, procéder au réglage comme il suit: Accorder d'abord le tuner à un signal non modulé de 95 MHz, et mesurer la première fréquence FI de l'extrémité positive de T3 à l'aide d'un compteur de fréquence. Ensuite, ajuster T3 de façon que la deuxième fréquence FI du point de connexion de FL2 et R90 soit "9/49 X première fréquence FI". Si l'on ne dispose pas d'un compteur de fréquence qui puisse mesurer 10,7 MHz, considérer la fréquence centrale d'un filtre céramique comme la première fréquence FI.

Noir:	10,64 MHz	Orange:	10,72 MHz
Brun:	10,66 MHz	Gris:	10,74 MHz
Bleu:	10,68 MHz	Blanc:	10,76 MHz
Rouge:	10,70 MHz		

*** 15**
 0 dB = 1 μ V

ABGLEICH

Falls nicht anders angegeben, steht der MUTING-Umschalter auf Stellung OFF, der MODE-Umschalter auf Stellung STEREO, der IF BAND-Umschalter auf Stellung WIDE und der MPX FILTER-Umschalter auf Stellung OFF.

Nr.	ABGLEICH	PRÜFEINRICHTUNG		TUNER EINSTELLUNG	AUSGANGS- ANZEIGE	EINSTELL- PUNKT	BEMER- KUNGEN
		ANSCHLÜSSE	EINSTELLUNG				
UKW-EMPFANGSABTEILUNG							
1	ZF-T	Ⓐ , Ⓑ	95MHz 1kHz, ±75kHz Hub	95MHz	Lissajous- Figur	L5 (X05-1660) T1 (X02-1180)*1	Maximaler Ausschlag und Symmetrisch Wellenform
2a	KANALMITTEN- ANZEIGER	Ⓑ	dito	dito	Ⓒ	—	* 2
2b	KANALMITTEN- ANZEIGER	dito	95MHz 1kHz, ±75kHz Hub 60dB*3	dito	Kanalmitten- anzeiger	T2	Den Zeiger des Kanalmitten- anzeiger mittig einstellen
3	KLIRRFAKTOR	Ⓓ	95MHz 1kHz, ±68,25kHz Hub Wähler: L+R 60dB*3	dito	Ⓒ	L5 (X05-1660)	Minimaler klirrfaktor
VR2 bis VR4 jeweils auf Mitte einstellen.							
4	RAUSCHSPERRE- PEGEL	Ⓑ	95MHz 1kHz, ±75kHz Hub 20dB*3	95MHz MUTING: ON NARROW	Ⓒ	VR2	* 4
5	FELDSTÄRKE- INSTRUMENT	dito	95MHz 0 Hub 100dB*3	95MHz NARROW	Feldstärke- instrument	VR4	* 5
6a	FELDSTÄRKE- INSTRUMENT (WEIT)	dito	95MHz 0 Dev	dito	dito	—	* 6
6b	FELDSTÄRKE- INSTRUMENT (WEIT)	dito	S. 6a.	95MHz WIDE	dito	VR1	* 7
7	GERÄUSCH VERSTÄRKER	dito	95MHz 1kHz, ±75kHz Hub Leistung*8	95MHz NARROW	Gleichspannungs- messer an die kathode von D8	VR3	* 9
8	OFFSET (KANALMITTEN- ANZEIGER)	dito	95MHz 1kHz, ±75kHz Hub 60dB*3	95MHz WIDE	Kanalmitten- anzeiger	VR10	* 10
9	SPANNUNGS- GEREGELTER OSZILLATOR	dito	95MHz 0 Dev 60dB*3	dito	Frequenzzähler zum kreuzungs- punkt von R114 und VR5	VR5	76kHz
10a	STEREO KANAL TRENNUNG(1)	Ⓓ	95MHz *11 1kHz, ±68,25kHz Dev Wähler: R 60dB*3	dito	Ⓒ	VR7	Minimales Übersprechen
10b	STEREO KANAL TRENNUNG(2)	dito	95MHz *11 1kHz, ±68,25kHz Dev Wähler: L 60dB*3	dito	dito	VR8	dito
10c	STEREO KANAL TRENNUNG(3)	dito	95MHz *11 1kHz, ±68,25kHz Dev Wähler: L (R) 60dB*3	95MHz NARROW	dito	VR9	dito
11	PILOTTON- UNTER- DRÜCKUNG	Ⓑ	95MHz 60dB*3 Pilotton	95MHz WIDE	dito	VR6	Minimaler Ausschlag
MW-EMPFANGSABTEILUNG							
1	ZF-T	Ⓔ	1000kHz 400Hz, 30% Mod	1000kHz	Ⓒ	L2 (X05-1660)	Maximaler Ausschlag
2a	EMPFANGS- BEREICH	dito	600kHz 400Hz, 30% Mod	600kHz	dito	L1 (X05-1660) MW-Ferritantenna	dito
2b	EMPFANGS- BEREICH	dito	1000kHz 400Hz,30% Mod	1400kHz	dito	CT1, CT2 (X05-1660)	dito

ABGLEICH

PRÜFINSTRUMENTE

- Oszilloskop OSC
- UKW-Signalgenerator FM-SG
- NF-Signalgenerator AG
- Transistor-Voltmeter SSVM
- UKW-Multiplexgenerator FM-MPX
- Frequenzzähler
- Gleichspannungsmesser

HINWEISE FÜR DIE EINSTELLUNG

*** 1**

Der ZF-Transformator T1 braucht nicht eingestellt zu werden. Beim Auswechseln die Einstellung mittels eines ZF-Detektor vornehmen.

*** 2**

Den Abstimmknopf so einstellen, daß an der oberen und unteren Grenze der Ausgangswellenform bei schwachem Signal dasselbe Geräusch auftritt.

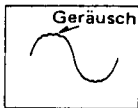

*** 3**

Tuner-Eingangspegel

*** 4**

VR2 drehen, bis die Ausgangs-Wellenform verschwindet; dann leicht in der entgegengesetzten Richtung drehen, bis die Ausgangswellenform wieder erscheint.

*** 5**

Das Trimm-Potentiometer VR4 so einstellen, daß das Feldstärkeinstrument den Wert 4,75 anzeigt.

*** 6**

Den Signalgenerator-Ausgangspegel so einstellen, daß das Feldstärkeinstrument den Wert 3 anzeigt.

*** 7**

Das Trimm-Potentiometer VR1 so einstellen, daß das Feldstärkeinstrument den Wert 3 anzeigt.

*** 8**

Pegel entsprechend der monofonen Nutzempfindlichkeit (IHF).

*** 9**

VR3 so einstellen, daß das Katodenpotential von D8 um 1 V niedriger ist als das Potential der source von Q3.

*** 10**

Zunächst der Muting-Lock-Umschalter auf Stellung OFF stellen und dann den Tuner auf ein 95 MHz Signal einstellen. In diesem Fall sollte der Kanalmitten-anzeiger in der Mitte stehen. Dann der Muting-Lock-Umschalter auf Stellung ON stellen daß die Nadel des Kanalmitten-anzeiger auf die Mitte zeigt.

*** 11**

Hub mit dem Wahlschalter auf L+R auf 68.25 kHz einstellen. Hub des Kontrollsignals auf 6.75 kHz (9%) einstellen.

*** 12**

Das Frontende wurde bereits im Werk vollständig eingestellt. Weitere Einstellung ist daher nicht nötig. Wenn die Keramiktrimmer oder die Spulen aus Versehen bewegt wurden, ist folgende Korrektur vorzunehmen:

- 1) Wenn die Keramiktrimmer bewegt wurden:
 1. Den UKW-Signalgenerator auf 108 MHz, 1 kHz Modulation und ± 75 kHz Hub einstellen und mit der Antennenklemme des Tuners verbinden.
 2. Den Skalenzeiger auf 108 MHz stellen.
 3. TCO so einstellen, daß der Kanalmitten anzeiger in der Mitte ausschlägt.
 4. TCA1, TCA2, TCR1 und TCR2 so einstellen, daß ein maximales Ausgangssignal erhalten wird.
- 2) Wenn die Spulen bewegt wurden:
 1. Den UKW-Signalgenerator auf 88 MHz, 1 kHz Modulation und ± 75 kHz Hub einstellen und mit der Antennenklemme des Tuners verbinden.
 2. Den Skalenzeiger auf 108 MHz stellen.
 3. Den Nutenschritt von L7 mit einem Schraubenzieher etc. so einstellen, daß ein Meß sendersignal erhalten wird.
 4. Den Nutenschritt von L1 bis L15 mit einem Schraubenzieher etc. so einstellen, daß ein maximales Ausgangssignal erhalten wird.

*** 13**

Wenn das Frontende (1) durch Auswechseln der Halbleiter und/oder (2) durch die in Abschnitt 12 genannten Schritte nicht repariert werden kann, ist die Leiterplatte (W02-0021-05) des Frontendes auszuwechseln und folgende Einstellung vorzunehmen:

1. Den UKW-Signalgenerator auf 90 MHz, 1 kHz Modulation und ± 75 kHz Hub einstellen und mit der Antennenklemme des Tuners verbinden.
2. Den Tuner so einstellen, daß das Meß sendersignal empfangen wird, während der Skalenzeiger auf 90 MHz zeigt.

*** 14**

Einstellung des zweiten Oszillators (T3)
 T3 braucht nicht eingestellt zu werden. Beim Auswechseln die Einstellung wie folgt vornehmen. Zunächst den Tuner auf ein nichtmoduliertes 95 MHz Signal einstellen. Dann die erste ZF der positiven Seite von T3 mit einem Frequenzzähler messen. Schließlich T3 so einstellen, daß die zweite ZF des Verbindungspunkts von FL2 und R90 dem Produkt aus 9/49 und der ersten ZF entspricht. Wenn kein Frequenzzähler, mit dem 10,7 MHz gemessen werden kann, zur Verfügung steht, kann die Mittenfrequenz eines Keramikfilters als erste ZF dienen.

Schwarz:	10,64 MHz	Braun:	10,66 MHz
Blau:	10,68 MHz	Rot:	10,70 MHz
Orange:	10,72 MHz	Grau:	10,74 MHz
Weiß:	10,76 MHz		

*** 15**

0 dB = 1 μ V.

ADJUSTMENT

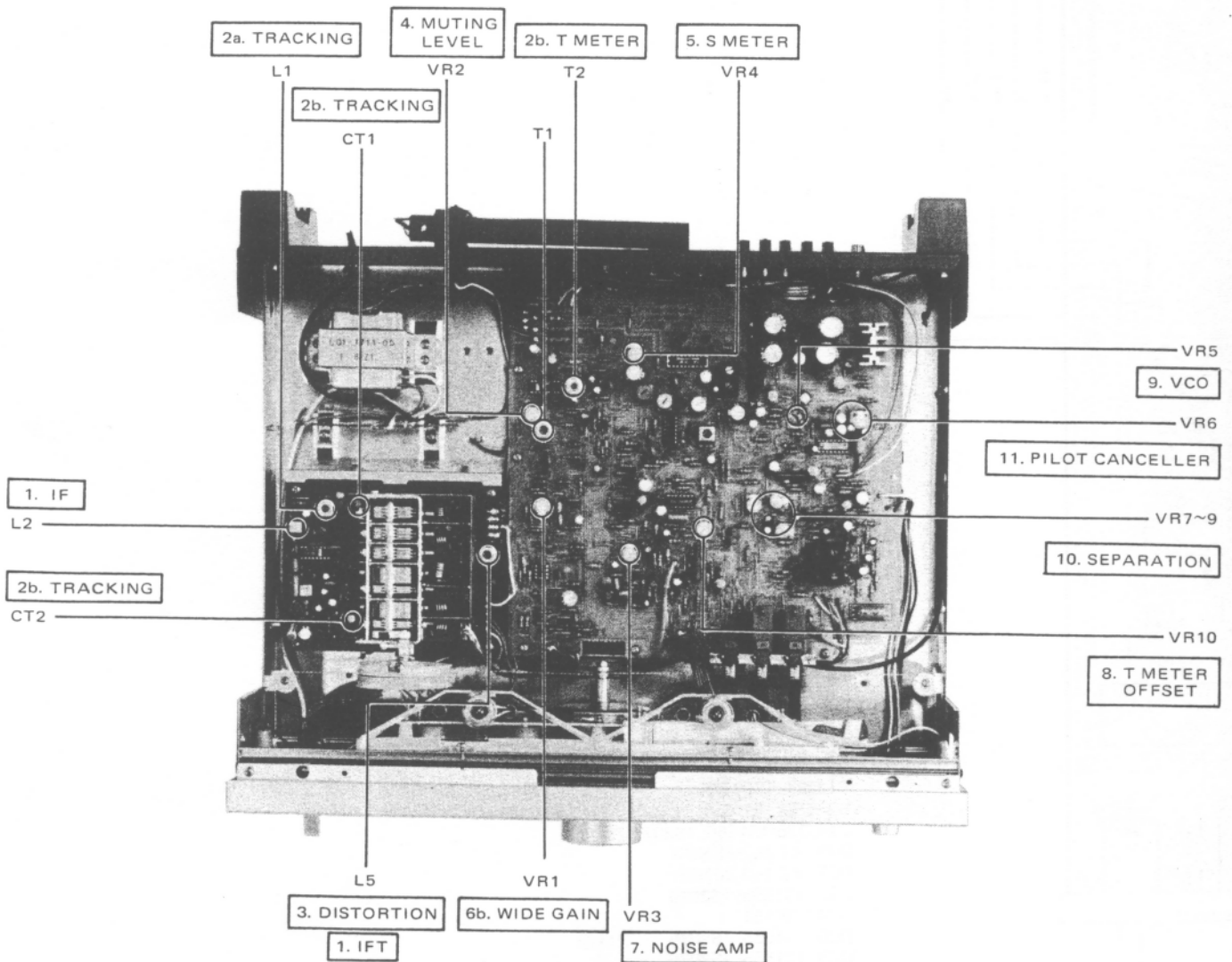
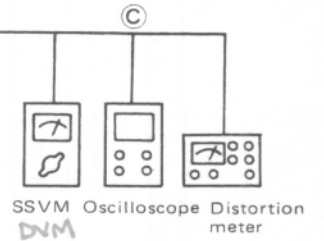
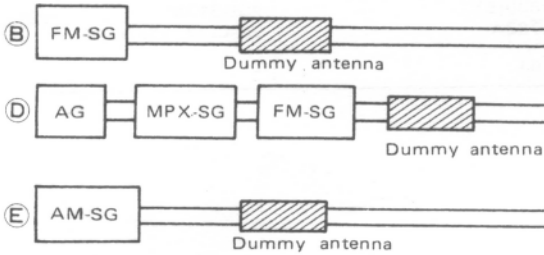
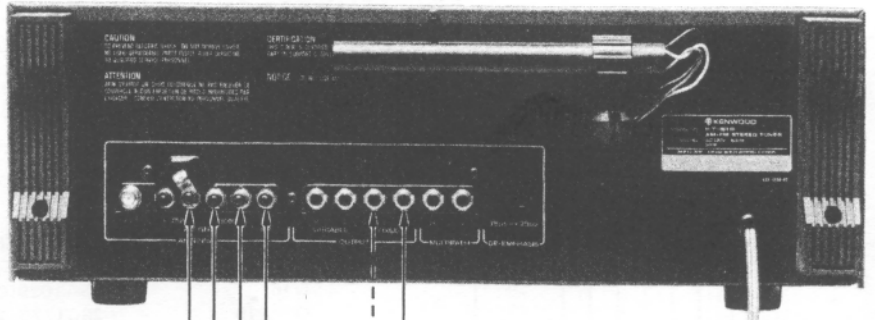
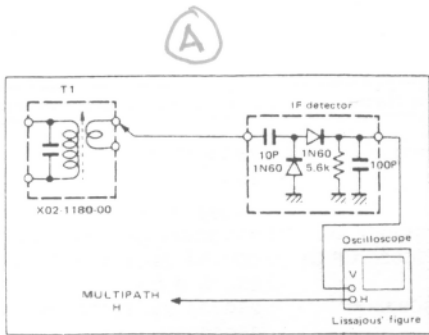

PC BOARD

RF (X05-1660-10, -11) COMPONENT SIDE

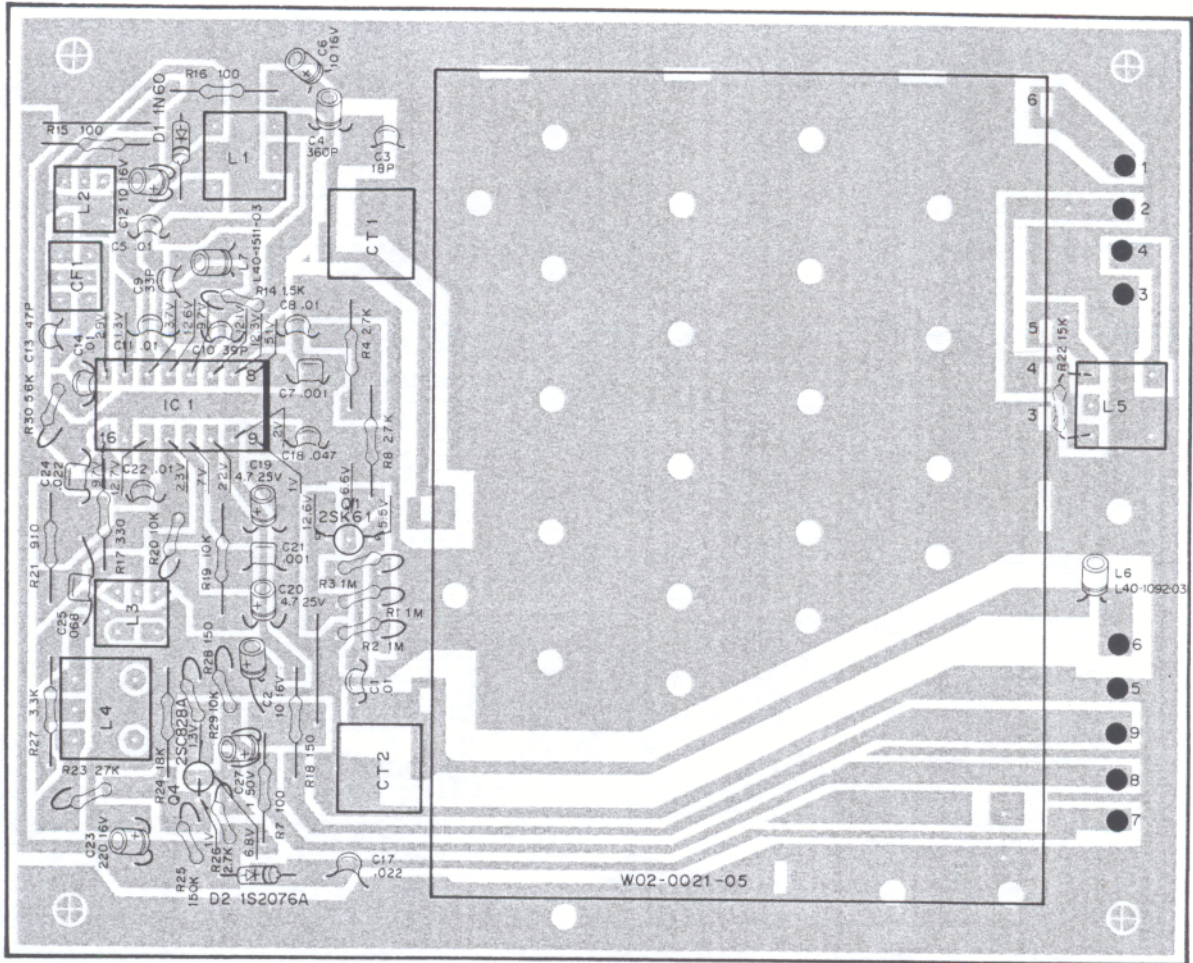

FRONT END (W02-0021-05) COMPONENT SIDE

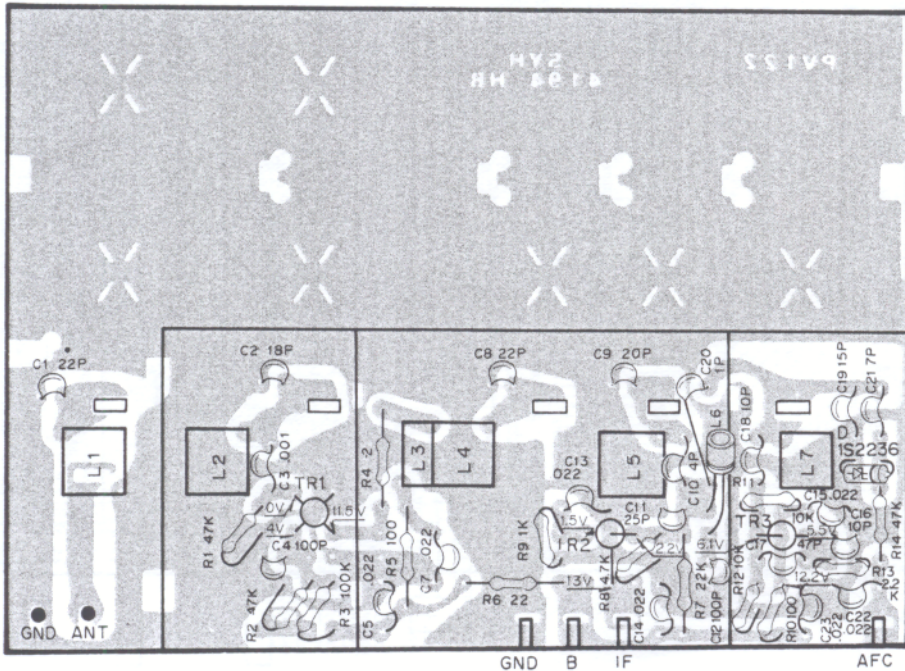

GND ANT

TR 1 : 3SK85B

TR 2 : 2SC535(C)

TR 3 : 2SC461(C)

WAVEFORMS AT CHECKPOINTS

- ① ~ ⑰: FM 95 MHz, 1 kHz Mod, ± 75 kHz Dev, 60 dB (ANT INPUT)
- ⑱ ~ ⑳: FM 95 MHz, 1 kHz Mod, ± 68.25 kHz Dev, SELECTOR: L+R 60 dB (ANT INPUT)
- ㉔ ~ ㉚: AM 1000 kHz, 1 kHz, 20% Mod

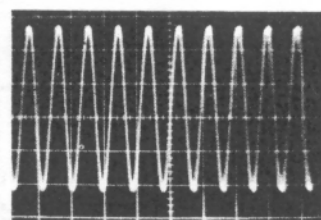
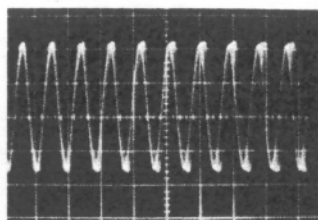
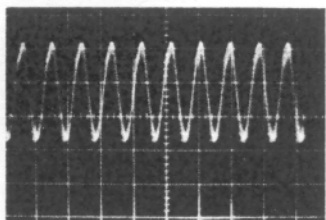
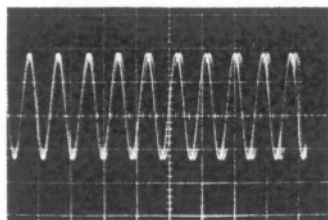

① .1 μ S/cm, 20mV/cm

② .1 μ S/cm, .1V

③ .1 μ S/cm, 200mV/cm

④ .1 μ S/cm, 20mV/cm

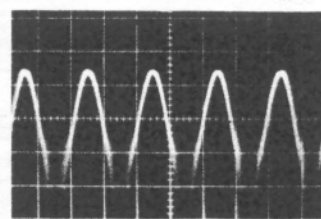
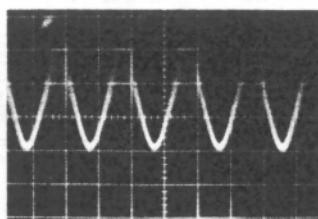
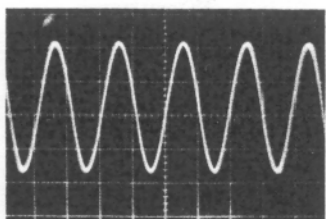
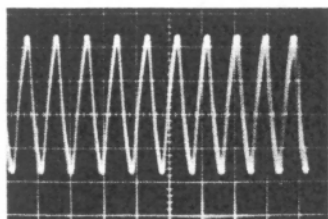

⑤ .1 μ S/cm, 20mV/cm

⑥ at de-tune .5mS/cm, .2V/cm

⑦ Dial pointer position: Slightly higher than the signal frequency. .5mS/cm, .2V/cm

⑧ Dial pointer position: Slightly lower than the signal frequency. .5mS/cm, .2V/cm

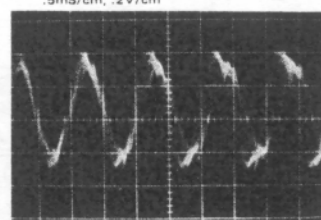
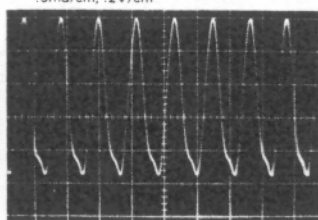
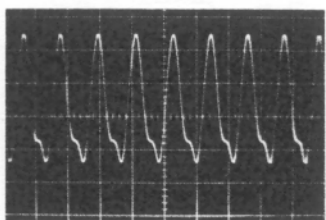
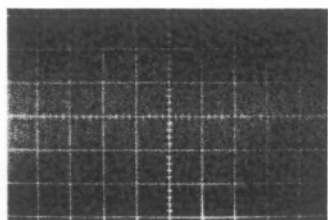

⑨ at de-tune .5m μ S/cm, .2V/cm

⑩ .1 μ S/cm, 50mV/cm

⑪ .1 μ S/cm, 50mV/cm

⑫ .2 μ S/cm, .2V/cm

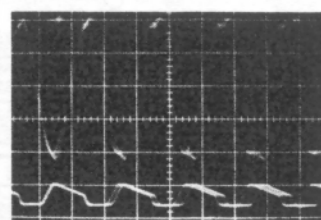
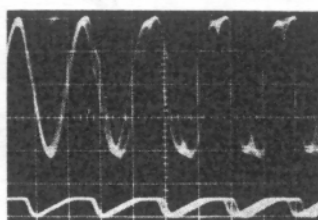
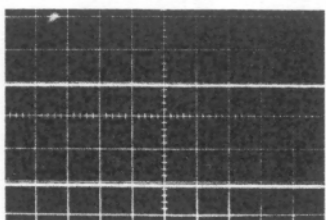
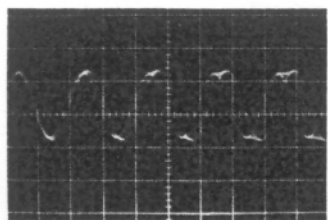

⑬ .2 μ S/cm, .2V/cm

⑭ GND line of ⑬ and ⑮

⑭ Top: FL2 output .2 μ S/cm, .1V/cm
Bottom: ICB-9 2 μ S/cm, 10V/cm

⑮ Top: FL2 output .1 μ S/cm, .1V/cm
Bottom: ICB-10 .1 μ S/cm, 2V/cm

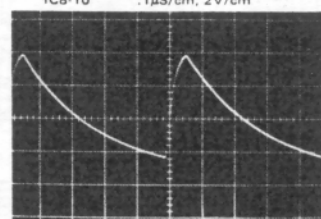
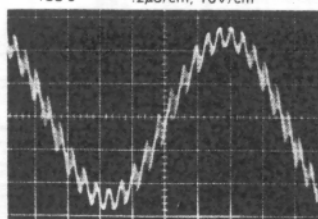
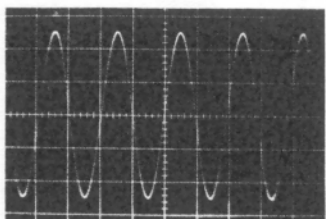
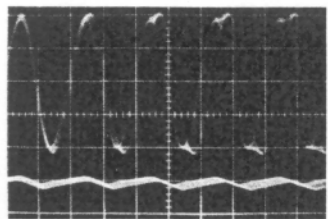

⑯ Top: FL2 output .2 μ S/cm, .1V/cm
Bottom: ICB-8 (center line -4V) 2 μ S/cm, 2V/cm

⑰ .5mS/cm, 50mV/cm (AC)

⑱ .5mS/cm, .2V/cm

⑲ 2 μ S/cm, 1V/cm

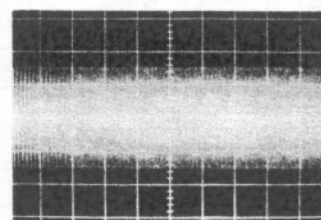
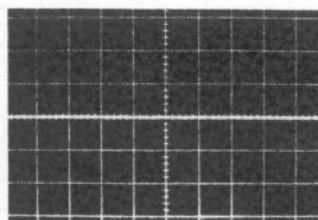
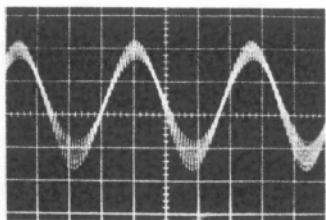
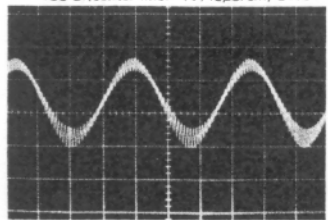

⑳ .2mS/cm, .2V/cm

㉑ .2mS/cm, 2V/cm

㉒ Q3-C (at tune) 50 μ S/cm, 2V(AC)/cm

㉒ Q3-C (at de-tune) 50 μ S/cm, 2V(AC)/cm

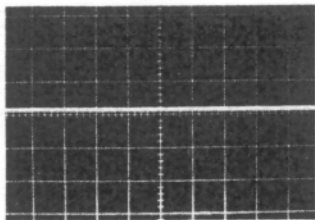

22 Q4-B at tune
1mS/cm, 1V(DC)/cm

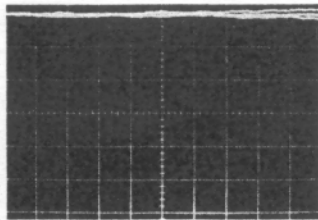

23 Q4-B at de-tune
1mS/cm, 1V(DC)/cm

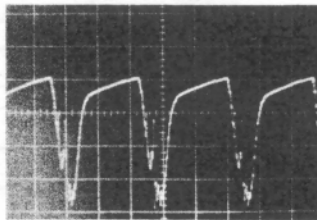

24 Q17-B (touch)
5mS/cm
50mV/cm

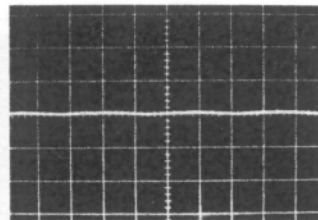

24 Q17-B (non-touch)
5mS/cm
20mV/cm

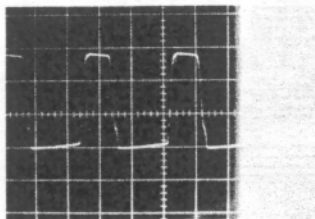

25 Q17-C (touch)
5mS/cm
2V/cm

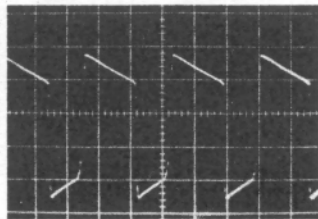

26 IC9-3 (touch)
5mS/cm
2V/cm

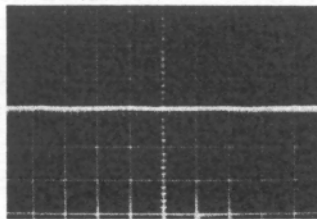

27 IC9-5 (touch)
5mS/cm
2V/cm

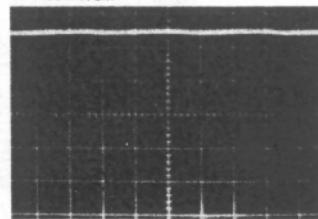

27 IC9-5 (non-touch)
5mS/cm
2V/cm

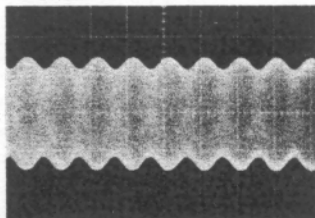

28 1mS/cm, 20mV/cm

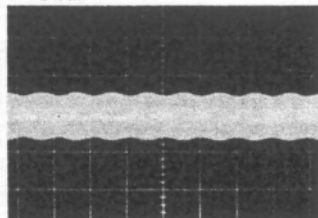

29 1mS/cm, 10mV/cm

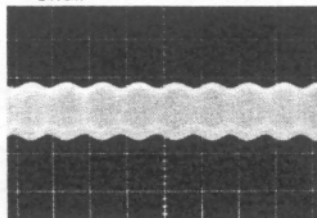

30 1mS/cm, 10mV/cm

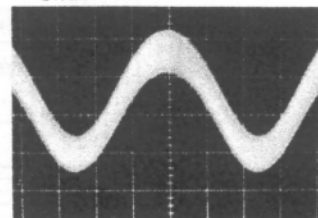

31 .2mS/cm, 10mV/cm

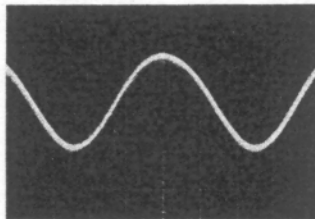

32 .2mS/cm, 10mV/cm

PARTS LIST

See instructions at the end of this parts list.

Ref. No.	Parts No.	Description	Re- marks	Ref. No.	Parts No.	Description	Re- marks
参照番号	部品番号	部品名 / 規格	備考	参照番号	部品番号	部品名 / 規格	備考
KT-815 (UNIT)							
1	2B	-		32	1A	E05-0125-05	PLUG F TYPE
2	1B	-		33	1B	E30-0181-05	POWER CORD
3	2B	-		33	1B	E30-0185-05	POWER CORD
4	3A	-		33	1B	E30-0459-05	POWER CORD
5	1B	-		33	1B	E30-0545-05	POWER CORD
6	2B	-		33	1B	E30-0602-05	POWER CORD
7	1A	-		34	1B	E30-0505-05	AUDIO CORD
8	2B	-		35	3B	E40-0826-05	PIN CONNECTOR 3P
9	3A	-		36	1B	G01-0314-04	COIL SPRING
10	3B	-		37	1B	G13-0121-03	CUSHION
11	2A	-		-		H01-1890-04	CARTON BOX
12	3B	-		-		H01-1890-04	CARTON BOX
				-		H01-1890-04	CARTON BOX
				-		H01-1891-04	CARTON BOX
				-		H01-1892-04	CARTON BOX
	351-0008-04	DIAL CORD		-		H01-1893-04	CARTON BOX
13	1A	A01-0349-13		-		H10-1524-22	POLYSTYRENE FIXTURE X2
14	3A	A20-1390-13	*K	-		H20-0448-04	COVER
14	3A	A20-1390-13	PU	-		H20-0453-04	COVER
14	3A	A20-1390-13	MH	-		H20-0453-04	COVER
14	3A	A20-1390-13	XE	-		H20-0453-04	COVER
14	3A	A20-1391-13	*H	-		H20-0453-04	COVER
14	3A	A20-1417-13	*T	-		H20-0453-04	COVER
15	3A	A21-0302-03	*K	-		H20-0453-04	COVER
15	3A	A21-0302-03	PU	-		H25-0078-04	BAG 235X315
15	3A	A21-0302-03	MX	-		H25-0096-04	BAG 80X120
15	3A	A21-0302-03	ET	-		H25-0148-04	BAG 110X230
15	3A	A21-0303-03	*H	-			
16	3B	A30-0156-03		-		J02-0097-04	FOOT
				38	2B	J02-0049-14	FOOT X4
	B46-0055-20	WARRANTY CARD	P	38	2B	J02-0049-14	FOOT X4
	B46-0060-00	WARRANTY CARD	T	38	2B	J02-0049-14	FOOT X4
	B46-0061-20	WARRANTY CARD	K	38	2B	J02-0049-14	FOOT X4
	B46-0062-20	WARRANTY CARD	UH	38	2B	J02-0049-14	FOOT X4
	B46-0063-00	WARRANTY CARD	U	38	2B	J02-0073-04	FOOT X4
				39	1B	J19-0507-05	HOLDER ANTENNA
	B46-0064-00	WARRANTY CARD	X	40	1B	J41-0024-15	BUSHING POWER CORD
	B50-1830-00	INSTRUCTION MANUAL	*K	40	1B	J41-0033-05	BUSHING POWER CORD
	B50-1830-00	INSTRUCTION MANUAL	U	40	1B	J41-0034-05	BUSHING POWER CORD
	B50-1831-00	INSTRUCTION MANUAL	*P	40	1B	J41-0034-05	BUSHING POWER CORD
	B50-1831-00	INSTRUCTION MANUAL	MX	40	1B	J41-0034-05	BUSHING POWER CORD
	B50-1832-00	INSTRUCTION MANUAL	*H	41	3A	K21-0366-04	KNOB TUNING
	B50-1834-00	INSTRUCTION MANUAL	*T	42	3A	K21-0367-04	KNOB OUTPUT LEVEL
17	2A, 3B	B01-0124-04		43	3A	K27-0076-04	KNOB POWER
18	3A	B01-0127-02		44	2A	K27-0077-04	KNOB POWER
19	3A	B07-0252-04		45	2B	K27-0082-04	KNOB ST. MUT. SEL
20	3A	B10-0241-04		46	1A	K27-0083-04	KNOB MPX. MODE
21	2B	B19-0203-03		47	2B	L01-1711-05	POWER TRANSFORMER
22	3A	B20-0441-04	*	47	2B	L01-1711-05	POWER TRANSFORMER
23	3A	B21-0030-04		47	2B	L01-1714-05	POWER TRANSFORMER
24	3B	B30-0160-05		47	2B	L01-1714-05	POWER TRANSFORMER
25	2A, 3B	B30-0166-05		47	2B	L01-1714-05	POWER TRANSFORMER
26	3B	B30-0171-05		47	2B	L01-1717-05	POWER TRANSFORMER
27	3B	B31-0298-05	*	47	2B	L01-1717-05	POWER TRANSFORMER
C1	C2	C54-3310-39	ET	48	1A	N08-0125-05	DRESSED SCREW M4X8
C1		C90-0145-05	K	49	2A	N09-0293-05	SCREW PULLEY
C1		C91-0023-05	UM	R1		R92-0173-05	RC 2. 2M 2H
C1		C91-0023-05	HX	50	1B	S31-2050-05	SLIDE SWITCH
C1		C91-0025-05	P	50	1B	S31-2050-05	SLIDE SWITCH
28	1B	D15-0155-13		50	1B	S31-2050-05	SLIDE SWITCH
29	1B	D15-0156-13		51	2A	S33-1011-05	LEVER SWITCH POWER
30	2A	D15-0170-14		51	2A	S33-1011-05	LEVER SWITCH POWER
31	2A	D20-0144-03		51	2A	S33-1011-05	LEVER SWITCH POWER

PARTS LIST

Ref. No. 参照番号	Parts No. 部品番号	Description 部品名 / 规格	Re- marks 備考	Ref. No. 参照番号	Parts No. 部品番号	Description 部品名 / 规格	Re- marks 備考
51	2A	S33-1015-05		C65	C58-1747-05	CERAMIC 47PF J	
51	2A	S33-2042-05	LEVER SWITCH POWER	C66	C91-0070-05	CERAMIC 0.047UF Z	
52	1B	T90-0096-05	LEVER SWITCH POWER	C69	C24-1010-71	ELECTRO 100UF 10WV	
53	1B	T90-0202-05	ANTENNA AM	C70	C24-1210-61	ELECTRO 10UF 16WV	
54	2B	X02-1180-10	ANTENNA FM	C71	C24-1047-61	ELECTRO 47UF 10WV	
54	2B	X02-1180-10	IF PCB ASSY	*K	C72	C52-1727-16	CERAMIC 270PF K
54	2B	X02-1182-71	IF PCB ASSY	P	C73	C24-1447-51	ELECTRO 4.7UF 25WV
54	2B	X02-1182-71	IF PCB ASSY	XE	C74	C24-1733-51	ELECTRO 3.3UF 50WV
54	2B	X02-1182-81	IF PCB ASSY	T	C75	C45-1747-36	MYLAR 0.047UF K
54	2B	X02-1182-81	IF PCB ASSY	UM	C76	C46-1722-26	MYLAR 0.0022UF K
54	2B	X02-1182-81	IF PCB ASSY	H	C77	C55-1747-38	CERAMIC 0.047UF Z
55	1B	X05-1660-10	RF/AM PCB ASSY	*U	C78	C24-1222-71	ELECTRO 220UF 16WV
55	1B	X05-1660-10	RF/AM PCB ASSY	HX	C79	C46-1715-26	MYLAR 0.0015UF K
55	1B	X05-1660-10	RF/AM PCB ASSY	ET	C80	C46-1715-34	MYLAR 0.015UF G
55	1B	X05-1660-10	RF/AM PCB ASSY	M	C80	C46-1775-24	MYLAR 0.0075UF G
55	1B	X05-1660-11	RF/AM PCB ASSY	KP	C80	C46-1775-24	MYLAR 0.0075UF G
IF (X02-1180)				C81	C46-1715-34	MYLAR 0.015UF G	81
C1	C55-1710-38	CERAMIC 0.01UF Z		C81	C46-1775-24	MYLAR 0.0075UF G	10
C2	C24-1210-71	ELECTRO 100UF 16WV		C81	C46-1775-24	MYLAR 0.0075UF G	10
C3	C55-1710-38	CERAMIC 0.01UF Z		C81	C46-1775-24	MYLAR 0.0075UF G	10
C15	C25-1747-47	LL-ELEC 0.47UF 50WV		C82	C46-1715-34	MYLAR 0.015UF G	81
C16	C55-1710-38	CERAMIC 0.01UF Z		C82	C46-1775-24	MYLAR 0.0075UF G	10
C17	C54-1710-29	CERAMIC 0.001UF P		C82	C46-1775-24	MYLAR 0.0075UF G	71
C18	C55-1710-38	CERAMIC 0.01UF Z		C83	C46-1715-34	MYLAR 0.015UF G	10
C22	C55-1747-38	CERAMIC 0.047UF Z		C83	C46-1775-24	MYLAR 0.0075UF G	71
C23	C55-1710-38	CERAMIC 0.01UF Z		C83	C46-1775-24	MYLAR 0.0075UF G	10
C25	C71-1710-15	CERAMIC 100PF J		C83	C46-1775-24	MYLAR 0.0075UF G	71
C26	C24-1447-51	ELECTRO 4.7UF 25WV		C84	C48-1710-25	POLYSTY 1000PF J	81
C27	C55-1747-38	CERAMIC 0.047UF Z		C85	C25-1747-47	LL-ELEC 0.47UF 50WV	
C28	C24-1247-61	ELECTRO 47UF 16WV		C86	C25-1733-57	LL-ELEC 3.3UF 50WV	
C29	C52-1756-16	CERAMIC 560PF K		C88	C24-1733-51	ELECTRO 3.3UF 50WV	
C30	C25-6522-57	LL-ELEC 2.2UF 35WV		C89	C45-1710-36	MYLAR 0.01UF K	
C31	C55-1710-38	CERAMIC 0.01UF Z		C90	C25-1722-47	LL-ELEC 0.22UF 50WV	
C32	C24-1210-61	ELECTRO 10UF 16WV		C92	C24-1247-61	ELECTRO 47UF 16WV	
C33	C55-1747-38	CERAMIC 0.047UF Z		C93	C71-1710-15	CERAMIC 100PF J	
C34	C55-1710-38	CERAMIC 0.01UF Z		C94	C71-1710-02	CERAMIC 10PF D	
C36	C24-1710-51	ELECTRO 1UF 50WV		C95, C96	C24-1210-61	ELECTRO 10UF 16WV	
C38	C24-1047-61	ELECTRO 47UF 10WV		C97	C71-1710-02	CERAMIC 10PF D	
C39	C24-1022-71	ELECTRO 220UF 10WV		C98	C71-1710-15	CERAMIC 100PF J	
C40	C24-1447-51	ELECTRO 4.7UF 25WV		C99	C24-1233-61	ELECTRO 33UF 16WV	
C41	C47-1712-15	POLYSTY 120PF J		C100, C101	C24-1733-51	ELECTRO 3.3UF 50WV	
C42	C45-1747-26	MYLAR 0.0047UF K		C102, C103	C24-1247-61	ELECTRO 47UF 16WV	
C43	C24-1447-51	ELECTRO 4.7UF 25WV		C104, C105	C24-1210-61	ELECTRO 10UF 16WV	
C44	C45-1722-36	MYLAR 0.022UF K		C106, C107	C24-1410-81	ELECTRO 1000UF 25WV	
C45	C24-1447-51	ELECTRO 4.7UF 25WV		C108	C24-1410-71	ELECTRO 100UF 25WV	
C46	C25-1747-57	LL-ELEC 4.7UF 50WV		C109	C52-1756-16	CERAMIC 560PF K	
C47	C24-1247-61	ELECTRO 47UF 16WV		C110	C24-1010-71	ELECTRO 100UF 10WV	
C48	C55-1747-38	CERAMIC 0.047UF Z		C111	C24-1210-61	ELECTRO 10UF 16WV	
C49	C24-1247-61	ELECTRO 47UF 16WV		C112, C113	C24-1210-81	ELECTRO 1000UF 16WV	
C50	C55-1710-38	CERAMIC 0.01UF Z		C114	C25-1733-57	LL-ELEC 3.3UF 50WV	
C51	C55-1747-38	CERAMIC 0.047UF Z		C115	C25-1410-67	LL-ELEC 10UF 25WV	
C53	C71-1710-15	CERAMIC 100PF J		C116	C25-6522-57	LL-ELEC 2.2UF 35WV	
C54	C71-1722-05	CERAMIC 22PF J		C117, C118	C55-1710-38	CERAMIC 0.01UF Z	
C55	C24-1233-61	ELECTRO 33UF 16WV		C119	C46-1727-36	MYLAR 0.027UF K	
C56	C24-1222-61	ELECTRO 22UF 16WV		101	E29-0112-05	TERMINAL	*
C58	C55-1710-38	CERAMIC 0.01UF Z		CF1	L79-0098-05	FILTER ASSY	*
C59	C24-1210-61	ELECTRO 10UF 16WV		FL1	L79-0099-05	FILTER LC	*
C60	C26-1710-57	NF-ELEC 1UF 50WV		FL2	L79-0100-05	FILTER LC	*
C61	C46-1710-47	MYLAR 0.1UF M		FL5	L79-0080-05	FILTER LC	*
C62	C25-1733-57	LL-ELEC 3.3UF 50WV		FL6, FL7	L79-0060-05	FILTER LOW PASS	
C63	C24-1247-61	ELECTRO 47UF 16WV		L1	L40-2292-11	CHOKE COIL 2.2UH	
C64	C24-1247-71	ELECTRO 470UF 16WV		L3	L40-6825-64	INDUCTOR 6.8MH	
				L4	L40-2292-11	CHOKE COIL 2.2UF	

PARTS LIST

Ref. No. 参照番号	Parts No. 部品番号	Description 部品名 / 規格	Re- marks 備考
T1	L30-0297-05	IFT FM	
T2	L30-0320-05	IFT QUADRATURE	
T3	L32-0218-15	FM OSC COIL	
T4	L19-0009-05	TRANSFORMER BALUN	
R3	R43-1210-15	FL-PROOF RD100 J 2E	
R10 , R11	R43-1210-15	FL-PROOF RD100 J 2E	
R15	R43-1210-15	FL-PROOF RD100 J 2E	
R26	R43-1210-15	FL-PROOF RD100 J 2E	
R28	R43-1210-15	FL-PROOF RD100 J 2E	
R42 , R43	R43-1210-15	FL-PROOF RD100 J 2E	
R49	R43-1210-15	FL-PROOF RD100 J 2E	
R104	R43-1233-05	FL-PROOF RD33 J 2E	
R105	R49-6282-23	RN 8.2K F 2E	
R108	R43-1222-05	FL-PROOF RD22 J 2E	
R118	R43-1210-15	FL-PROOF RD100 J 2E	
R126	R43-1210-15	FL-PROOF RD100 J 2E	
R135	R43-1210-15	FL-PROOF RD100 J 2E	
R141	R43-1210-15	FL-PROOF RD100 J 2E	
R157	R47-1418-15	FL-PROOF RS180 J 3A	
R165, R166	R47-1456-95	FL-PROOF RS5.6 J 3A	
R167, R168	R43-6210-05	FL-PROOF RD 10 J 2E	
R170	R43-1210-15	FL-PROOF RD100 J 2E	
VR1 , VR2	R12-0065-05	TRIMMING POT. 470(B)	
VR3	R12-1040-05	TRIMMING POT. 4.7K(B)	
VR4	R12-3046-05	TRIMMING POT. 47K(B)	
VR5	R12-1041-05	TRIMMING POT. 3.3K(B)	
VR6 -VR8	R12-5030-05	TRIMMING POT. 100K(B)	
VR9	R12-1039-05	TRIMMING POT. 2.2K(B)	
VR10	R12-8009-05	TRIMMING POT. 1M(B)	
VR11	R06-2011-05	POTENTIOMETER E16, 105	
-	S51-2037-05	REED RELAY	
S1 -S3	S42-3027-05	PUSH SWITCH E16, 102	*
S4 , S5	S42-2023-05	PUSH SWITCH E16, 103	
D1 -D3	V11-0273-05	1S2076A	
D2 -D22	V11-0076-05	1S1555, 1S2076	
D24 , D25	V11-0076-05	1S1555, 1S2076	
D26	V11-4101-50	XZ-062 ZENER	
D27	V11-0254-05	YZ-140 ZENER	
D28	V11-0076-05	1S1555, 1S2076	
D29	V11-5100-60	RB-151 50V 1.5A	
D30 , D31	V11-0076-05	1S1555, 1S2076	
D33	V11-0076-05	1S1555, 1S2076	
IC1	V30-0215-05	LA1222	
IC2	V30-0087-05	TA7060P	
IC3	V30-0133-05	HA1137W	
IC4	V30-0264-10	HA1457	
IC5	V30-0268-20	MC1496N	
IC6	V30-0297-20	TC4069UBP	
IC7	V30-0296-20	TR4010A	
IC8	V30-0266-20	HA11223W	
IC9 , IC10	V30-0264-10	HA1457	
Q1 , Q2	V03-0402-05	2SC535(B, C)	
Q3	V09-0127-10	2SK105(F, H), 2SK68(L, M)	
Q4 -Q7	V03-0270-05	2SC945(R, Q), 2SC828A(P, Q)	
Q8	V03-0405-05	2SC945(F), 2SC828A(R)	
Q9 -Q14	V03-0270-05	2SC945(R, Q), 2SC828A(P, Q)	
Q15	V03-0405-05	2SC945(P), 2SC828A(R)	
Q16	V01-1029-10	2SA1029(C)	
Q17	V09-0127-10	2SK105(F, H), 2SK68(L, M)	
Q18 , Q19	V03-1775-00	2SC1980(T, U), 2SC1775	
Q20	V04-0330-40	2SD330(E)	

Ref. No. 参照番号	Parts No. 部品番号	Description 部品名 / 規格	Re- marks 備考
Q21 , Q22	V03-0270-05	^{Vect Q26} 2SC945(R, Q), 2SC828A(P, Q)	
Q23	V01-0733-30	2SA733A(R, Q), 2SA992(F, E)	
Q26	V03-0270-05	2SC945(R, Q), 2SC828A(P, Q)	
RF/AM (X05-1660)			
CT1 , CT2	C05-0073-05	TRIMMER CAPACITOR	*
C1	C55-1710-38	CERAMIC 0.01UF Z	
C2	C24-1210-61	ELECTRO 10UF 16WV	
C3	C70-1718-05	CERAMIC 18PF J	
C4	C48-1736-15	POLYSTY 360PF J	
C5	C55-1710-38	CERAMIC 0.01UF Z	
C6	C24-1210-61	ELECTRO 10UF 16WV	
C7	C46-1710-26	MYLAR 0.001UF K	
C8	C55-1710-38	CERAMIC 0.01UF Z	
C9	C71-1733-05	CERAMIC 33PF J	
C10	C71-1739-05	CERAMIC 39PF J	
C11	C55-1710-38	CERAMIC 0.01UF Z	
C12	C24-1210-61	ELECTRO 10UF 16WV	
C13	C71-1747-05	CERAMIC 47PF J	
C14	C55-1710-38	CERAMIC 0.01UF Z	
C17	C55-1722-38	CERAMIC 0.022UF Z	
C18	C55-1747-38	CERAMIC 0.047UF Z	
C19 , C20	C24-1447-51	ELECTRO 4.7UF 25WV	
C21	C46-1710-26	MYLAR 0.001UF K	
C22	C55-1710-38	CERAMIC 0.01UF Z	
C23	C24-1222-71	ELECTRO 220UF 16WV	
C24	C46-1722-36	MYLAR 0.022UF K	
C25	C46-1768-36	MYLAR 0.068UF K	
C27	C24-1710-51	ELECTRO 1UF 50WV	
CF1	L72-0054-05	CERAMIC FILTER	
L1	L32-0205-15	OSCILLATING COIL AM	
L2	L30-0307-05	IFT AM	
L3	L30-0284-05	IFT	
L4	L72-0054-05	LC FILTER	10
L5	L30-0326-05	IFT FM	*
L6	L40-1092-03	INDUCTOR	
L7	L40-1511-03	INDUCTOR	
R7	R43-1210-15	FL-PROOF RD100 J 2E	
R15, R16	R43-1210-15	FL-PROOF RD100 J 2E	
D1	V11-0051-05	1N60	
D2	V11-0273-05	1S2076A	
IC1	V30-0196-05	HA1197	
Q1	V09-0124-20	2SK61(Y)	
Q4	V03-0345-05	2SC828A(Q, R), 2SC945(Q, P)	
104 1B	W02-0021-05	FRONT END PCB ASSY	*

FRONT END (W02-0021-05)

Ref. No.	Parts No.	Description	Re- marks
C1	C71-1722-06	Ceramic 22pF K	
C2	C71-1718-06	Ceramic 18pF K	
C3	C71-2710-25	Ceramic 0.001μF J	
C4	C71-1710-16	Ceramic 100pF K	
C5	C55-1722-38	Ceramic 0.022μF Z	
C6	C71-1702-02	Ceramic 2pF D	
C7	C55-1722-38	Ceramic 0.022μF Z	
C8	C63-1722-05	Ceramic 22pF J	
C9	C63-1720-05	Ceramic 20pF J	
C10	C71-1704-02	Ceramic 4pF D	
C11	C71-1725-06	Ceramic 25pF K	
C12	C71-1710-16	Ceramic 100pF K	
C13~15	C55-1722-38	Ceramic 0.022μF Z	
C16	C63-1710-05	Ceramic 10pF J	
C17	C63-1747-05	Ceramic 47pF J	
C18	C66-1710-02	Ceramic 10pF D	
C19	C66-1715-02	Ceramic 15pF D	
C20	C71-1701-02	Ceramic 1pF D	
C21	C63-1707-02	Ceramic 7pF D	
C22,23	C55-1722-38	Ceramic 22pF Z	
TR1	V09-0150-10	3SK85	
TR2	V03-0065-05	2SC535	
TR3	V03-0170-05	2SC461	
D	V11-3100-50	1S2236	

Ref. No.	Parts No.	Description	Re- marks
参照番号	部品番号	部品名/規格	備考
②			
①	14 3A	A20-1391-13	*H
	14 3A	A20-1417-13	*T
	15 3A	A21-0302-03	*K
	15 3A	A21-0302-03	PU
	15 3A	A21-0302-03	MX
⑤	C1, C2	C54-3310-39	ET
	C1	C90-0145-05	K
	C1	C91-0023-05	UM
	C1	C91-0023-05	HX
	C1	C91-0025-05	P
	28 1B	D15-0155-13	
	29 1B	D15-0156-13	
	30 2A	D15-0170-14	
	31 2A	D20-0144-03	
			⑥

- ① Exploded view drawing No.
- ② Position in exploded view.
- ③ Symbol of new parts.
- ④ Area to which parts are shipped. Example: A20-1390-13 is the part No. of FRONT PANEL ASS'Y for the "K" type products (for USA).
When this column is blank, it means that the same type of parts (same parts No.) are used for the products shipped to all areas.
- ⑤ Reference No. in schematic diagram.
- ⑥ Abbreviation of "ceramic capacitor".
All capacitors and resistors are listed using abbreviations.
- ⑦ Abbreviations

* Abbreviations of capacitors (Parts No. with initial letter "C")
 ELECTRO Electrolytic capacitor
 LL-ELEC. Low leak electrolytic capacitor

NP-ELEC. Non-pole electrolytic capacitor
 MICA Mica capacitor
 POLYSTY Polystyrene capacitor
 MYLAR Mylar capacitor
 CERAMIC Ceramic capacitor
 TANTAL Tantalum capacitor
 MF Metallized film capacitor
 OIL Oil capacitor
 The unit "UF" is used in lieu of "μF"

* Abbreviations of resistors (Parts No. with initial letters "R")
 RC Carbon composition resistor
 RD Carbon film resistor
 FL-PROOF RD Flame-proof carbon film resistor
 RW Wire wound power resistor
 FL-PROOF RS Flame-proof metal oxide film resistor
 RN Metal film resistor

2B Rated wattage 1/8W
 2E Rated wattage 1/4W
 2H Rated wattage 1/2W
 3A Rated wattage 1W
 3D Rated wattage 2W
 3F Rated wattage 3W
 3G Rated wattage 4W
 3H Rated wattage 5W

All resistor values are indicated with the unit (Ω) omitted.

* Abbreviations common to capacitors and resistors
 C ±0.25pF (Used for capacitors only)
 D ±0.5pF (Used for capacitors only)
 F ±1%
 G ±2%
 J ±5%
 K ±10%
 M ±20%
 Z +80%, -20% (Used for capacitors only)
 P +100%, -0% (Used for capacitors only)

⑧ Resistors RD (carbon composition resistors) are not listed in the parts list. For values, refer to the schematic diagram.

A product of TRIO-KENWOOD CORPORATION

6-17, 3-chome, Aobadai, Meguro-ku, Tokyo 153, Japan

KENWOOD ELECTRONICS, INC.

1315 E. Watsoncenter Rd, Carson, California 90745
 75 Seaview Drive, Secaucus, New Jersey 07094, U.S.A.

TRIO-KENWOOD ELECTRONICS, N.V.

Leuvensesteenweg 184 B-1930 Zaventem, Belgium

TRIO-KENWOOD ELECTRONICS GmbH

Rudolf-Braas-Str. 20, 6056 Heusenstamm, West Germany

TRIO-KENWOOD FRANCE S.A.

5, Boulevard Ney, 75018 Paris, France

TRIO-KENWOOD SVENSKA AB

Kemistvagen 10A, S-183 21 Taby, Sweden

TRIO-KENWOOD (AUSTRALIA) PTY. LTD.

30 Whiting St., Artarmon, N.S.W. 2064, Australia

KENWOOD & LEE ELECTRONICS, LTD.

Room 501, Wang Kee Building, 5th Floor, 34-37, Connaught Road, Central, Hong Kong