

# KENWOOD

# KT-770 KT-770/L

## QUARTZ SYNTHESIZER TUNER

# SERVICE MANUAL

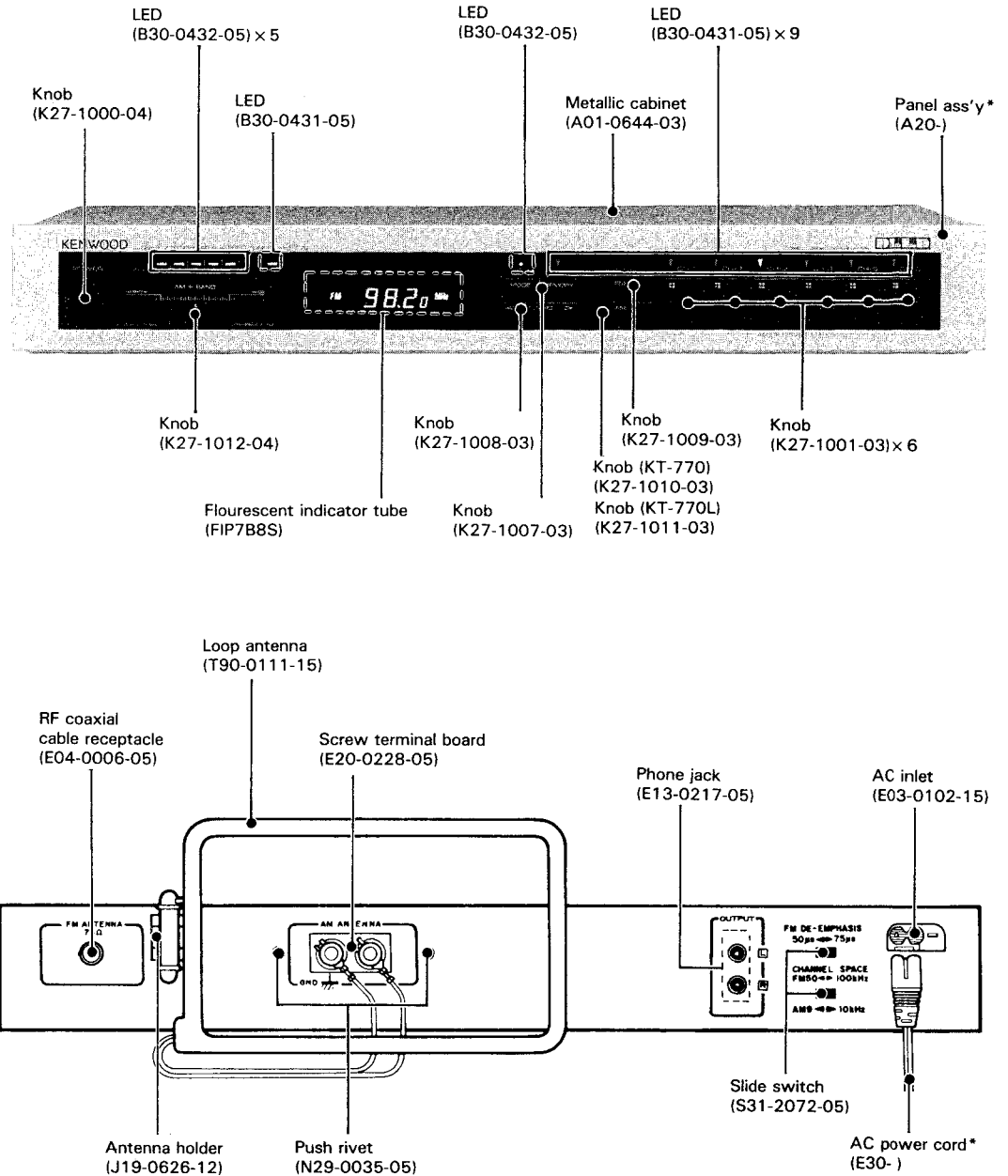

Photo is KT-770.

\*Refer to Parts List on page 17.

411

## BLK DIAGRAM/CIRCUIT DESCRIPTION

### BLOCK DIAGRAM

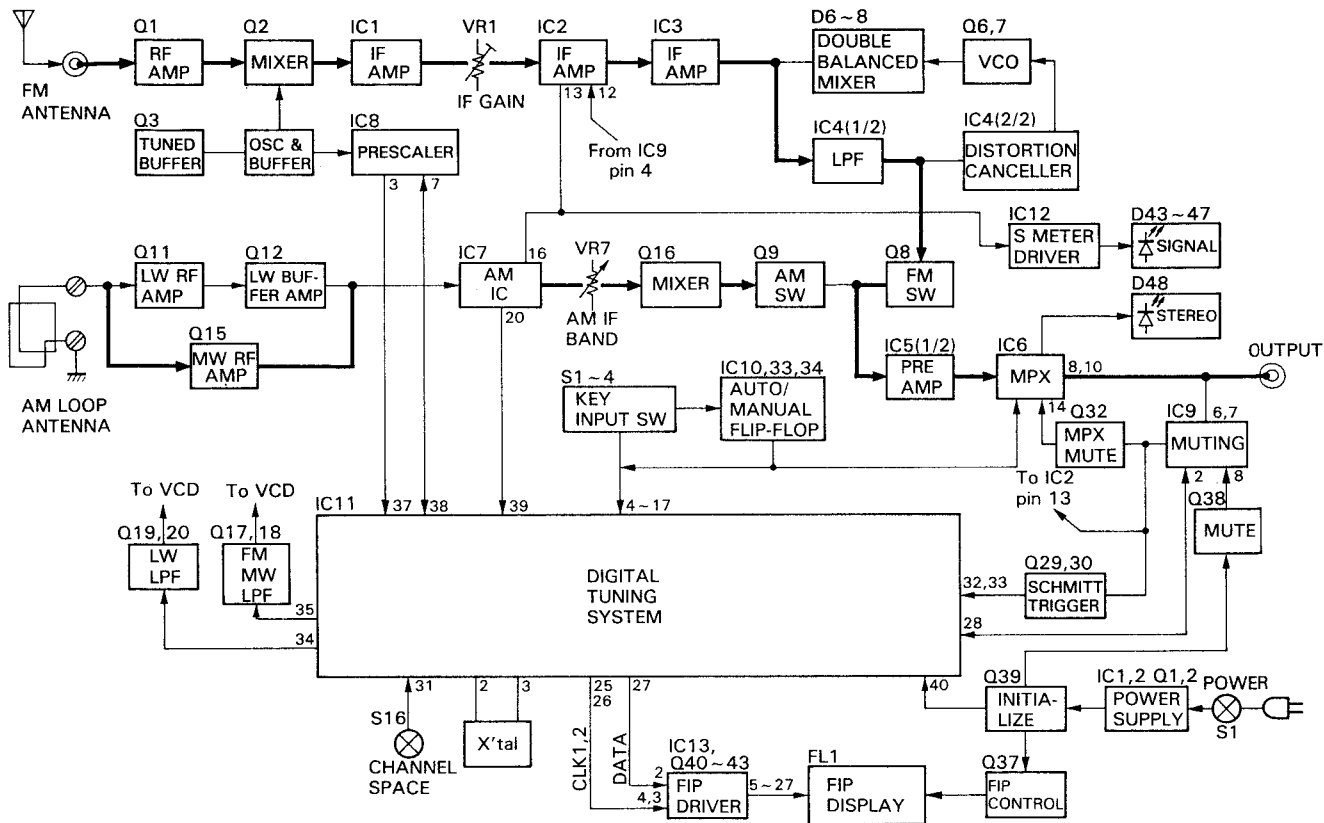

### CIRCUIT DESCRIPTION

#### 1. Direct Linear Loop Detector (DLLD)

This DLLD circuit is an advanced Phased Locked Loop (PLL) detector. First, a brief explanation of a PLL detector is written below. Block diagram of PLL detector is shown in Fig. 1.

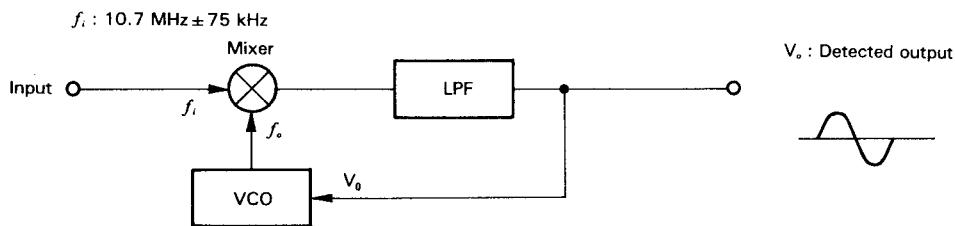

Fig. 1 Block diagram of PLL detector

PLL detector is a closed circuit containing a mixer, LPF, VCO. This closed circuit is designed so that the phase of the oscillator frequency  $f_o$  (output of VCO) coincide with the input frequency  $f_i$ . The input frequency  $f_i$  changes between  $10.7 \text{ MHz} \pm 75 \text{ kHz}$  every moment and the oscillator frequency  $f_o$  also changes to coincide to the phase of the input frequency  $f_i$ . If the phase coincides, the frequency also coincides, meaning the same waveform is obtained at the output of VCO ( $f_o$ ). The relationship between the voltage applied to the VCO circuit ( $V_o$ ) and the output frequency  $f_o$  is shown in Fig. 2. From this diagram, you will know that if the characteristic curve is linear, the waveform of  $f_o$  will be similar

to the waveform of  $V_o$ . Since  $f_i$  and  $f_o$  is equal in a PLL circuit,  $f_i$  and  $V_o$  will be a similar waveform. Hence, the frequency variation will be converted to a voltage variation. This is the detected output. In a normal PLL detector, linear relationship between  $f_o$  and  $V_o$  can not be obtained. The dotted line in Fig. 2 shows the actual non-linear relationship which is the cause of the distortion. The reason of this non-linearity is the relationship between the applied voltage and the capacitance of the variable capacitance diode.

In this DLLD circuit, we added a circuit having an anti-phase characteristic curve to compensate the non-linearity. Detailed explanation is written in the following.

CIRCUIT DESCRIPTION

Block diagram of DLLD circuit is shown in Fig. 3. The Signal-to-Noise (S/N) ratio depends on the performance of the phase detector and the VCO. In the DLLD circuit, balanced-type phase detector using 4 diodes and tuned-type VCO using variable capacitance diodes and a coil to improve the S/N ratio. Also by adding a compensating circuit for the non-linearity of the variable capacitance diode, the DLLD circuit improved both the S/N and the linearity. The actual circuit of the phase detector and the voltage controlled oscillator is shown in Fig. 4 and 5.

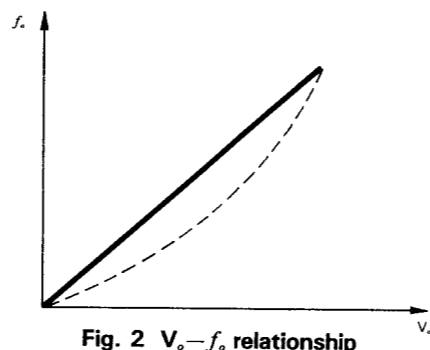

Fig. 2  $V_c - f_o$  relationship

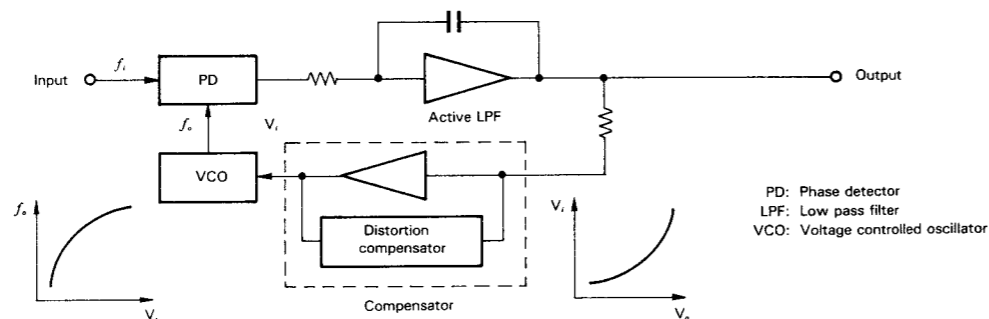

Fig. 3 Block diagram of DLLD circuit

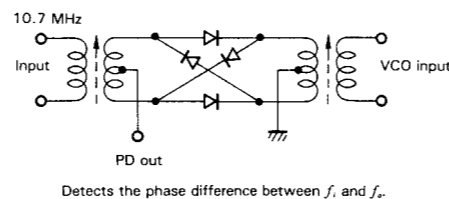

Fig. 4

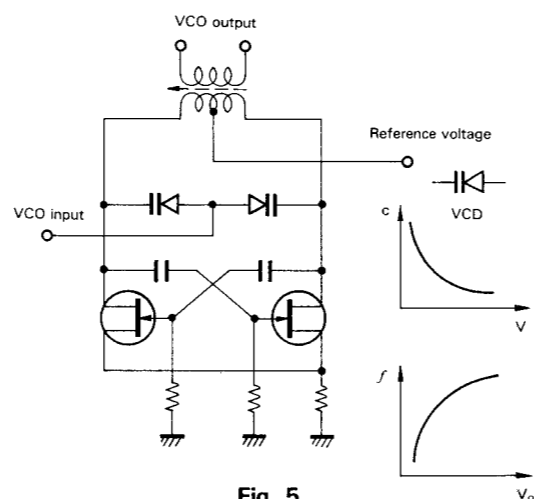

Fig. 5

The actual circuit of the distortion compensator is shown in Fig. 6. The circuitry surrounded by the dotted line, consisting of two diodes and resistors, does this job. The distortion generated from the PLL detector is mainly due to the non-linearity of the Voltage-to-Frequency characteristic of the VCO.

Most of this distortion is the second harmonic distortion. This distortion varies according to the various characteristic curves of voltage-to-capacitance of the variable capacitance diode in the VCO circuit. The distortion compensator is employed to absorb this various voltage-to-capacitance characteristics.

Trimming potentiometer VR1 is adjusted so that when the distortion of the VCO is an in-phase component to the basic wave, the amplitude of the demodulated signal is applied more to either one of the D1 or D2 and when it is an anti-phase component to the basic wave, the amplitude of the demodulated signal is applied more to the other diode.

This means that the distortion compensator generates the anti-phase distortion to cancel the distortion generated by the variable capacitance diode, enabling to obtain a distortion free demodulated signal at the output.

This is how this DLLD circuit contribute to improve S/N ratio and total harmonic distortion to 104 dB or more and 0.001% or less respectively.

CIRCUIT DESCRIPTION

Semiconductor	Usage	Description
IC1	FM IF Amp	
IC2	FM IF System	IF amp, S-meter driver, Muting signal (Stop signal) output
IC3	FM IF Amp	Works as a buffer and an amplifier between IC2 and the double balanced mixer.
IC4	PLL Detector	LPF, Detected output adjustment and distortion canceller circuit.
IC5	MPX Preamp	IC5 (1/2) Amplification of FM detected output or AM demodulated output.
IC6	MPX	Stereo demodulation, Muting, VCO stop (AM), Forced MONO.
IC7	AM	RF Vcc is cut in FM mode. S meter output is used as NARROW demodulated output.
IC8	FM Prescaler	Divides FM OSC frequency.
IC9	Muting	Output grounding type. CPU mute, Power ON/OFF mute, FM IF mute, AM S-meter mute.
IC10	AUTO STEREO/MANUAL MONO SW	T-type flip-flop. The state is maintained when POWER is turned OFF by C124 and 125.
IC11	Digital Tuning System	Programmable counter for FM, AM (MW), LW. Station memory, Reference oscillator (7.2 MHz), Phase comparator, Display driver etc.
IC12	S-meter Driver	LED ID $\approx$ 15 mA
IC13	FIP Driver	
Q1	FM RF Amp	
Q2	FM Mixer	
Q3	Buffer Amp	Buffer amp between the oscillator and the mixer amp.
Q4	FM OSC	
Q5	Buffer amp	Buffer amp between the oscillator and the prescaler.
Q6, 7	Oscillator (10.7 MHz)	10.7 MHz VCO for PLL detector.
Q8	FET SW	ON when FM is selected.
Q9	FET SW	On when AM (MW, LW) is selected.
Q10	MONO SW	Switches the mode to MONO by detecting the S-meter level.
Q11	LW RF Amp	
12	LW Buffer Amp	
Q13	FET SW	ON when LW is selected.
Q14	FET SW	ON when MW is selected.
Q15	MW RF Amp	

Semiconductor	Usage	Description
Q16	Mixer	When AM is selected, WIDE and NARROW output is mixed.
Q17, 18	FM MW LPF	LPF for variable capacitance diode of FM, MW circuit.
Q19, 20	LW LPF	LPF for variable capacitance diode of LW circuit.
Q21	LW SW	When LW is selected, feeds power to LW circuit.
Q22	LW Control	
Q23	MW SW	When MW is selected, feeds power to LW circuit.
Q24	MW Control	
Q25	FM SW	When FM is selected, feeds power to FM circuit.
Q26	FM Control	
Q27, 28	Muting Control	ON when power is turned ON and MUTE signal of IC11 is "H".
Q29, 30	Schmitt Trigger	AM S-meter output is input to Q29. AM S-meter output is output and FM S-meter output is input to Q30.
Q31	SW	ON when MUTE signal of IC11 is "H" when power is turned ON, when IF mute signal is "H", when S-meter is "L".
Q32	SW	Same as Q31. For MPX muting signal.
Q33, 34	Current Buffer	Current buffer and current outflow prevention when backed up by the battery.
Q35	LED driver	LW LED driver.
Q36	7.2 MHz OSC	When LW is selected, this OSC is activated to feed to the reference frequency in IC11 to adjust the center frequency of IF.
Q37	Display Control	FIP display control. When power is turned off, Q37 is ON.
Q38	Muting Control	ON when power is turned OFF and muting signal from IC9 is "L".
Q39	INH Control	Reset signal for IC11. The pulse rises or falls at power ON or OFF.
Q40	FIP Driver	For display of 5 at 10 kHz digit.
Q41	FIP Driver	For display of 0 at 10 kHz digit.
Q42	FIP Driver	For AM, kHz display on FIP.
Q43	FIP Driver	For FM, MHz display on FIP.

## SYSTEM CONNECTIONS

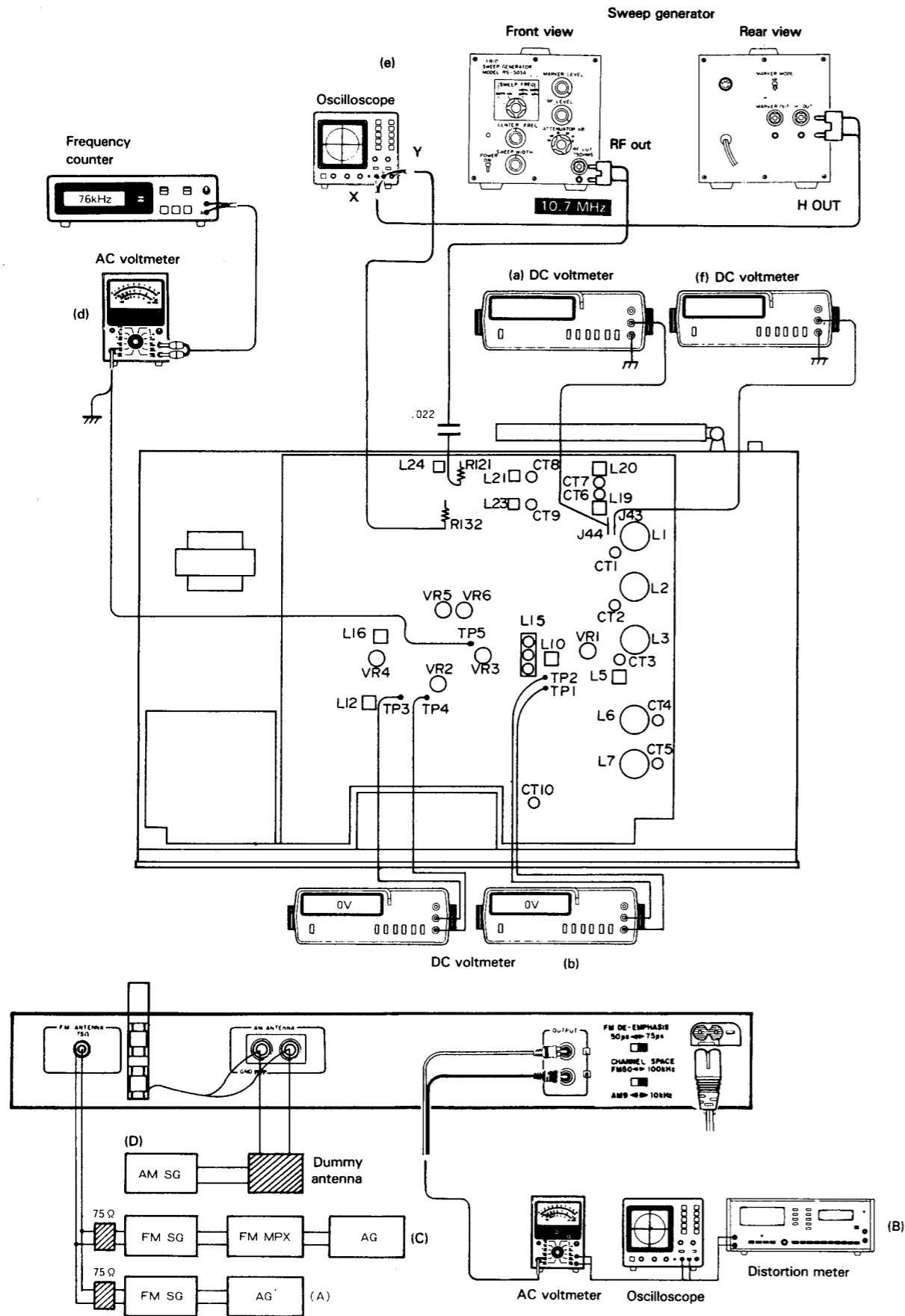

## ADJUSTMENT

**ADJUSTMENT (KT-770)** For adjustments of KT-770L, refer to P.9.

NO.	ITEM	INPUT SETTINGS	OUTPUT SETTINGS	TUNER SETTING	ALIGNMENT POINTS	ALIGN FOR	FIG.
<b>FM SECTION (KT-770)</b> Unless otherwise specified, the individual switches should be set as follows: SELECTOR: FM MODE: AUTO							
1	<b>BAND EDGE (1)</b>	—	Connect a DC voltmeter to J44.	87.5 MHz	L7	7.5 V	(a)
2	<b>BAND EDGE (2)</b>	—	Connect a DC voltmeter to J44.	108.0 MHz	CT5	23.0 V	(a)
Repeat alignments 1 and 2 several times.							
3	<b>DETECTOR (1)</b>	(A) 98.0 MHz 0 dev 100 dB (ANT input)	Connect a DC voltmeter between TP1 and 2.	98.0 MHz	L10	Confirm that voltage changes to both + and - direction. Then adjust to 0 V.	(b)
4	<b>DETECTOR (2)</b>	(A) 98.0 MHz 0 dev 100 dB (ANT input)	Connect a DC voltmeter between TP3 and 4.	98.0 MHz	L12	Confirm that voltage changes to both + and - direction. Then adjust to 0 V.	(c)
5	<b>RF ALIGNMENT (1)</b>	(A) 90.0 MHz 1 kHz, ±75 kHz dev 60 dB (ANT input)	(B)	MODE: MONO 90.0 MHz	L1, 2, 3, 6	Maximum amplitude and symmetry of the oscilloscope display.	
6	<b>RF ALIGNMENT (2)</b>	(A) 106.0 MHz 1 kHz, ±75 kHz dev 60 dB (ANT input)	(B)	MODE: MONO 106.0 MHz	CT1, 2, 3, 4	Maximum amplitude and symmetry of the oscilloscope display.	
Repeat alignments 5 and 6 several times.							
7	<b>IF GAIN</b>	(A) 98.0 MHz 0 dev 4 dB (ANT input)	—	98.0 MHz	VR1	Adjust VR1 so that SIGNAL LED goes off. Then, adjust VR1 and stop at the point where LED "1" goes on.	
8	<b>VCO</b>	(A) 98.0 MHz 0 dev 60 dB (ANT input)	Connect a frequency counter to TP5 via an AC voltmeter.	98.0 MHz	VR3	76.00 KHz	(d)
9	<b>PILOT CANCELLER (1)</b>	(C) 98.0 MHz 0 dev Selector: L or R Pilot: ±6.75 kHz dev 60 dB (ANT input)	(B)	98.0 MHz	VR4	Minimum 19 kHz output.	
10	<b>PILOT CANCELLER (2)</b>	(C) 98.0 MHz 0 dev Selector: L or R Pilot: ±6.75 kHz dev 60 dB (ANT input)	(B)	98.0 MHz	L16	Same output (L, R)	
Repeat alignments 9 and 10 several times.							
11	<b>DISTORTION (STEREO) (1)</b>	(C) 98.0 MHz 1 kHz, ±68.25 kHz dev Selector: L or R Pilot: ±6.75 kHz dev 80 dB (ANT input)	(B)	98.0 MHz	VR2	Minimum distortion.	
12	<b>DISTORTION (STEREO) (2)</b>	(C) 98.0 MHz 1 kHz, ±68.25 kHz dev Selector: L Pilot: ±6.75 kHz dev 80 dB (ANT input)	(B)	98.0 MHz	L5	Minimum distortion.	
13	<b>SEPARATION (1)</b>	(C) 98.0 MHz 1 kHz, ±68.25 kHz dev Selector: L Pilot: ±6.75 kHz dev 80 dB (ANT input)	(B)	98.0 MHz	VR6 (L)	Minimum crosstalk.	
14	<b>SEPARATION (2)</b>	(C) 98.0 MHz 10 kHz, ±68.25 kHz dev Selector: L Pilot: ±6.75 kHz dev 80 dB (ANT input)	(B)	98.0 MHz	L15 (Yellow core only)	Minimum crosstalk.	
Repeat alignments 13 and 14 several times.							

## ADJUSTMENT/REGLAGE

NO.	ITEM	INPUT SETTINGS	OUTPUT SETTINGS	TUNER SETTING	ALIGNMENT POINTS	ALIGN FOR	FIG.
15	SEPARATION (3)	(C) 98.0 MHz 1 kHz, $\pm 68.25$ kHz dev Selector: R Pilot: $\pm 6.75$ kHz dev 80 dB (ANT input)	(B)	98.0 MHz	VR5 (R)	Minimum crosstalk	
<b>AM SECTION (KT-770)</b>		Keep the AM loop antenna installed. SELECTOR: AM AM IF BAND: WIDE					
(1)	BAND EDGE (1)	—	Connect a DC voltmeter to J44.	600 kHz (603 kHz)	L23	2.5 V	(a)
(2)	BAND EDGE (2)	—	Connect a DC voltmeter to J44.	1600 kHz (1602 kHz)	CT9	20.0 V	(a)
Repeat alignments (1) and (2) several times							
(3)	RF ALIGNMENT (1)	(D) 630 kHz 400 Hz, 30% mod	(B)	AM IF BAND: NARROW 630 kHz	L19	Maximum amplitude and symmetry of the oscilloscope display.	
(4)	RF ALIGNMENT (2)	(D) 1440 kHz 400 Hz, 30% mod	(B)	AM IF BAND: NARROW 1440 kHz	CT6	Maximum amplitude and symmetry of the oscilloscope display.	
Repeat alignments (3) and (4) several times.							
(5)	IF TRANSFORMER	Sweep generator: 10.7 MHz Connect RF OUT of sweep generator to pin 5 of IC7 via 0.022 $\mu$ F capacitor.	Connect H OUT of sweep generator and H (or X) terminal of the oscilloscope. Connect V (or Y) terminal of the oscilloscope to the junction of R132 and R134.	1000 kHz (999 kHz)	L24	Maximum amplitude and symmetry of the oscilloscope display.	(e)

### REGLAGE (KT-770) Pour réglage de KT-770L, se référer à P.10.

N°	ITEM	REGLAGE DE L'ENTREE	REGLAGE DE LA SORTIE	REGLAGE DU TUNER	POINTS DE L'ALIGNEMENT	ALIGNER POUR	FIG.
<b>SECTION MF (KT-770)</b>		Sauf en cas d'indications spéciales, régler chaque commutateur comme suit: SELECTOR: FM MODE: AUTO					
1	BORD DE BANDE (1)	—	Connecter un voltmètre CC au J44.	87,5 MHz	L7	7,5 V	(a)
2	BORD DE BANDE (2)	—	Connecter un voltmètre CC au J44.	108,0 MHz	CT5	23,0 V	(a)
Répéter les alignements 1 et 2 plusieurs fois.							
3	DETECTEUR (1)	(A) 98,0 MHz 0 dév 100 dB (Entrée ANT)	Connecter un voltmètre CC entre les TP1 et 2.	98,0 MHz	L10	Affirmer que la tension change au la direction von + et -. Alors ajuster au 0 V.	(b)
4	DETECTEUR (2)	(A) 98,0 MHz 0 dév 100 dB (Entrée ANT)	Connecter un voltmètre CC entre les TP3 et 4.	98,0 MHz	L12	Affirmer que la tension change au la direction von + et -. Alors ajuster au 0 V.	(c)
5	ALIGNEMENT HT (1)	(A) 90,0 MHz 1 kHz. $\pm 75$ kHz dév 60 dB (Entrée ANT)	(B)	MODE: MONO 90,0 MHz	L1. 2. 3. 6	Amplitude et symétrie maximale de l'affichage de l'oscilloscope.	
6	ALIGNEMENT HT (2)	(A) 106,0 MHz 1 kHz. $\pm 75$ kHz dév 60 dB (Entrée ANT)	(B)	MODE: MONO 106,0 MHz	CT1. 2. 3. 4	Amplitude et symétrie maximale de l'affichage de l'oscilloscope.	
Répéter les alignements 5 et 6 plusieurs fois.							
7	FI GAIN	(A) 98,0 MHz 0 dév 4 dB (Entrée ANT)	—	98,0 MHz	VR1	Ajuster VR1 que SIGNAL LED est non allume. Alors, ajuster VR1 et arrêter le mouvement de VR1 au moment où le LED "1" s'allume.	

## REGLAGE

N°	ITEM	REGLAGE DE L'ENTREE	REGLAGE DE LA SORTIE	REGLAGE DU TUNER	POINTS DE L'ALIGNEMENT	ALIGNER POUR	FIG
8	<b>OSCILLATEUR CONTROLE PAR LA TENSION</b>	(A) 98,0 MHz 0 dév 60 dB (Entrée ANT)	Connecter un comp- teur de fréquence à TP5 par l'intermediair d'un voltmètre CA.	98,0 MHz	VR3	76,00 kHz	(d)
9	<b>CIRCUIT SUPPRESSION DE SIGNAL PILOTE (1)</b>	(C) 98,0 MHz 0 dév Selection: L ou R Signal pilote: ± 6,75 kHz dév 60 dB (Entrée ANT)	(B)	98,0 MHz	VR4	19 kHz sortie minimale.	
10	<b>CIRCUIT SUPPRESSION DE SIGNAL PILOTE (2)</b>	(C) 98,0 MHz 0 dév Selection: L ou R Signal pilote: ± 6,75 kHz dév 60 dB (Entrée ANT)	(B)	98,0 MHz	L16	Sortie même (L, R)	
Répéter les alignements 9 et 10 plusieurs fois.							
11	<b>DISTORSION (STEREO) (1)</b>	(C) 98,0 MHz 1 kHz. ± 68,25 kHz dév Selection: L ou R Signal pilote: ± 6,75 kHz dév 80 dB (Entrée ANT)	(B)	98,0 MHz	VR2	Distorsion minimale.	
12	<b>DISTORSION (STEREO) (2)</b>	(C) 98,0 MHz 1 kHz. ± 68,25 kHz dév Selection: L ou R Signal pilote: ± 6,75 kHz dév 80 dB (Entrée ANT)	(B)	98,0 MHz	L5	Distorsion minimale.	
13	<b>SEPARATION (1)</b>	(C) 98,0 MHz 1 kHz. ± 68,25 kHz dév Selection: L Signal pilote: ± 6,75 kHz dév 80 dB (Entrée ANT)	(B)	98,0 MHz	VR6 (L)	Diaphonie minimale.	
14	<b>SEPARATION (2)</b>	(C) 98,0 MHz 1 kHz. ± 68,25 kHz dév Selection: L Signal pilote: ± 6,75 kHz dév 80 dB (Entrée ANT)	(B)	98,0 MHz	L15 (Le noyau jaune seulement)	Diaphonie minimale.	
Répéter les alignements 13 et 14 plusieurs fois.							
15	<b>SEPARATION (3)</b>	(C) 98,0 MHz 1 kHz. ± 68,25 kHz dév Selection: R Signal pilote: ± 6,75 kHz dév 80 dB (Entrée ANT)	(B)	98,0 MHz	VR5 (R)	Diaphonie minimale.	
<b>SECTION MA (KT-770)</b> Laisser l'antenne boucle MA installée. SELECTOR: AM AM IF BAND: WIDE							
(1)	<b>BORD DE BANDE (1)</b>	—	Connecter un voltmètre CC au J44.	600 kHz (603 kHz)	L23	2,5 V	(a)
(2)	<b>BORD DE BANDE (2)</b>	—	Connecter un voltmètre CC au J44.	1600 kHz (1602 kHz)	CT9	20,0 V	(a)
Répéter les alignements (1) et (2) plusieurs fois.							
(3)	<b>ALIGNEMENT HT (1)</b>	(D) 630 kHz 400 Hz. 30% mod	(B)	AM IF BAND: NARROW 630 kHz	L19	Amplitude et symétrie maximale de l'affichage de l'oscilloscope.	

## REGLAGE/ABGLEICH

N°	ITEM	REGLAGE DE L'ENTREE	REGLAGE DE LA SORTIE	REGLAGE DU TUNER	POINTS DE L'ALIGNEMENT	ALIGNER POUR	FIG.
(4)	ALIGNEMENT HT (2)	(D) 1440 kHz 400 Hz. 30% mod	(B)	AM IF BAND: NARROW 1440 kHz	CT6	Amplitude et symétrie maximale de l'affichage de l'oscilloscope.	
Répéter les alignements (3) et (4) plusieurs fois.							
(5)	TRANSFORMATEUR FI	Générateur de balayage: 10,7 MHz Connecter la borne RF OUT au générateur de balayage au la broche 5 au IC7 par le 0,022µF condensateur.	Connecter la borne H OUT au générateur de balayage à la borne H (ou X) de l'oscilloscope. Connecter la borne V (ou Y) de l'oscilloscope à la jonction au R132 et R134.	1000 kHz (999 kHz)	L24	Amplitude et symétrie maximale de l'affichage de l'oscilloscope.	(e)

### ABGLEICH (KT-770) Für abgleich von KT-770L, schlagen Sie P.12 nach.

NR.	GEGENSTAND	EINGANGS-EINSTELLUNG	AUSGANGS-EINSTELLUNG	TUNER EINSTELLUNG	ABGLEICHE-PUNKTE	ABGLEICHEN FÜR	ABB.
<b>UKW-EMPFANGSABTEILUNG (KT-770)</b> Außer wenn anders angegeben, die verschiedenen Schalter wie folgt einstellen: SELECTOR: FM MODE: AUTO							
1	BANDKANTE (1)	—	Einen Gleichspannungsmesser zu J44 anschließen.	87,5 MHz	L7	7,5 V	(a)
2	BANDKANTE (2)	—	Einen Gleichspannungsmesser zu J44 anschließen.	108,0 MHz	CT5	23,0 V	(a)
Abstimmungen 1 und 2 mehrere Male wiederholen.							
3	DETEKTOR (1)	(A) 98,0 MHz 0 Hub 100 dB (ANT-Eingang)	Einen Gleichspannungsmesser zwischen TP1 und 2 anschließen.	98,0 MHz	L10	Bestätigen so daß die Spannung beide richtung zu + und - ändert. Dann zu 0 V einstellen.	(b)
4	DETEKTOR (2)	(A) 98,0 MHz 0 Hub 100 dB (ANT-Eingang)	Einen Gleichspannungsmesser zwischen TP3 und 4 anschließen.	98,0 MHz	L12	Bestätigen so daß die Spannung beide richtung zu + und - ändert. Dann zu 0 V einstellen.	(c)
5	HF-ABGLEICH (1)	(A) 90,0 MHz 1 kHz. ±75 kHz Hub 60 dB (ANT-Eingang)	(B)	MODE: MONO 90,0 MHz	L1, 2, 3, 6	Maximal Amplitude und Symmetrie des Oszilloskopbildes.	
6	HF-ABGLEICH (2)	(A) 106,0 MHz 1 kHz. ±75 kHz Hub 60 dB (ANT-Eingang)	(B)	MODE: MONO 106,0 MHz	CT1, 2, 3, 4	Maximal Amplitude und Symmetrie des Oszilloskopbildes.	
Abstimmungen 5 und 6 mehrere Male wiederholen.							
7	ZF-VERSTÄRKUNG	(A) 98,0 MHz 0 Hub 4 dB (ANT-Eingang)	—	98,0 MHz	VR1	Den Pegel widerstand VR1 so einstellen, daß der SIGNAL LED anzeiger nicht leuchtet. Dann der Pegel widerstand aufdrehen, und dem VR1 Halt geben wobei den LED "1" anzeiger leuchtet wird.	
8	SPANNUNGSGEREGLTER OSZILLATOR	(A) 98,0 MHz 0 Hub 60 dB (ANT-Eingang)	Einen Frequenzmesser an TP5 über einen Wechselspannungsmesser anschließen.	98,0 MHz	VR3	76,00 kHz	(d)
9	PILOT-LÖSCHER (1)	(C) 98,0 MHz 0 Hub Wähler: L oder R Pilotten: ±6,75 kHz Hub 60 dB (ANT-Eingang)	(B)	98,0 MHz	VR4	19 kHz Minimaier Ausgang.	

## ABGLEICH

NR.	GEGENSTAND	EINGANGS-EINSTELLUNG	AUSGANGS-EINSTELLUNG	TUNER EINSTELLUNG	ABGLEICHE-PUNKTE	ABGLEICHEN FÜR	ABB.
10	PILOT-LÖSCHER (2)	(C) 98,0 MHz 0 Hub Wähler: L oder R Pilotten: $\pm 6,75$ kHz Hub 60 dB (ANT-Eingang)	(B)	98,0 MHz	L16	Selbe Ausgang. (L, R)	
Abstimmungen 9 und 10 mehrere Male wiederholen.							
11	KLIRRFAKTOR (STEREO) (1)	(C) 98,0 MHz 1 kHz. $\pm 68,25$ kHz Hub Wähler: L oder R Pilotten: $\pm 6,75$ kHz Hub 80 dB (ANT-Eingang)	(B)	98,0 MHz	VR2	Minimale Klirrfaktor.	
12	KLIRRFAKTOR (STEREO) (2)	(C) 98,0 MHz 1 kHz. $\pm 68,25$ kHz Hub Wähler: L oder R Pilotten: $\pm 6,75$ kHz Hub 80 dB (ANT-Eingang)	(B)	98,0 MHz	L5	Minimale Klirrfaktor.	
13	STEREO KANAL TRENNUNG (1)	(C) 98,0 MHz 1 kHz. $\pm 68,25$ kHz Hub Wähler: L oder R Pilotten: $\pm 6,75$ kHz Hub 80 dB (ANT-Eingang)	(B)	98,0 MHz	VR6 (L)	Minimales Übersprechen.	
14	STEREO KANAL TRENNUNG (2)	(C) 98,0 MHz 1 kHz. $\pm 68,25$ kHz Hub Wähler: L oder R Pilotten: $\pm 6,75$ kHz Hub 80 dB (ANT-Eingang)	(B)	98,0 MHz	L15 (Nur gelber Kern)	Minimales Übersprechen.	
Abstimmungen 13 und 14 mehrere Male wiederholen.							
15	STEREO KANAL TRENNUNG (3)	(C) 98,0 MHz 1 kHz. $\pm 68,25$ kHz Hub Wähler: L oder R Pilotten: $\pm 6,75$ kHz Hub 80 dB (ANT-Eingang)	(B)	98,0 MHz	VR5 (R)	Minimales Übersprechen.	
<b>MW-EMPfangSABTEILUNG (KT-770)</b> Die MW-Rahmenantenne angebracht lassen. SELECTOR: AM AM IF BAND: WIDE							
(1)	BANDKANTE (1)	—	Einen Gleichspannungsmesser zu J44 anschließen.	600 kHz (603 kHz)	L23	2,5 V	
(2)	BANDKANTE (2)	—	Einen Gleichspannungsmesser zu J44 anschließen.	1600 kHz (1602 kHz)	CT9	20,0 V	
Abstimmungen (1) und (2) mehrere Male wiederholen.							
(3)	HF-ABGLEICH (1)	(D) 630 kHz 400 Hz, 30% mod	(B)	AM IF BAND: NARROW 630 kHz	L19	Maximale Amplitude und Symmetrie des Oszilloskopbildes.	
(4)	HF-ABGLEICH (2)	(D) 1440 kHz 400 Hz, 30% mod	(B)	AM IF BAND: NARROW 1440 kHz	CT6	Maximale Amplitude und Symmetrie des Oszilloskopbildes.	
Abstimmungen (3) und (4) mehrere Male wiederholen.							
(5)	ZF-ÜBERTRAGER	ZF-Frequenz: 10,7 MHz Die RF-OUT-Klemme des Ablengenerators und Klemme 5 von IC7 über 0,022 $\mu$ F Kondensator anschließen.	Die H-OUT-Klemme des Ablengenerators und die H (oder X)-Klemme des Oszilloskopes anschließen. Die V (oder Y)-Klemme des Oszilloskopes zu Verbindung von R132 und R134 anschließen.	1000 kHz (999 kHz)	L24	Maximale Amplitude und Symmetrie des Oszilloskopbildes.	(e)



## ADJUSTMENT

### ADJUSTMENT (KT-770L)

NO.	ITEM	INPUT SETTING	OUTPUT SETTING	TUNER SETTING	ALIGNMENT POINTS	ALIGN FOR	FIG.
<b>FM SECTION (KT-770L)</b> Unless otherwise specified, the individual switches should be set as follows: SELECTOR: FM MODE: AUTO							
1	BAND EDGE (1)	—	Connect a DC voltmeter to J44.	87.5 MHz	L7	7.5 V	(a)
2	BAND EDGE (2)	—	Connect a DC voltmeter to J44.	108.0 MHz	CT5	23.0 V	(a)
Repeat alignments 1 and 2 several times.							
3	DETECTOR (1)	(A) 98.0 MHz 0 dev 60 dB (ANT input)	Connect a DC voltmeter between TP1 and 2.	98.0 MHz	L10	Confirm that voltage changes to both + and - direction. Then adjust to 0 V.	(b)
4	DETECTOR (2)	(A) 98.0 MHz 0 dev 60 dB (ANT input)	Connect a DC voltmeter between TP3 and 4.	98.0 MHz	L12	Confirm that voltage changes to both + and - direction. Then adjust to 0 V.	(c)
5	RF ALIGNMENT (1)	(A) 90.0 MHz 1 kHz, ±40 kHz dev 60 dB (ANT input)	(B)	MODE: MONO 90.0 MHz	L1, 2, 3, 6	Maximum amplitude and symmetry of the oscilloscope display.	
6	RF ALIGNMENT (2)	(A) 106.0 MHz 1 kHz, ±40 kHz dev 60 dB (ANT input)	(B)	MODE: MONO 106.0 MHz	CT1, 2, 3, 4	Maximum amplitude and symmetry of the oscilloscope display.	
Repeat alignments 5 and 6 several times.							
7	IF GAIN	(A) 98.0 MHz 0 dev 4 dB (ANT input)	—	98.0 MHz	VR1	Adjust VR1 so that SIGNAL LED goes off. Then, adjust VR1 and stop at the point where LED "1" goes on.	
8	VCO	(A) 98.0 MHz 0 dev 60 dB (ANT input)	Connect a frequency counter to TP5 via an AC voltmeter.	98.0 MHz	VR3	76.00 kHz	(d)
9	PILOT CANCELLER (1)	(C) 98.0 MHz 0 dev Selector: L or R Pilot: ±6 kHz dev 60 dB (ANT input)	(B)	98.0 MHz	VR4	Minimum 19 kHz output.	
10	PILOT CANCELLER (2)	(C) 98.0 MHz 0 dev Selector: L or R Pilot: ±6 kHz dev 60 dB (ANT input)	(B)	98.0 MHz	L16	Same output (L, R)	
Repeat alignments 9 and 10 several times.							
11	DISTORTION (STEREO) (1)	(C) 98.0 MHz 1 kHz, ±40 kHz dev Selector: L or R Pilot: ±6 kHz dev 80 dB (ANT input)	(B)	98.0 MHz	VR2	Minimum distortion.	
12	DISTORTION (STEREO) (2)	(C) 98.0 MHz 1 kHz, ±40 kHz dev Selector: L Pilot: ±6 kHz dev 80 dB (ANT input)	(B)	98.0 MHz	CT10	Minimum distortion.	
13	DISTORTION (STEREO) (3)	(C) 98.0 MHz 1 kHz, ±40 kHz dev Selector: L Pilot: ±6 kHz dev 80 dB (ANT input)	(B)	98.0 MHz	L5	Minimum distortion.	
14	SEPARATION (1)	(C) 98.0 MHz 1 kHz, ±40 kHz dev Selector: L Pilot: ±6 kHz dev 80 dB (ANT input)	(B)	98.0 MHz	VR6 (L)	Minimum crosstalk.	

## ADJUSTMENT/REGLAGES

NO.	ITEM	INPUT SETTING	OUTPUT SETTING	TUNER SETTING	ALIGNMENT POINTS	ALIGN FOR	FIG.
15	SEPARATION (2)	(C) 98.0 MHz 10 kHz, ±40 kHz dev Selector: L Pilot: ±6 kHz dev 80 dB (ANT input)	(B)	98.0 MHz	L15 (Yellow core only)	Minimum crosstalk.	
Repeat alignments 14 and 15 several times.							
16	SEPARATION (3)	(C) 98.0 MHz 1 kHz, ±40 kHz dev Selector: R Pilot: ±6 kHz dev 80 dB (ANT input)	(B)	98.0 MHz	VR5 (R)	Minimum crosstalk.	
<b>AM-MW SECTION (KT-770L)</b> Keep the AM loop antenna installed. SELECTOR: MW AM IF BAND: WIDE							
(1)	BAND EDGE MW (1)	—	Connect a DC voltmeter to J44.	600 kHz (603 kHz)	L23	2.5 V	(a)
(2)	BAND EDGE MW (2)	—	Connect a DC voltmeter to J44.	1600 kHz (1602 kHz)	CT9	20.0 V	(a)
Repeat alignments (1) and (2) several times.							
(3)	RF ALIGNMENT MW (1)	(D) 630 kHz 400 Hz, 30% mod	(B)	AM IF BAND: NARROW 630 kHz	L19	Maximum amplitude and symmetry of the oscilloscope display.	
(4)	RF ALIGNMENT MW (2)	(D) 1440 kHz 400 Hz, 30% mod	(B)	AM IF BAND: NARROW 1440 kHz	CT6	Maximum amplitude and symmetry of the oscilloscope display.	
Repeat alignments (3) and (4) several times.							
(5)	IF TRANSFORMER	If frequency: 10.7 MHz Connect RF OUT of sweep generator to pin 5 of IC7 via 0.022µF capacitor.	Connect H OUT of sweep generator and H (or X) terminal of the oscilloscope. Connect V (or Y) terminal of the oscilloscope to the junction of R132 and R134.	1000 kHz (999 kHz)	L24	Maximum amplitude and symmetry of the oscilloscope display.	(e)
<b>AM-LW SECTION</b> SELECTOR: LW AM IF BAND: WIDE							
(6)	BAND EDGE LW (1)	—	Connect a DC voltmeter to J43.	153 kHz	L21	3.5 V	(f)
(7)	BAND EDGE LW (2)	—	Connect a DC voltmeter to J43.	360 kHz	CT8	22.0 V	(f)
Repeat alignments (6) and (7) several times.							
(8)	RF ALIGNMENT LW (1)	(D) 173 kHz 400 Hz, 30% mod	(B)	AM IF BAND: NARROW 173 kHz	L20	Maximum amplitude and symmetry of the oscilloscope display.	
(9)	RF ALIGNMENT LW (2)	(D) 323 kHz 400 Hz, 30% mod	(B)	AM IF BAND: NARROW 323 kHz	CT7	Maximum amplitude and symmetry of the oscilloscope display.	
Repeat alignments (8) and (9) several times.							

### REGLAGES (KT-770L)

N°	ITEM	REGLAGE DE L'ENTREE	REGLAGE DE LA SORTIE	REGLAGE DU TUNER	POINTS DE L'ALIGNEMENT	ALIGNER POUR	FIG.
<b>SECTION MF (KT-770L)</b> Sauf en cas d'indications spéciales, régler chaque commutateur comme suit: SELECTOR: FM MODE: AUTO							
1	BORD DE BANDE (1)	—	Connecter un voltmètre CC au J44.	87,5 MHz	L7	7,0 V	(a)
2	BORD DE BANDE (2)	—	Connecter un voltmètre CC au J44.	108,0 MHz	CT5	23,0 V	(a)
Répéter les alignements 1 et 2 plusieurs fois:							

# REGLAGES

N°	ITEM	REGLAGE DE L'ENTREE	REGLAGE DE LA SORTIE	REGLAGE DU TUNER	POINTS DE L'ALIGNEMENT	ALIGNER POUR	FIG.
3	DETECTEUR (1)	(A) 98,0 MHz 0 dév 60 dB (Entrée ANT)	Connecter un voltmètre CC entre les TP1 et 2.	98,0 MHz	L10	Affermir que la tension change au la, direction von + et - . Alors ajuster au 0 V.	(b)
4	DETECTEUR (2)	(A) 98,0 MHz 0 dév 60 dB (Entrée ANT)	Connecter un voltmètre CC entre les TP3 et 4.	98,0 MHz	L12	Affermir que la tension change au la, direction von + et - . Alors ajuster au 0 V.	(c)
5	ALIGNEMENT HT (1)	(A) 90,0 MHz 1 kHz. ±40 kHz dév 60 dB (Entrée ANT)	(B)	MODE: MONO 90,0 MHz	L1. 2. 3. 6	Amplitude et symétrie maximale de l'affichage de l'oscilloscope.	
6	ALIGNEMENT HT (2)	(A) 106,0 MHz 1 kHz. ±40 kHz dév 60 dB (Entrée ANT)	(B)	MODE: MONO 106,0 MHz	CT1. 2. 3. 4	Amplitude et symétrie maximale de l'affichage de l'oscilloscope.	
Répéter les alignements 5 et 6 plusieurs fois.							
7	FI GAIN	(A) 98,0 MHz 0 dév 4 dB (Entrée ANT)	--	98,0 MHz	VR1	Ajuster VR1 que SIGNAL LED est non allume. Alors, ajuster VR1 et arrêter le mouvement de VR1 au moment où le LED "1" s'allume.	
8	OSCILLATEUR CONTROLE PAR LA TENSION	(A) 98,0 MHz 0 dév 60 dB (Entrée ANT)	Connecter un compteur de fréquence à TP5 par l'intermédiaire d'un voltmètre CA.	98,0 MHz	VR3	76,00 kHz	(d)
9	CIRCUIT SUPPRESSION DE SIGNAL PILOTE (1)	(C) 98,0 MHz 0 dév Selection: L ou R Signal pilote: ±6 kHz dév 60 dB (Entrée ANT)	(B)	98,0 MHz	VR4	19 kHz sortie minimale.	
10	CIRCUIT SUPPRESSION DE SIGNAL PILOTE (2)	(C) 98,0 MHz 0 dév Selection: L ou R Signal pilote: ±6 kHz dév 60 dB (Entrée ANT)	(B)	98,0 MHz	L16	Sortie même (L, R)	
Répéter les alignements 9 et 10 plusieurs fois.							
11	DISTORSION (STEREO) (1)	(C) 98,0 MHz 1 kHz. ±40 kHz dév Selection: L ou R Signal pilote: ±6 kHz dév 80 dB (Entrée ANT)	(B)	98,0 MHz	VR2	Distorsion minimale.	
12	DISTORSION (STEREO) (2)	(C) 98,0 MHz 1 kHz. ±40 kHz dév Selection: L ou R Signal pilote: ±6 kHz dév 80 dB (Entrée ANT)	(B)	98,0 MHz	CT10	Distorsion minimale.	
13	DISTORSION (STEREO) (3)	(C) 98,0 MHz 1 kHz. ±40 kHz dév Selection: L Signal pilote: ±6 kHz dév 80 dB (Entrée ANT)	(B)	98,0 MHz	L5	Distorsion minimale.	
14	SEPARATION (1)	(C) 98,0 MHz 1 kHz. ±40 kHz dév Selection: L Signal pilote: ±6 kHz dév 80 dB (Entrée ANT)	(B)	98,0 MHz	VR6 (L)	Diaphonie minimale.	

## REGLAGES/ABGLEICH

N°	ITEM	RAGLAGE DE L'ENTREE	REGLAGE DE LA SORTIE	REGLAGE DU TUNER	POINTS DE L'ALIGNEMENT	ALIGNER POUR	FIG.
15	SEPARATION (2)	(C) 98,0 MHz 1 kHz. ±40 kHz dév Selection: L Signal pilote: ±6 kHz dév 80 dB (Entrée ANT)	(B)	98,0 MHz	L15 (Le noyau jaune seulement)	Diaphonie minimale.	
Répéter les alignements 13 et 14 plusieurs fois.							
16	SEPARATION (3)	(C) 98,0 MHz 1 kHz. ±40 kHz dév Selection: R Signal pilote: ±6 kHz dév 80 dB (Entrée ANT)	(B)	98,0 MHz	VR5 (R)	Diaphonie minimale.	
<b>SECTION MA-OM (KT-770L)</b> Laisser l'antenne boucle MA installée. SELECTOR: MW AM IF BAND: WIDE							
(1)	BORD DE BANDE OM (1)	—	Connecter un voltmètre CC au J44.	600 kHz (603 kHz)	L23	2,5 V	(a)
(2)	BORD DE BANDE OM (2)	—	Connecter un voltmètre CC au J44.	1600 kHz (1602 kHz)	CT9	20,0 V	(a)
Répéter les alignements (1) et (2) plusieurs fois.							
(3)	ALIGNEMENT HT OM (1)	(D) 630 kHz 400 Hz. 30% mod	(B)	AM IF BAND: NARROW 630 kHz	L19	Amplitude et symétrie maximale de l'affichage de l'oscilloscope.	
(4)	ALIGNEMENT HT OM (2)	(D) 1440 kHz 400 Hz. 30% mod	(B)	AM IF BAND: NARROW 1440 kHz	CT6	Amplitude et symétrie maximale de l'affichage de l'oscilloscope.	
Répéter les alignements (3) et (4) plusieurs fois.							
(5)	TRANSFORMATEUR FI	Générateur de balayage: 10,7 MHz Connecter la borne RF OUT au générateur de balayage au la broche 5 au IC7 par le 0,022µF condensateur.	Connecter la borne H OUT au générateur de balayage à la borne H (ou X) de l'oscilloscope. Connecter la borne V (ou Y) de l'oscilloscope à la jonction au R132 et R134.	1000 kHz (999 kHz)	L24	Amplitude et symétrie maximale de l'affichage de l'oscilloscope.	(e)
<b>SECTION MA-OL (KT-770L)</b> SELECTOR: LW AM IF BAND: WIDE							
(6)	BORD DE BANDE OL (1)	—	Connecter un voltmètre CC au J43.	153 kHz	L21	3,5 V	(f)
(7)	BORD DE BANDE OL (2)	—	Connecter un voltmètre CC au J43.	360 kHz	CT8	22,0 V	(f)
Répéter les alignements (6) et (7) plusieurs fois.							
(8)	ALIGNEMENT HT OL (1)	(D) 173 kHz 400 Hz. 30% mod	(B)	AM IF BAND: NARROW 173 kHz	L20	Amplitude et symétrie maximale de l'affichage de l'oscilloscope.	
(9)	ALIGNEMENT HT OL (2)	(D) 323 kHz 400 Hz. 30% mod	(B)	AM IF BAND: NARROW 323 kHz	CT7	Amplitude et symétrie maximale de l'affichage de l'oscilloscope.	
Répéter les alignements (8) et (9) plusieurs fois.							

### ABGLEICH (KT-770L)

NR.	GEGENSTAND	EINGANGS-EINSTELLUNG	AUSGANG-EINSTELLUNG	TUNER EINSTELLUNG	ABGLEICHE-PUNKTE	ABGLEICHEN FÜR	ABB.
<b>UKW-EMPFANGSABTEILUNG (KT-770L)</b> Außer wenn anders angegeben, die verschiedenen Schalter wie folgt einstellen. SELECTOR: FM MODE: AUTO							
1	BANDKANTE (1)	—	Einen Gleichspannungsmesser zu J44 anschließen.	87,5 MHz	L7	7,5 V	(a)

ABGLEICH

ABGLEICH

NR.	GEGENSTAND	EINGANGS-EINSTELLUNG	AUSGANG-EINSTELLUNG	TUNER EINSTELLUNG	ABGLEICHE-PUNKTE	ABGLEICHEN FÜR	ABB.
2	BANDKANTE (2)	—	Einen Gleichspannungsmesser zu J44 anschließen.	108,0 MHz	CT5	23,0 V	(a)
Abstimmungen 1 und 2 mehrere Male wiederholen.							
3	DETEKTOR (1)	(A) 98,0 MHz 0 Hub 60 dB (ANT-Eingang)	Einen Gleichspannungsmesser zwischen TP1 und 2 anschließen.	98,0 MHz	L10	Bestätigen so daß die Spannung beide richtung zu + und - ändert. Dann zu 0 V einstellen.	(b)
4	DETEKTOR (2)	(A) 98,0 MHz 0 Hub 60 dB (ANT-Eingang)	Einen Gleichspannungsmesser zwischen TP3 und 4 anschließen.	98,0 MHz	L12	Bestätigen so daß die Spannung beide richtung zu + und - ändert. Dann zu 0 V einstellen.	(c)
5	HF-ABGLEICH (1)	(A) 90,0 MHz 1 kHz. ±40 kHz Hub 60 dB (ANT-Eingang)	(B)	MODE: MONO 90,0 MHz	L1. 2. 3. 6	Maximal Amplitude und Symmetrie des Oszilloskopbildes.	
6	HF-ABGLEICH (2)	(A) 106,0 MHz 1 kHz. ±40 kHz Hub 60 dB (ANT-Eingang)	(B)	MODE: MONO 106,0 MHz	CT1. 2. 3. 4	Maximal Amplitude und Symmetrie des Oszilloskopbildes.	
Abstimmungen 5 und 6 mehrere Male wiederholen.							
7	ZF-VERSTÄRKUNG	(A) 98,0 MHz 0 Hub 4 dB (ANT-Eingang)	—	98,0 MHz	VR1	Den Pegel widerstand VR1 so einstellen, daß der SIGNAL LED anzeiger nicht leuchtet. Dann der Pegel widerstand aufdrehen, und dem VR1 Halt geben wobei den LED "1" anzeiger leuchtet wird.	
8	SPANNUNGS-GEREGELTER OSZILLATOR	(A) 98,0 MHz 0 Hub 60 dB (ANT-Eingang)	Einen Frequenzmesser an TP5 über einen Wechselspannungsmesser anschließen.	98,0 MHz	VR3	76,00 kHz	(d)
9	PILOT-LÖSCHER (1)	(C) 98,0 MHz 0 Hub Wähler: L oder R Piloten: ±6 kHz Hub 60 dB (ANT-Eingang)	(B)	98,0 MHz	VR4	19 kHz Minimaler Ausgang.	
10	PILOT-LÖSCHER (2)	(C) 98,0 MHz 0 Hub Wähler: L oder R Piloten: ±6 kHz Hub 60 dB (ANT-Eingang)	(B)	98,0 MHz	L16	Selbe Ausgang. (L, R)	
Abstimmungen 9 und 10 mehrere Male wiederholen.							
11	KLIRRFAKTOR (STEREO) (1)	(C) 98,0 MHz 1 kHz. ±40 kHz Hub Wähler: L oder R Piloten: ±6 kHz Hub 80 dB (ANT-Eingang)	(B)	98,0 MHz	VR2	Minimale Klirrfaktor.	
12	KLIRRFAKTOR (STEREO) (2)	(C) 98,0 MHz 1 kHz. ±40 kHz Hub Wähler: L oder R Piloten: ±6 kHz Hub 80 dB (ANT-Eingang)	(B)	98,0 MHz	CT10	Minimale Klirrfaktor.	
13	KLIRRFAKTOR (STEREO) (3)	(C) 98,0 MHz 1 kHz. ±40 kHz Hub Wähler: L oder R Piloten: ±6 kHz Hub 80 dB (ANT-Eingang)	(B)	98,0 MHz	L5	Minimale Klirrfaktor.	
14	STEREO KANAL TRENNUNG (1)	(C) 98,0 MHz 1 kHz. ±40 kHz Hub Wähler: L oder R Piloten: ±6 kHz Hub 80 dB (ANT-Eingang)	(B)	98,0 MHz	VR6 (L)	Minimales Übersprechen.	

NR.	GEGENSTAND	EINGANGS-EINSTELLUNG	AUSGANG-EINSTELLUNG	TUNER EINSTELLUNG	ABGLEICHE-PUNKTE	ABGLEICHEN FÜR	ABB.
15	STEREO KANAL TRENNUNG (2)	(C) 98,0 MHz 1 kHz. ±40 kHz Hub Wähler: L oder R Piloten: ±6 kHz Hub 80 dB (ANT-Eingang)	(B)	98,0 MHz	L15 (Nur gelber Kern)	Minimales Übersprechen.	
Abstimmungen 13 und 14 mehrere Male wiederholen.							
16	STEREO KANAL TRENNUNG (3)	(C) 98,0 MHz 1 kHz. ±40 kHz Hub Wähler: L oder R Piloten: ±6 kHz Hub 80 dB (ANT-Eingang)	(B)	98,0 MHz	VR5 (R)	Minimales Übersprechen.	
<b>MW-EMPfangSABTEILUNG (KT-770L)</b> Die MW-Rahmenantenne angebracht lassen. SELECTOR: AM AM IF BAND: WIDE							
(1)	BANDKANTE MW (1)	—	Einen Gleichspannungsmesser zu J44 anschließen.	600 kHz (603 kHz)	L23	2,5 V	
(2)	BANDKANTE MW (2)	—	Einen Gleichspannungsmesser zu J44 anschließen.	1600 kHz (1602 kHz)	CT9	20,0 V	
Abstimmungen (1) und (2) mehrere Male wiederholen.							
(3)	HF-ABGLEICH MW (1)	(D) 630 kHz 400 Hz. 30% mod	(B)	AM IF BAND: NARROW 630 kHz	L19	Maximale Amplitude und Symmetrie des Oszilloskopbildes.	
(4)	HF-ABGLEICH MW (2)	(D) 1440 kHz 400 Hz. 30% mod	(B)	AM IF BAND: NARROW 1440 kHz	CT6	Maximale Amplitude und Symmetrie des Oszilloskopbildes.	
Abstimmungen (3) und (4) mehrere Male wiederholen.							
(5)	ZF-ÜBERTRAGER	ZF-Frequenz: 10,7 MHz Die RF-OUT-Klemme des Ablenkgenerators und Klemme 5 von IC7 über 0,022µF Kondensator anschließen.	Die H-OUT-Klemme des Ablenkgenerators und die H (oder X)-Klemme des Oszilloskopes anschließen. Die V (oder Y)-Klemme des Oszilloskopes zu verbinding von R132 und R134 anschließen.	1000 kHz (999 kHz)	L24	Maximale Amplitude und Symmetrie des Oszilloskopbildes.	(e)
<b>LW-EMPfangSABTEILUNG (KT-770L)</b> SELECTOR: AM AM IF BAND: WIDE							
(6)	BANDKANTE LW (1)	—	Einen Gleichspannungsmesser zu J43 anschließen.	153 kHz	L21	3,5 V	(f)
(7)	BANDKANTE LW (2)	—	Einen Gleichspannungsmesser zu J43 anschließen.	360 kHz	CT8	22,0 V	(f)
Abstimmungen (6) und (7) mehrere Male wiederholen.							
(8)	HF-ABGLEICH LW (1)	(D) 173 kHz 400 Hz. 30% mod	(B)	AM IF BAND: NARROW 173 kHz	L20	Maximale Amplitude und Symmetrie des Oszilloskopbildes.	
(9)	HF-ABGLEICH LW (2)	(D) 323 kHz 400 Hz. 30% mod	(B)	AM IF BAND: NARROW 323 kHz	CT7	Maximale Amplitude und Symmetrie des Oszilloskopbildes.	
Abstimmungen (8) und (9) mehrere Male wiederholen.							

## PC BOARD

TUNER UNIT (X05-2510-11) Component side view

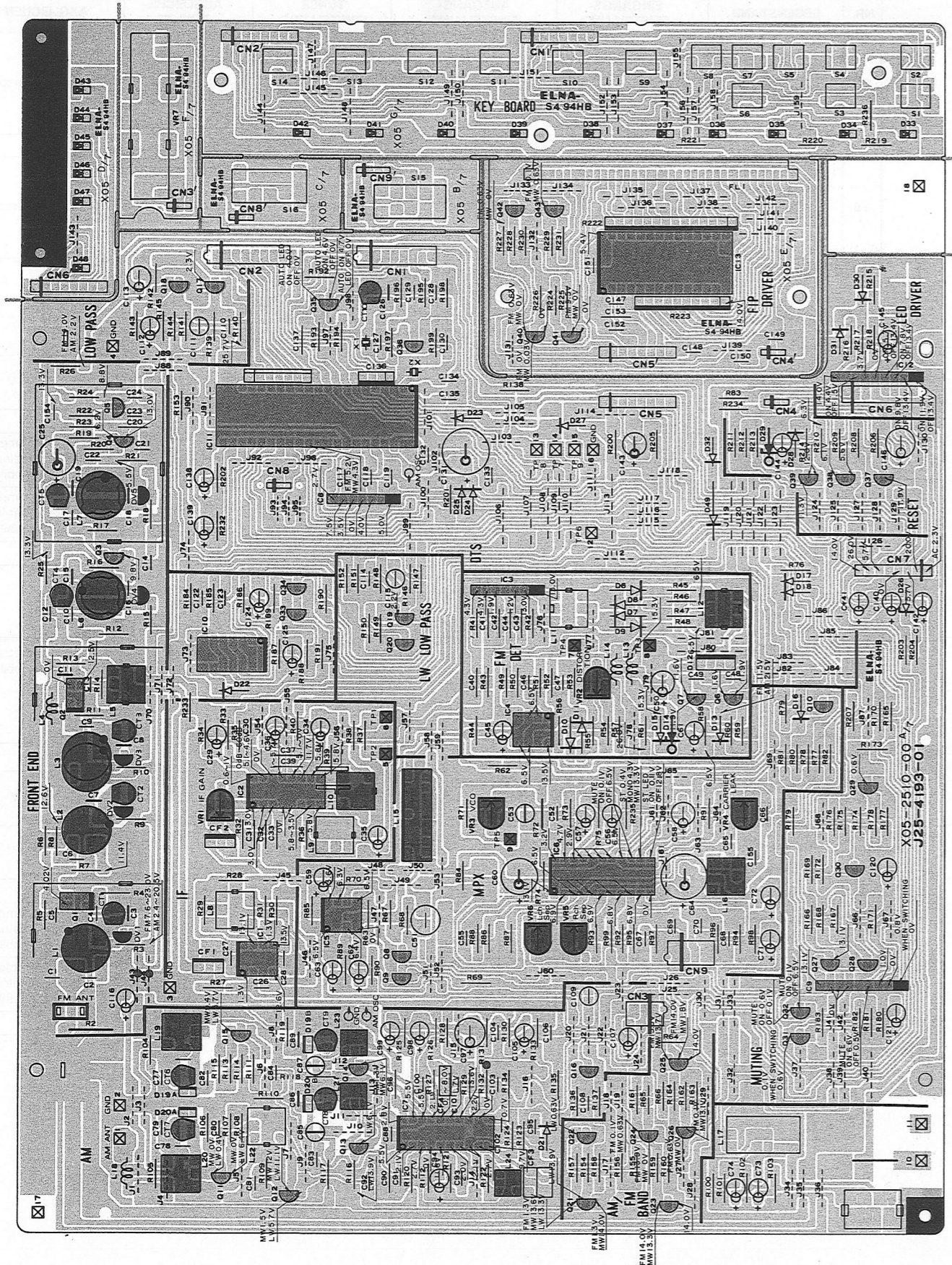

IC11

No.	Voltage
1	0V
2	2.2V
3	2.5V
4	FM 4.4V MW 0V
5	MW ON 4.2V LED OFF 0V
6	LW ON 4.2V LED OFF 1.2V
7	AT LW ON 4.9V AUTO OFF 3.6V
8	AUTO ON 4.9V LED OFF 0V
9	UP ON 5.0V SW OFF 0V
10	DOWN ON 5.0V SW OFF 0V
11	MEMO- ON 4.2V RY LED OFF 0V
12	CH1- LED
13	CH2- LED
14	CH3- LED
15	CH4- ON 4.2V LED OFF 0V
16	CH5- LED
17	CH6- LED
18	-
19	-
20	-
21	-

POWER SUPPLY UNIT (X00-2250-00)  
Component side view

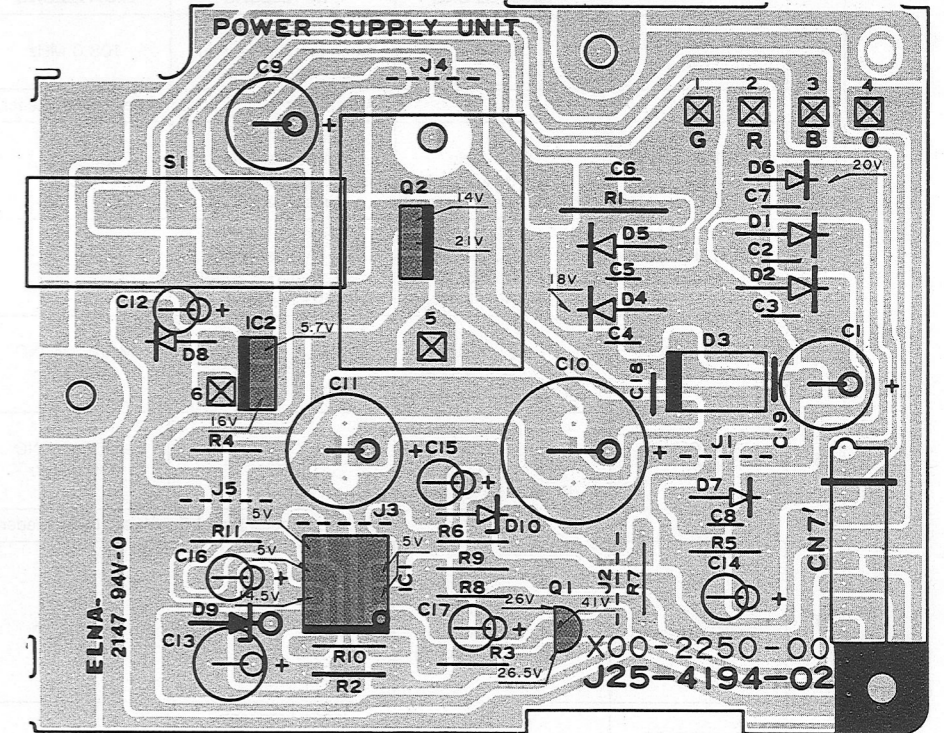

No.	Voltage
22	0V
23	-
24	FM 4.9V MW 0V
25	0V
26	-
27	-
28	-
29	-
30	-
31	FM 5.2V MW 4.3V
32	0V
33	0V
34	FM 0.9V MW 0.9V
35	0V
36	-
37	-
38	FM 2.8V MW 0V
39	FM 4.8V MW 2.1V
40	4.75V
41	0V
42	0V

Refer to the schematic diagram for the values of resistors and capacitors.  
The PC board drawing is viewing from the side easy to check.

2SA733 (A)  
2SA999  
2SB764  
2SC2320  
2SC461  
2SC945 (A)  
2SD863

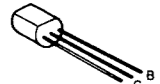

2SD882

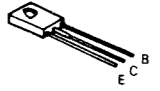

2SK105  
2SK163

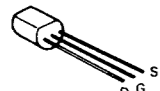

3SK73

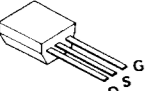

2SK161  
2SK241

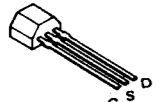

LA1222  
NJM4560D-N

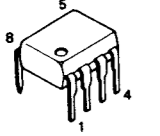

TD6104P  
TD6301AP

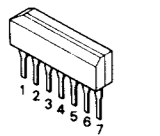

AN6135  
AN6876

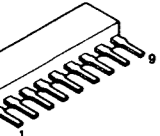

UPD4011BC

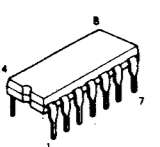

LA1231NS

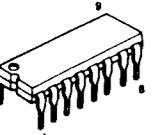

LA1245

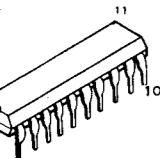

UPC1163H

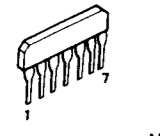

2  
3  
4  
5  
6

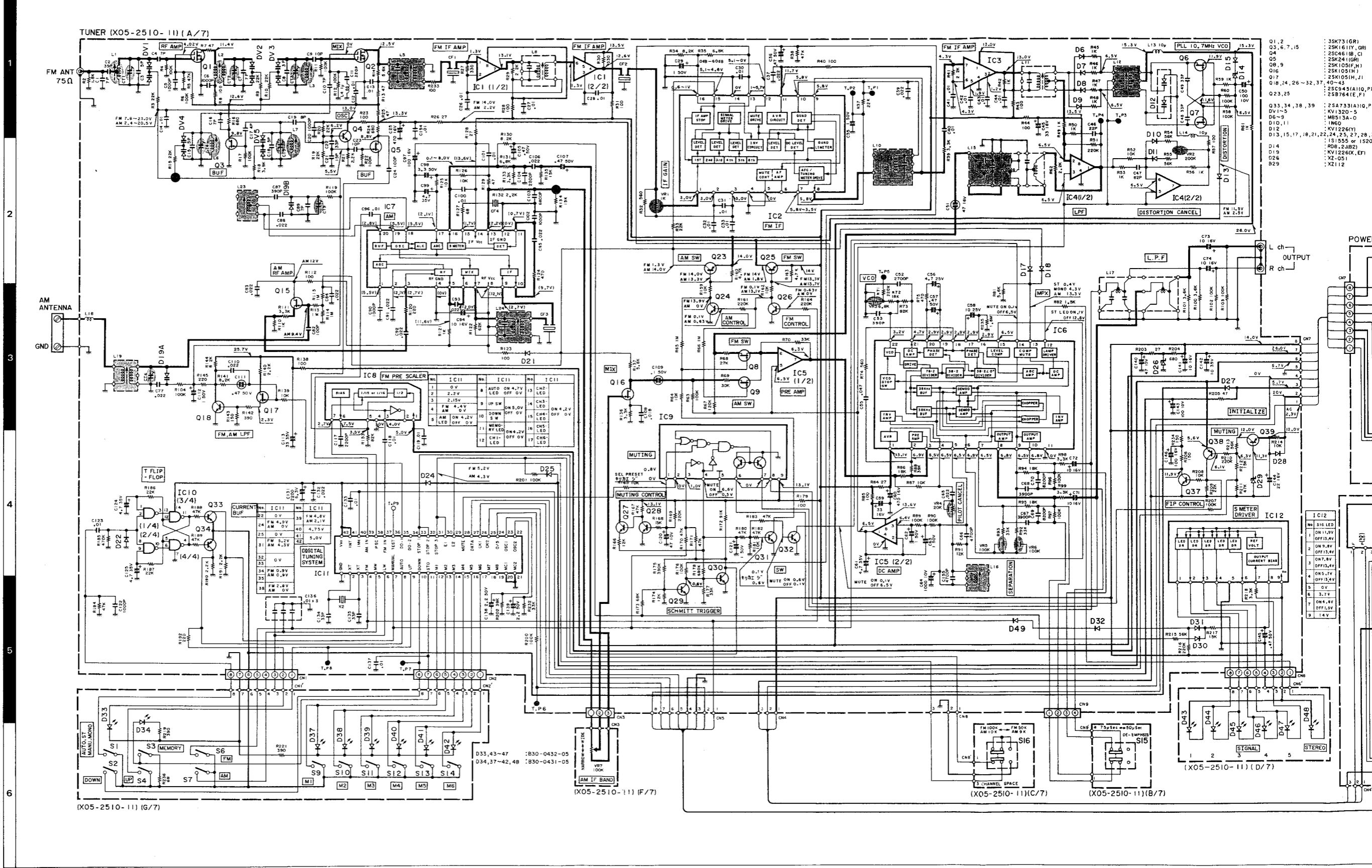

AN6552

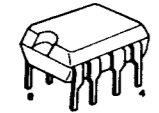

TC9157P

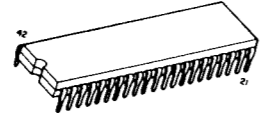

UPC1223C

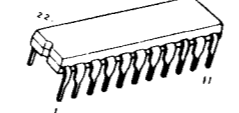

UPC78M05H

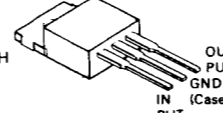

CAUTION: For continued safety, replace safety components only with manufacturer's recommended to parts list.  Indicates safety critical components. Failure to replace these components may reduce the risk of electric shock, leakage-current

# QUARTZ SYNTHESIZER TUNER

# KT-770

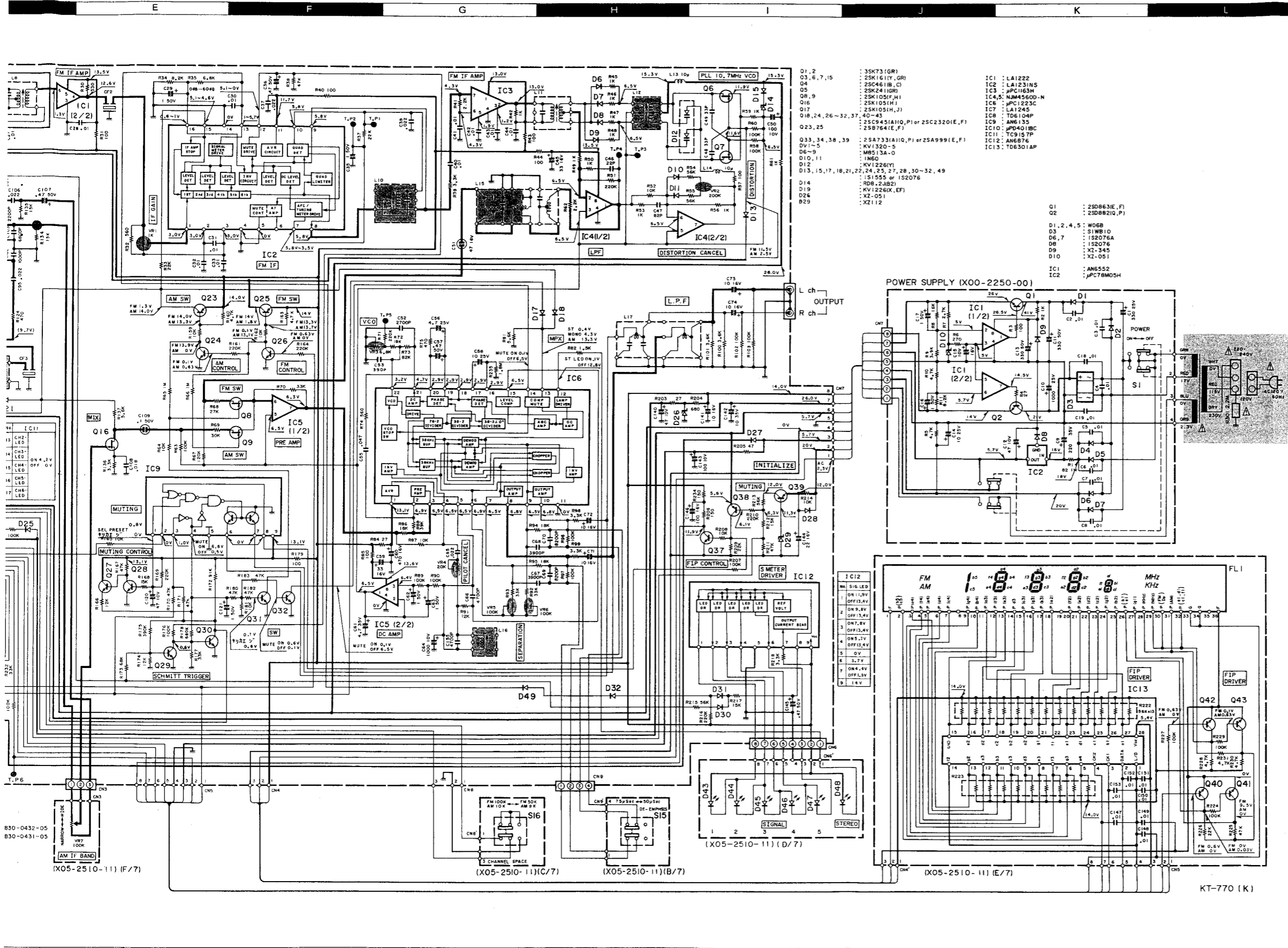

## SPECIFICATIONS

**[FM tuner section]**

Usable sensitivity	10.8 dBf (0.95 μV)
50 dB quieting sensitivity	
Mono	16.2 dBf (1.8 μV)
Stereo	38.8 dBf (24 μV)
Signal to noise ratio at 65 dBf	
Mono	88 dB
Stereo	76 dB
Total harmonic distortion at 1 kHz	
Mono	0.02%
Stereo	0.04%
Frequency response	20 Hz to 15 kHz ±0.5 dB
Capture ratio	1 dB
Image rejection ratio	82 dB
Spurious rejection ratio	100 dB
IF rejection ratio	110 dB
Alternate channel selectivity	60 dB
AM suppression ratio	70 dB
Stereo separation ratio	66 dB at 1 kHz
45 dB at 50 Hz to 10 kHz	
Antenna impedance	75 ohms unbalanced
Output level at 1 kHz, 100% mod	0.6V/1.7 kohms

**[AM tuner section]**

Usable sensitivity	10 μV
Signal to noise ratio	52 dB
Total harmonic distortion	0.3% (WIDE), 0.8% (NARROW)
Image rejection	40 dB
Output level	0.18V/1.7 kohms

**[General]**

Power requirements	50/60 Hz 120/220-240V, Switchable
Power consumption	12W
Dimensions	W: 420 mm (16-17/32") H: 64 mm (2-1/2") D: 317 mm (12-1/2")
Weight (Net)	3.4 kg (7.5 lb)

Kenwood follows a policy of continuous advancements in development. For this reason specifications may be changed without notice.

Kenwood poursuit une politique de progrès constants en ce qui concerne le développement. Pour cette raison, les spécifications sont sujettes à modifications sans préavis.

Kenwood strebt ständige Verbesserungen in der Entwicklung an. Daher bleiben Änderungen der technischen Daten jederzeit vorbehalten.

DC voltages are as measured with a high impedance voltmeter during reception of the FM broadcast signal (with a signal strength of 60 dB at the ANT terminal). Values may vary slightly due to variations between individual instruments or/and units. Values in parentheses are as measured during reception of the AM broadcast signal (with a signal strength of 60 dB at the ANT terminal).

**CAUTION:** For continued safety, replace safety critical components only with manufacturer's recommended parts (refer to parts list). Indicates safety critical components. To reduce the risk of electric shock, leakage-current or resistance measurements shall be carried out (exposed parts are acceptably insulated from the supply circuit) before the appliance is returned to the customer.

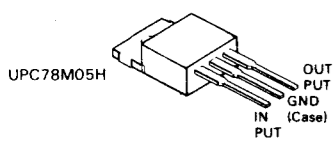



- 2SA733 (A)
- 2SA999
- 2SB764
- 2SC2320
- 2SC461
- 2SC945 (A)
- 2SD863
  
- 2SD882
  
- 2SK105
- 2SK163
  
- 3SK73
  
- 2SK161
- 2SK241
  
- LA1222
- NJM4560D-N
  
- TD6104P
- TD6301AP
  
- AN6135
- AN6876
  
- UPD4011BC
  
- LA1231NS
  
- LA1245
  
- UPC1163H

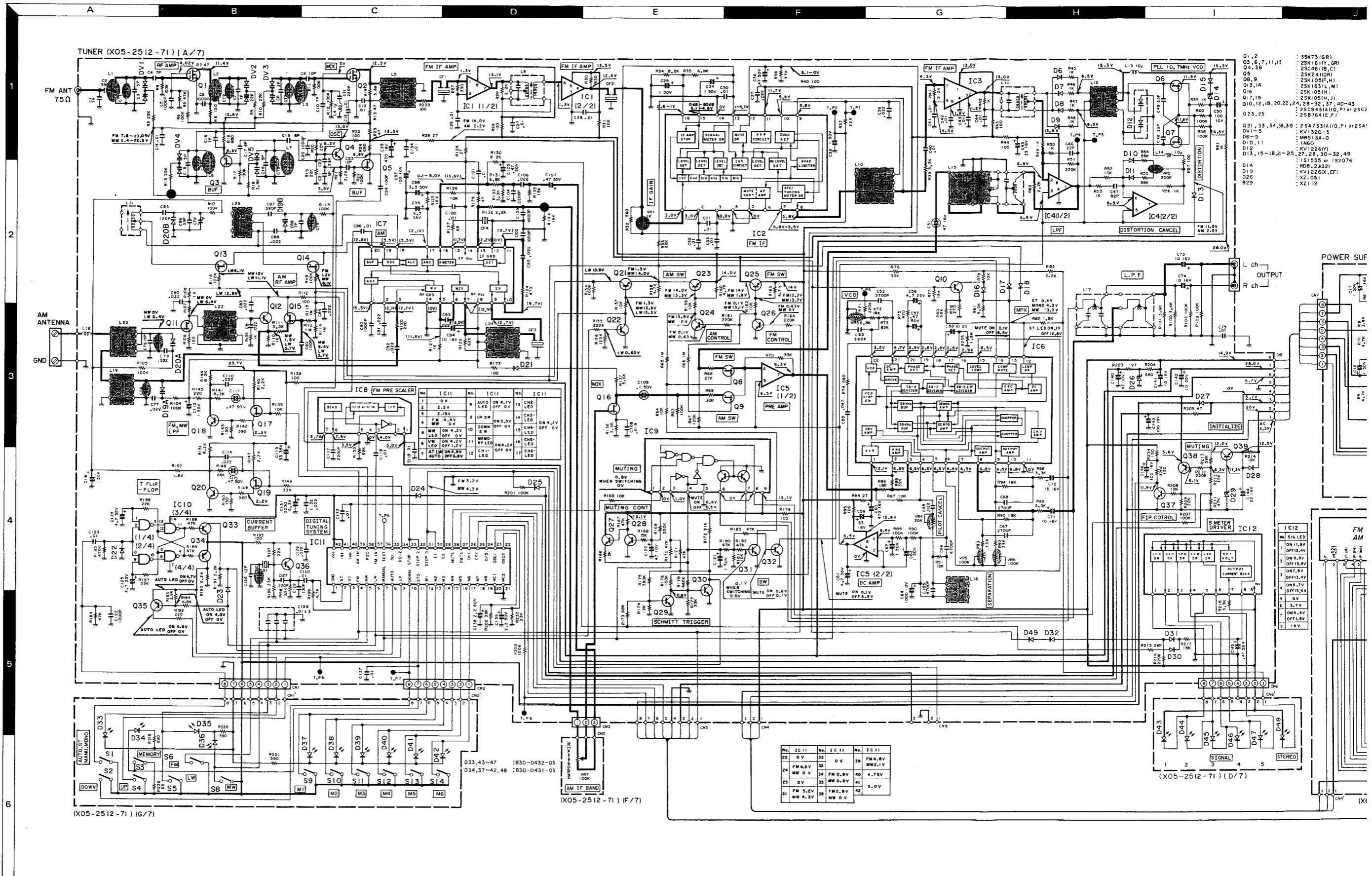

- 16 AN6552
- TC9157P
- UPC1223C
- UPC78M05H

**CAUTION:** For continued safety, replace safety critical components only with manufacturer's recommended parts (to parts list). Indicates safety critical components. reduce the risk of electric shock, leakage-current or resin.

# QUARTZ SYNTHESIZER TUNER

# KT-770L



## SPECIFICATIONS

FM tuner section	
Sensitivity at 75 ohms	
Mono: S/N 26 dB, 40 kHz Dev	0.7 $\mu$ V
Stereo: S/N 46 dB, 46 kHz Dev	26 $\mu$ V
Limiting Level	
-3 dB, Point, 40 kHz Dev	0.45 $\mu$ V
Frequency Response	20 Hz - 15 kHz $\pm$ 0.5 dB
Total Harmonic Distortion	
Mono: 1 kHz, 40 kHz Dev	0.1%
Stereo: 1 kHz, 46 kHz Dev	0.38%
S/N Weighted (IEC-A)	
Mono: 40 kHz Dev., 1 mV Input	74 dB
Stereo: 46 kHz Dev., 1 mV Input	66 dB
S/N Ratio (IHF)	
Mono: 75 kHz Dev., 1 mV Input	80 dB
Stereo: 75 kHz Dev., 1 mV Input	70 $\mu$ V
FM Stereo Separation: 1 mV Input (DIN)	
250 Hz:	46 dB
1 kHz:	48 dB
6.3 kHz:	44 dB
12.5 kHz:	32 dB
Image Rejection Ratio	82 dB
Selectivity	
300 kHz, 20 dB input	85 dB
IF Rejection Ratio	110 dB
AM Suppression Ratio	70 dB
Spurious Rejection Ratio	100 dB
Capture Ratio	2.5 dB
MW tuner section	
Sensitivity S/N 20 dB	10 $\mu$ V
S/N Ratio: 1 mV Input	52 dB
Image Rejection Ratio	40 dB
LW tuner section	
Sensitivity S/N 20 dB	10 $\mu$ V
S/N Ratio: 1 mV Input	52 dB
Image Rejection Ratio	70 dB
General	
Power Consumption	
IEC	12 W
Dimensions (W x H x D)	420 x 64 x 317 mm
Weight (Net)	3.4 kg

Kenwood follows a policy of continuous advancements in development. For this reason specifications may be changed without notice.

Kenwood poursuit une politique de progrès constants en ce qui concerne le développement. Pour cette raison, les spécifications sont sujettes à modifications sans préavis.

Kenwood strebt ständige Verbesserungen in der Entwicklung an. Daher bleiben Änderungen der technischen Daten jederzeit vorbehalten.

DC voltages are as measured with a high impedance voltmeter during reception of the FM broadcast signal (with a signal strength of 60 dB at the ANT terminal). Values may vary slightly due to variations between individual instruments or/and units. Values in parentheses are as measured during reception of the AM broadcast signal (with a signal strength of 60 dB at the ANT terminal).

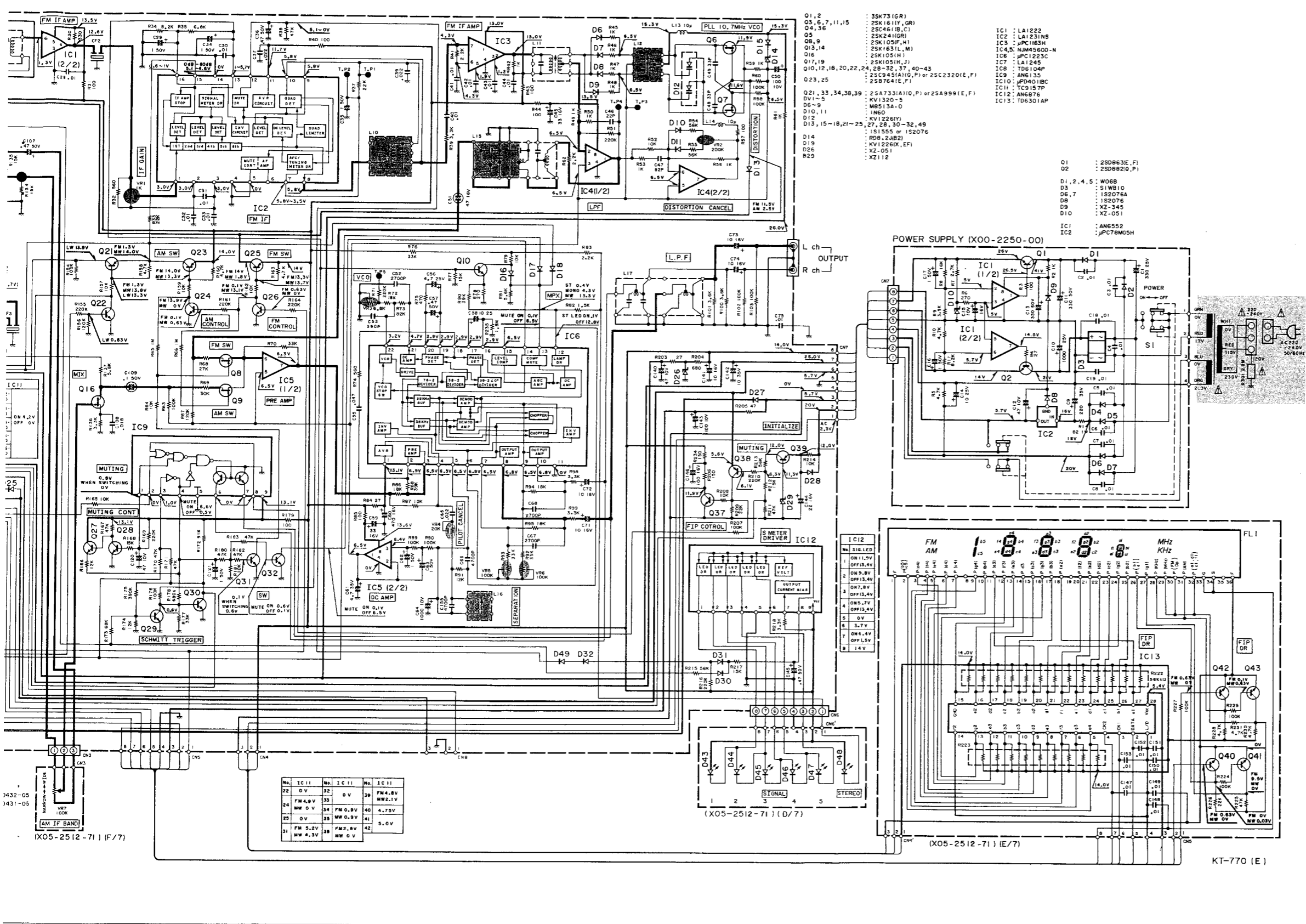

- Q1, 2 : 3SK73 (GR)
- Q3, 6, 7, 11, 15 : 2SK161 (Y, GR)
- Q4, 36 : 2SC46 (B, C)
- Q5 : 2SK241 (GR)
- Q8, 9 : 2SK105 (F, H)
- Q13, 14 : 2SK163 (L, M)
- Q16 : 2SK105 (H, I)
- Q17, 19 : 2SK105 (H, J)
- Q10, 12, 18, 20, 22, 24, 28-32, 37, 40-43 : 2SC945 (A1, G, P) or 2SC2320 (E, F)
- Q23, 25 : 2SB76 (E, F)
- Q21, 33, 34, 38, 39 : 2SA733 (A1, D, P) or 2SA999 (E, F)
- DV1-5 : KVI320-5
- D6-9 : M8513A-0
- D10, 11 : IN60
- D12 : KVI226 (V)
- D13, 15-18, 21-25, 27, 28, 30-32, 49 : 1S1555 or 1S2076
- D14 : ROB-2 (MBZ)
- D19 : KVI226 (X, EF)
- D26 : XZ-051
- D29 : XZ-051
- D1 : 2SD863 (E, F)
- D2 : 2SD882 (D, P)
- D1, 2, 4, 5 : W068
- D3 : S1WB10
- D6, 7 : 1S2076A
- D8 : 1S2076
- D9 : XZ-345
- D10 : XZ-051
- IC1 : AN6552
- IC2 : PCT8M05H

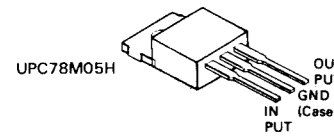

**CAUTION:** For continued safety, replace safety critical components only with manufacturer's recommended parts (refer to parts list). Indicates safety critical components. To reduce the risk of electric shock, leakage-current or resistance measurements shall be carried out (exposed parts are acceptably insulated from the supply circuit) before the appliance is returned to the customer.

# KT-770/L KT-770/L

## EXPLODED VIEW

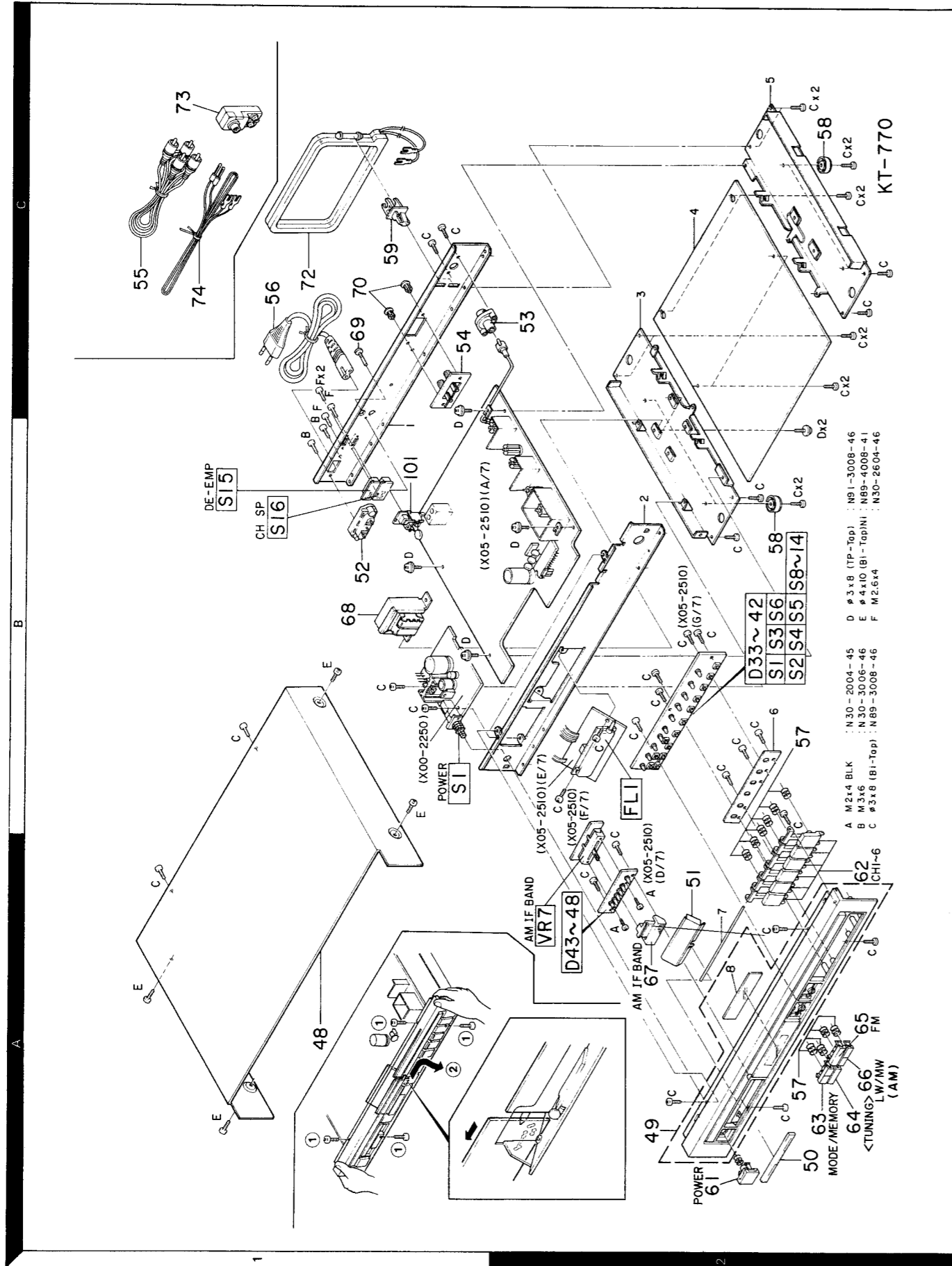

## PARTS LIST

\* New Parts  
 Parts without Parts No. are not supplied.  
 Les articles non mentionnés dans le Parts No. ne sont pas fournis.  
 Teile ohne Parts No. werden nicht geliefert.

Ref. No.	Address	New Parts	Parts No.	Description	Desti-nation	Re-marks
参照番号	位置	新	部品番号	部品名 / 規格	仕 向	備考
<b>KT-770/770L</b>						
48	1A	*	A01-0644-03	METALLIC CABINET		
49	2A	*	A20-3544-03	PANEL ASSY	KPUM	
49	2A	*	A20-3544-03	PANEL ASSY	UEX	
49	2A	*	A20-3545-03	PANEL ASSY	T	
49	2A	*	A20-3658-03	PANEL ASSY	E	
50	2A	*	B03-0299-04	DRESSING PLATE		
51	2A	*	B03-0300-04	DRESSING PLATE		
-	-	-	B46-0092-03	WARRANTY CARD	K	
-	-	-	B46-0093-03	WARRANTY CARD	P	
-	-	-	B46-0094-03	WARRANTY CARD	UUE	
-	-	-	B46-0095-03	WARRANTY CARD	UUE	
-	-	-	B46-0096-03	WARRANTY CARD	X	
-	-	-	B46-0097-03	WARRANTY CARD	T	
-	-	-	B46-0098-03	WARRANTY CARD	E	
-	-	*	B50-4874-00	INSTRUCTION MANUAL (ENGLISH)	KPUM	
-	-	*	B50-4874-00	INSTRUCTION MANUAL (ENGLISH)	UEX	
-	-	*	B50-4875-00	INSTRUCTION MANUAL (FRENCH)	PMX	
-	-	*	B50-4876-00	INSTRUCTION MANUAL (SPANISH)	M	
-	-	*	B50-4877-00	INSTRUCTION MANUAL (ENGLISH)	T	
-	-	*	B50-4878-00	INSTRUCTION MANUAL (F,G,D,SW,I)	E	
Δ 52	1B		E03-0102-15	AC INLET		
53	2C		E04-0006-05	RF COAXIAL CABLE RECEPTACLE		
54	1C		E20-0228-05	SCREW TERMINAL BOARD (ANTENNA)		
55	1C		E30-0505-05	AUDIO CORD		
Δ 56	1C		E30-0687-05	AC POWER CORD (INLET)	KP	
Δ 56	1C		E30-1305-15	AC POWER CORD (INLET)	UMUE	
Δ 56	1C		E30-1328-15	AC POWER CORD (INLET)	T	
Δ 56	1C		E30-1329-05	AC POWER CORD (INLET)	E	
Δ 56	1C		E30-1342-05	AC POWER CORD (INLET)	X	
57	2B	*	G01-1377-04	COMPRESSION SPRING(KNOB)		
-	-	*	H01-4798-04	ITEM CARTON CASE	KPUM	
-	-	*	H01-4798-04	ITEM CARTON CASE	UEX	
-	-	*	H01-4856-04	ITEM CARTON CASE	T	
-	-	*	H01-4862-04	ITEM CARTON CASE	E	
-	-	*	H10-1671-13	POLYSTYRENE FOAMED FIXTURE		
-	-		H20-0452-04	PROTECTION COVER(450X230X350)		
-	-		H25-0078-04	PROTECTION BAG (235X315)		
-	-		H25-0181-04	PROTECTION BAG (150X260X0.05)		
58	1B, 1C		J02-0130-05	FOOT		
59	1C		J19-0626-12	ANTENNA HOLDER		
-	-		J61-0307-05	WIRE BAND		
61	2A	*	K27-1000-04	KNOB (BUTTON) POWER		
62	2A	*	K27-1001-03	KNOB (BUTTON) CH1-6		
63	2A	*	K27-1007-03	KNOB (BUTTON) MODE/MEMORY		
64	2A	*	K27-1008-03	KNOB (BUTTON) TUNING		
65	2A	*	K27-1009-03	KNOB (BUTTON) FM		
66	2A	*	K27-1010-03	KNOB (BUTTON) AM	KPUM	
66	2A	*	K27-1010-03	KNOB (BUTTON) AM	UEX	
66	2A	*	K27-1011-03	KNOB (BUTTON) LW/MW	T	
67	2A	*	K27-1012-04	KNOB (LEVER) AM IF BAND	E	
Δ 68	1B	*	L01-3144-05	POWER TRANSFORMER		

E: Scandinavia & Europe H: Audio Club K: USA P: Canada Δ indicates safety critical components.  
 S: South Africa T: England U: PX(Far East, Hawaii)  
 UE: AAFES(Europe) X: Australia M: Other Areas

## PARTS LIST

\* New Parts  
 Parts without Parts No. are not supplied.  
 Les articles non mentionnés dans le Parts No. ne sont pas fournis.  
 Teile ohne Parts No. werden nicht geliefert.

Ref. No. 参照番号	Address 位置	New Parts 新	Parts No. 部品番号	Description 部品名/規格	Desti- nation 仕向	Re- marks 備考
69 70	1C 1C		N09-0399-15 N29-0035-05	STEPPED SCREW (3X19,BI) PUSH RIVET	KPTE	
△ R301			R92-0173-05	RC 2.2M M 2H	KP	
72 73 74	1C 1C 1C		T90-0111-15 T90-0122-05 T90-0132-05	LOOP ANTENNA ANTENNA ADAPTOR T TYPE ANTENNA		
<b>POWER SUPPLY UNIT (X00-2250-00)</b>						
C1 C2 -8 C9 C10 C11		*	CE04FW1E331M CK45FF1H103Z CE04FW1V221M CE04FW1E102M CE04FW1H331M	ELECTR0 330UF 25WV CERAMIC 0.01UF Z ELECTR0 220UF 35WV ELECTR0 1000UF 25WV ELECTR0 330UF 50WV		
C12 C13 C14 C15 C16 ,17			CE04FW1A470M CE04W1H331M CE04FW1E100M CE04FW1C100M CE04FW1H010M	ELECTR0 47UF 10WV ELECTR0 330UF 50WV ELECTR0 10UF 25WV ELECTR0 10UF 16WV ELECTR0 1UF 50WV		
C18 ,19			CK45FF1H103Z	CERAMIC 0.01UF Z		
R1 R2			RS14GB3A820J RD14GB2E102J	FL-PROOF RS 82 J 3A FL-PROOF RD 1K J 2E		
S1	1B	*	S40-4053-05	PUSH SWITCH (POWER)		
D1 ,2 D3 D4 ,5 D6 ,7 D8			W06B S1WB10 W06B 1S2076A 1S2076	DIODE DIODE DIODE DIODE DIODE		
D9 D10 IC1 IC2 Q1		*	RD36E(B3) RD5.1E(B3) AN6552 UPC78M05H 2SD863(E,F)	ZENER DIODE ZENER DIODE IC IC (VOLTAGE REGULATOR) +5V TRANSISTOR		
Q2			2SD882(Q,P)	TRANSISTOR		
<b>TUNER UNIT (X05-2510-11)</b>						
D33 D34 D35 ,36 D37 -42 D43 -47			B30-0432-05 B30-0431-05 B30-0431-05 B30-0431-05 B30-0432-05	LED(LN31GCPH(U)) MODE LED(LN21CPH) MEMORY LED(LN21CPH) LW,MW LED(LN21CPH) CH1-6 LED(LN31GCPH(U)) SIGNAL	TE	
D48			B30-0431-05	LED(LN21CPH) STEREO		
C1 C2 C3 C4 C5 ,6		*	CC45FSL1H070D CC45FSL1H390J CC45FTH1H050C CC45FSL1H070D CK45FB1H102K	CERAMIC 7.0PF D CERAMIC 39PF J CERAMIC 5PF C CERAMIC 7.0PF D CERAMIC 0.001UF K		
C7 C8 C9 C10 C11		*	CC45FTH1H070D CC45FTH1H030C CC45FSL1H100D CC45FSL1H070D CC45FSL1H221J	CERAMIC 7.0PF D CERAMIC 3.0PF C CERAMIC 10PF D CERAMIC 7.0PF D CERAMIC 220PF J		
C12 -14			CK45FF1H103Z	CERAMIC 0.01UF Z		

E: Scandinavia & Europe H: Audio Club K: USA P: Canada  
 S: South Africa T: England U: PX(Far East, Hawaii)  
 UE: AAFES(Europe) X: Australia M: Other Areas  
 △ indicates safety critical components.

## PARTS LIST

\* New Parts  
 Parts without Parts No. are not supplied.  
 Les articles non mentionnés dans le Parts No. ne sont pas fournis.  
 Teile ohne Parts No. werden nicht geliefert.

Ref. No. 参照番号	Address 位置	New Parts 新	Parts No. 部品番号	Description 部品名/規格	Desti- nation 仕向	Re- marks 備考
C15 C16 C17 C18 C19		*	CC45FTH1H050C CC45FSL1H070D CC45FSL1H040C CC45FTH1H050C CC45FTH1H080D	CERAMIC 5PF C CERAMIC 7.0PF D CERAMIC 4.0PF C CERAMIC 5PF C CERAMIC 8PF D		
C20 C21 C22 C23 C24			CK14D1H102M CC45FSL1H150J CC45FSL1H330J CC45FSL1H100D CC45FSL1H101J	CERAMIC 1000PF M CERAMIC 15PF J CERAMIC 33PF J CERAMIC 10PF D CERAMIC 100PF J		
C25 C26 -28 C29 C30 ,31 C32			CE04FW1C471M CK45FF1H103Z CE04FW1H010M CK45FF1H103Z C91-0083-05	ELECTR0 470UF 16WV CERAMIC 0.01UF Z ELECTR0 1UF 50WV CERAMIC 0.01UF Z CERAMIC 0.01UF N		
C33 C34 ,35 C35 C36			CK45FF1H103Z CE04FW1H010M CE04FW1H010M CE04FW1H010M CE04FW1HR47M	CERAMIC 0.01UF Z ELECTR0 1UF 50WV ELECTR0 1UF 50WV ELECTR0 1UF 50WV ELECTR0 0.47UF 50WV	TE KPUM UEX	
C37 C39 C40 -44 C45 C46			C91-0085-05 C91-0085-05 C91-0083-05 CE04FW1C330M CC45FSL1H220J	CERAMIC 0.022UF N CERAMIC 0.022UF N CERAMIC 0.01UF N ELECTR0 33UF 16WV CERAMIC 22PF J		
C47 C48 ,49 C50 C51 C52			CC45FSL1H820J CC45FCH1H330J CE04FW1A101M CE04HW1C470M CQ93FM1H272K	CERAMIC 82PF J CERAMIC 33PF J ELECTR0 100UF 10WV NP-ELEC 47UF 16WV MYLAR 0.0027UF K		
C53 C55 C56 C57 C58		*	CQ09FS1H391J CQ93FM1H473K CE04GW1E4R7M CE04GW1HR47M CE04GW1E100M	POLYSTY 390PF J MYLAR 0.047UF K LL-ELEC 4.7UF 25WV LL-ELEC 0.47UF 50WV LL-ELEC 10UF 25WV		
C59 C60 C61 C62 ,63 C64			CE04FW1C330M CE04FW1C471M CE04FW1V4R7M CE04FW1H010M CE04FW1A102M	ELECTR0 33UF 16WV ELECTR0 470UF 16WV ELECTR0 4.7UF 35WV ELECTR0 1UF 50WV ELECTR0 1000UF 10WV		
C65 C66 C67 ,68 C67 ,68 C67 ,68			CF92FV1H223J CQ93FM1H472K CQ93FM1H272J CQ93FM1H392J CQ93FM1H392J	MF 0.022UF J MYLAR 0.0047UF K MYLAR 2700PF J MYLAR 3900PF J MYLAR 3900PF J	TE KPUM UEX	
C69 ,70 C69 ,70 C71 -74 C75 C77			CQ93FM1H822J CQ93FM1H822J CE04FW1C100M CK45F1H103Z CK45FF1H223Z	MYLAR 8200PF J MYLAR 8200PF J ELECTR0 10UF 16WV CERAMIC 0.01UF Z CERAMIC 0.022UF Z	KPUM UEX	
C78 C79 -81 C82 C83 ,84 C85			CC45FSL1H150J CK45FF1H223Z CC45FSL1H101J CK45FF1H223Z CQ09FS1H121J	CERAMIC 15PF J CERAMIC 0.022UF Z CERAMIC 100PF J CERAMIC 0.022UF Z POLYSTY 120PF J	TE TE	

E: Scandinavia & Europe H: Audio Club K: USA P: Canada  
 S: South Africa T: England U: PX(Far East, Hawaii)  
 UE: AAFES(Europe) X: Australia M: Other Areas

## PARTS LIST

\* New Parts  
 Parts without Parts No. are not supplied.  
 Les articles non mentionnés dans le Parts No. ne sont pas fournis  
 Teile ohne Parts No. werden nicht geliefert.

Ref. No. 参照番号	Address 位置	New Parts 新	Parts No. 部品番号	Description 部品名 / 規格	Desti- nation 仕 向	Re- marks 備考
C86		*	CC45FCH1H390J	CERAMIC 39PF J	TE	
C87			CQ09FS1H391J	POLYSTY 390PF J		
C88			CK45FF1H223Z	CERAMIC 0.022UF Z		
C89		*	CC45FUJ1H070D	CERAMIC 7.0PF D		
C90			CK14D1H102M	CERAMIC 1000PF M		
C91 -93			CK45FF1H223Z	CERAMIC 0.022UF Z		
C94			CE04FW1C100M	ELECTR0 10UF 16WV		
C95			CK45FF1H223Z	CERAMIC 0.022UF Z		
C96			C91-0083-05	CERAMIC 0.01UF N		
C97			CE04FW1C101M	ELECTR0 100UF 16WV		
C98			CE04FW1H3R3M	ELECTR0 3.3UF 50WV		
C99			CE04FW1V4R7M	ELECTR0 4.7UF 35WV		
C100			CK45FF1H103Z	CERAMIC 0.01UF Z		
C101			CQ93FM1H103K	MYLAR 0.01UF K		
C102			CK45FB1H102K	CERAMIC 0.001UF K		
C103			CQ93FM1H682K	MYLAR 0.0068UF K		
C104			CQ93FM1H222K	MYLAR 2200PF K		
C105			CE04FW1HR47M	ELECTR0 0.47UF 50WV		
C106			CF92FV1H223J	MF 0.022UF J		
C107			CE04FW1HR47M	ELECTR0 0.47UF 50WV		
C108			CQ93FM1H183K	MYLAR 0.018UF K		
C109		*	CE04HW1HOR1M	NP-ELEC 0.1UF 50WV		
C110			CK45FF1H223Z	CERAMIC 0.022UF Z		
C111			CE04HW1HR47M	NP-ELEC 0.47UF 50WV		
C112			CE04GW1H010M	LL-ELEC 1.0UF 50WV		
C113			CE04FW1V330M	ELECTR0 33UF 35WV		
C114			CK45FF1H223Z	CERAMIC 0.022UF Z	TE	
C115			CE04HW1HR47M	NP-ELEC 0.47UF 50WV	TE	
C116			CE04GW1H010M	LL-ELEC 1.0UF 50WV	TE	
C117			CK45FB1H222K	CERAMIC 2200PF K		
C118, 119			CK45FF1H103Z	CERAMIC 0.01UF Z		
C120			CE04FW1A470M	ELECTR0 47UF 10WV		
C121			CE04FW1H010M	ELECTR0 1UF 50WV		
C122			CK45FB1H102K	CERAMIC 0.001UF K		
C123			CK45FF1H103Z	CERAMIC 0.01UF Z		
C124, 125			CE04FW1V4R7M	ELECTR0 4.7UF 35WV		
C126		*	CC45FTH1H120J	CERAMIC 12PF J	TE	
C127			CC45FSL1H221J	CERAMIC 220PF J	TE	
C128			CC45FSL1H101J	CERAMIC 100PF J	TE	
C129			CK45FF1H223Z	CERAMIC 0.022UF Z	TE	
C130			CK45FF1H103Z	CERAMIC 0.01UF Z	TE	
C131		*	CE04FW0J222M	ELECTR0 2200UF 6.3WV		
C132			CK45FF1H223Z	CERAMIC 0.022UF Z		
C133			CK45FF1H103Z	CERAMIC 0.01UF Z		
C134, 135			CC45FCH1H330J	CERAMIC 33PF J	KPUM	
C134, 135			CC45FCH1H330J	CERAMIC 33PF J	UEX	
C136		*	R90-0544-05	MULTI-C0		
C137			C91-0083-05	CERAMIC 0.01UF N		
C138, 139			CE04FW1H2R2M	ELECTR0 2.2UF 50WV		
C140			CE04FW1A470M	ELECTR0 47UF 10WV		
C141			CE04FW1C100M	ELECTR0 10UF 16WV		
C142			CE04FW1V100M	ELECTR0 10UF 35WV		
C143			CE04FW1A101M	ELECTR0 100UF 10WV		
C144			CE04FW1C220M	ELECTR0 22UF 16WV		
C145			CE04FW1HR47M	ELECTR0 0.47UF 50WV		

E: Scandinavia & Europe H: Audio Club K: USA P: Canada  
 S: South Africa T: England U: PX(Far East, Hawaii)  
 [UE]: AAFES(Europe) X: Australia M: Other Areas

## PARTS LIST

\* New Parts

Parts without Parts No. are not supplied.

Les articles non mentionnés dans le Parts No. ne sont pas fournis.

Teile ohne Parts No. werden nicht geliefert.

Ref. No. 参照番号	Address 位置	New Parts 新	Parts No. 部品番号	Description 部品名 / 規格	Desti- nation 仕向	Re- marks 備考
C146 C147-152 C153 C154 C155			CE04FW1C101M CK45FF1H103Z C91-0083-05 CK45FF1H103Z CQ93FM1H472K	ELECTRO 100UF 16WV CERAMIC 0.01UF Z CERAMIC 0.01UF N CERAMIC 0.01UF Z MYLAR 0.0047UF K		
CT1 -4 CT5 CT6 CT7 ,8 CT9			C05-0302-05 C05-0301-05 C05-0303-05 C05-0303-05 C05-0302-05	CERAMIC TRIM CAPACITOR (11PF) CERAMIC TRIM CAPACITOR (7PF) CERAMIC TRIM CAPACITOR (20PF) CERAMIC TRIM CAPACITOR (20PF) CERAMIC TRIM CAPACITOR (11PF)	KPUM TE	
CT10		*	C05-0093-05	CERAMIC TRIM CAPACITOR (10PF)	TE	
101 -	1B		E13-0217-05 E23-0125-05	PHONE JACK TERMINAL (GND PLATE)		
CF1 CF1 CF1 CF2 CF2		*	L72-0195-05 L72-0505-05 L72-0505-05 L72-0185-05 L72-0185-05	CERAMIC FILTER (MJGH15-A) CERAMIC FILTER (MP3H15-A) CERAMIC FILTER (MP3H15-A) CERAMIC FILTER (MXH15-A) CERAMIC FILTER (MXH15-A)	TE KPUM UEX KPUM UEX	
CF2 CF3 CF4 L1 L2		*	L72-0190-05 L72-0097-05 L72-0096-05 L31-0495-05 L31-0492-05	CERAMIC FILTER (MS3GH15-A) CERAMIC FILTER CERAMIC FILTER FM-RF COIL FM-RF COIL	TE	
L3 L4 L5 L6 ,7 L8		*	L31-0495-05 L40-1092-14 L30-0247-05 L32-0270-05 L30-0282-05	FM-RF COIL SMALL FIXED INDUCTOR (1.0UH,M) FM IFT FM OSCILLATING COIL FM IFT		
L10 L11 L12 L13 ,14 L15		*	L30-0361-15 L30-0341-05 L32-0275-05 L40-1001-14 L79-0162-05	FM IFT FM IFT FM OSCILLATING COIL SMALL FIXED INDUCTOR (10UH,K) LC FILTER (LPF)		
L16 L17 L18 L19 L20			L35-0059-05 L79-0101-05 L40-1092-14 L31-0472-05 L31-0479-05	MPX COIL LC FILTER (LPF) SMALL FIXED INDUCTOR (1.0UH,M) MW-RF COIL LW-RF COIL	TE	
L21 L22 L23 L24 X1			L32-0278-05 L79-0074-05 L32-0277-15 L30-0337-05 L77-0578-05	LW OSCILLATING COIL LC FILTER (LPF) MW OSCILLATING COIL AM IFT CRYSTAL RESONATOR (7.2MHZ)	TE TE	
X2 X2			L77-0578-05 L77-0578-05	CRYSTAL RESONATOR (7.2MHZ) CRYSTAL RESONATOR (7.2MHZ)	KPUM UEX	
R2 R2 R26 R28 R31			RC05GF2H185M RC05GF2H185M RD14GB2E270J RD14GB2E101J RD14GB2E101J	RC 1.8M M 2H RC 1.8M M 2H FL-PROOF RD 27 J 2E FL-PROOF RD 100 J 2E FL-PROOF RD 100 J 2E	KPUM UEX	
R40 R43 ,44 R72		*	RD14GB2E101J RD14GB2E101J RN14BK2E1802G	FL-PROOF RD 100 J 2E FL-PROOF RD 100 J 2E RN 18 2 2E		

E: Scandinavia & Europe H: Audio Club K: USA

P: Canada

S: South Africa T: England U: PX(Far East, Hawaii)

UE: AAFES(Europe) X: Australia M: Other Areas

# PARTS LIST

\* New Parts  
 Parts without Parts No. are not supplied.  
 Les articles non mentionnes dans le Parts No. ne sont pas fournis.  
 Teile ohne Parts No. werden nicht geliefert.

Ref. No. 参照番号	Address 位置	New Parts 新	Parts No. 部品番号	Description 部品名 / 規格	Desti- nation 仕 向	Re- marks 備考
R84			RD14GB2E270J	FL-PROOF RD 27 J 2E		
R85			RD14GB2E101J	FL-PROOF RD 100 J 2E		
R123			RD14GB2E101J	FL-PROOF RD 100 J 2E		
R128			RD14GB2E270J	FL-PROOF RD 27 J 2E		
R138			RD14GB2E101J	FL-PROOF RD 100 J 2E		
R179			RD14GB2E101J	FL-PROOF RD 100 J 2E		
R195			RD14GB2E101J	FL-PROOF RD 100 J 2E	TE	
R205			RD14GB2E470J	FL-PROOF RD 47 J 2E		
R222		*	R90-0245-05	MULTI-COMP 56K X13		
R223		*	R90-0246-05	MULTI-COMP		
VR1			R12-1312-05	TRIMMING POT(1K) IF GAIN		
VR2			R12-5310-05	TRIMMING POT(200K) DISTORTION		
VR3			R12-2024-05	TRIMMING POT(6.8K) VCO		
VR4			R12-3313-05	TRIMMING POT(20K) PILOT SIG		
VR5 ,6			R12-5309-05	TRIMMING POT(100K) SEPARATION		
VR7		*	R13-5041-05	VARIABLE RESISTOR AM IF BAND		
S1 -4			S40-1068-05	PUSH SWITCH (MODE, MEM, TUNING)		
S5 ,6			S40-1068-05	PUSH SWITCH (LW, FM)	TE	
S6 ,7			S40-1068-05	PUSH SWITCH (FM, AM)	KPUM	
S6 ,7			S40-1068-05	PUSH SWITCH (FM, AM)	UEX	
S8			S40-1068-05	PUSH SWITCH (MW)	TE	
S9 -14			S40-1068-05	PUSH SWITCH (M1-6)		
S15 ,16			S31-2072-05	SLIDE SWITCH(DE-EMPH, CH SPACE)	KPUM	
S15 ,16			S31-2072-05	SLIDE SWITCH(DE-EMPH, CH SPACE)	UEX	
D6 -9			M8513A-0	VARISTOR		
D10 ,11			1N60	DIODE		
D12			KV1226(Y)	VARIABLE CAPACITANCE DIODE		
D13			1S1555	DIODE		
D13			1S2076	DIODE		
D14			R08. 2J(B2)	ZENER DIODE		
D15			1S1555	DIODE		
D15			1S1555	DIODE	KPUM	
D15			1S2076	DIODE	UEX	
D15			1S2076	DIODE	KPUM	
D15			1S2076	DIODE	UEX	
D15 -18			1S1555	DIODE	TE	
D15 -18			1S2076	DIODE	TE	
D17 ,18			1S1555	DIODE	KPUM	
D17 ,18			1S1555	DIODE	UEX	
D17 ,18			1S2076	DIODE	KPUM	
D17 ,18			1S2076	DIODE	UEX	
D19			KV1226(EF)	VARIABLE CAPACITANCE DIODE		
D19			KV1226(X)	VARIABLE CAPACITANCE DIODE		
D20			KV1226(EF)	VARIABLE CAPACITANCE DIODE	TE	
D20			KV1226(X)	VARIABLE CAPACITANCE DIODE	TE	
D21 -25			1S1555	DIODE	TE	
D21 -25			1S2076	DIODE	TE	
D21 ,22			1S1555	DIODE	KPUM	
D21 ,22			1S1555	DIODE	UEX	
D21 ,22			1S2076	DIODE	KPUM	
D21 ,22			1S2076	DIODE	UEX	
D24 ,25			1S1555	DIODE	KPUM	
D24 ,25			1S1555	DIODE	UEX	
D24 ,25			1S2076	DIODE	KPUM	
D24 ,25			1S2076	DIODE	UEX	

E: Scandinavia & Europe H: Audio Club K: USA P: Canada  
 S: South Africa T: England U: PX(Far East, Hawaii)  
 UE: AAFES(Europe) X: Australia M: Other Areas

## PARTS LIST

\* New Parts  
 Parts without Parts No. are not supplied.  
 Les articles non mentionnés dans le Parts No. ne sont pas fournis.  
 Teile ohne Parts No. werden nicht geliefert.

Ref. No. 参照番号	Address 位置	New Parts 新	Parts No. 部品番号	Description 部品名 / 規格	Desti- nation 仕 向	Re- marks 備考
D26			RD5.1E(B3)	ZENER DIODE		
D27 ,28			1S1555	DIODE		
D27 ,28			1S2076	DIODE		
D29			RD11E(B3)	ZENER DIODE		
D30 -32			1S1555	DIODE		
D30 -32			1S2076	DIODE		
D49			1S1555	DIODE		
D49			1S2076	DIODE		
DV1 -5			KV1320-5	VARIABLE CAPACITANCE DIODE		
FL1			FIP7B8S	FLUORESCENT INDICATOR TUBE		
IC1			LA1222	IC (OP AMP)		
IC2			LA1231NS	IC (FM IF SYSTEM)		
IC3			UPC1163H	IC (OP AMP)		
IC4 ,5			NJM4560D-N	IC (OP AMP)		
IC6			UPC1223C	IC (MPX)		
IC7			LA1245	IC (AM)		
IC8			TD6104P	IC (FM PRESCALER)		
IC9			AN6135	IC (MUTING)		
IC10			UPD4011BC	IC (NAND GATE)		
IC11			TC9157P	IC (DIGITAL TUNING SYSTEM)		
IC12			AN6876	IC (S-METER DRIVER)		
IC13			TD6301AP	IC (FIP DRIVER)		
Q1 ,2			3SK73(GR)	FET		
Q3			2SK161(Y,GR)	FET		
Q4		*	2SC461(B,C)	TRANSISTOR		
Q5		*	2SK241(GR)	FET		
Q6 ,7			2SK161(Y,GR)	FET		
Q8 ,9		*	2SK105(F,H)	FET		
Q10			2SC2320(E,F)	TRANSISTOR	TE	
Q10			2SC945(A)(Q,P)	TRANSISTOR	TE	
Q11			2SK161(Y,GR)	FET	TE	
Q12			2SC2320(E,F)	TRANSISTOR	TE	
Q12			2SC945(A)(Q,P)	TRANSISTOR	TE	
Q13 ,14			2SK163(L,M)	FET	TE	
Q15			2SK161(Y,GR)	FET		
Q16			2SK105(H)	FET		
Q17			2SK105(H,J)	FET		
Q18			2SC2320(E,F)	TRANSISTOR		
Q18			2SC945(A)(Q,P)	TRANSISTOR		
Q19			2SK105(H,J)	FET	TE	
Q20			2SC2320(E,F)	TRANSISTOR	TE	
Q20			2SC945(A)(Q,P)	TRANSISTOR	TE	
Q21			2SA733(A)(Q,P)	TRANSISTOR	TE	
Q21			2SA999(E,F)	TRANSISTOR	TE	
Q22			2SC2320(E,F)	TRANSISTOR	TE	
Q22			2SC945(A)(Q,P)	TRANSISTOR	TE	
Q23			2SB764(E,F)	TRANSISTOR		
Q24			2SC2320(E,F)	TRANSISTOR		
Q24			2SC945(A)(Q,P)	TRANSISTOR		
Q25			2SB764(E,F)	TRANSISTOR		
Q26 -32			2SC2320(E,F)	TRANSISTOR		
Q26 -32			2SC945(A)(Q,P)	TRANSISTOR		
Q33 -35			2SA733(A)(Q,P)	TRANSISTOR	TE	
Q33 -35			2SA999(E,F)	TRANSISTOR	TE	
Q33 ,34			2SA733(A)(Q,P)	TRANSISTOR	KPUM	

E: Scandinavia & Europe H: Audio Club K: USA P: Canada  
 S: South Africa T: England U: PX(Far East, Hawaii)  
 UE: AAFES(Europe) X: Australia M: Other Areas



## PARTS LIST

\* New Parts  
 Parts without **Parts No.** are not supplied.  
 Les articles non mentionnés dans le **Parts No.** ne sont pas fournis.  
 Teile ohne **Parts No.** werden nicht geliefert.

Ref. No. 参照番号	Address 位置	New Parts 新	Parts No. 部品番号	Description 部品名 / 規格	Desti- nation 仕 向	Re- marks 備考
Q33 ,34			2SA733(A) (Q,P)	TRANSISTOR	UEX	
Q33 ,34			2SA999(E,F)	TRANSISTOR	KPUM	
Q33 ,34			2SA999(E,F)	TRANSISTOR	UEX	
Q36		*	2SC461(B,C)	TRANSISTOR	TE	
Q37			2SC2320(E,F)	TRANSISTOR		
Q37			2SC945(A) (Q,P)	TRANSISTOR		
Q38 ,39			2SA733(A) (Q,P)	TRANSISTOR		
Q38 ,39			2SA999(E,F)	TRANSISTOR		
Q40 -43			2SC2320(E,F)	TRANSISTOR		
Q40 -43			2SC945(A) (Q,P)	TRANSISTOR		

E: Scandinavia & Europe H: Audio Club K: USA P: Canada  
 S: South Africa T: England U: PX(Far East, Hawaii)  
 UE: AAFES(Europe) X: Australia M: Other Areas

## WORLD MAP & AREA CODE

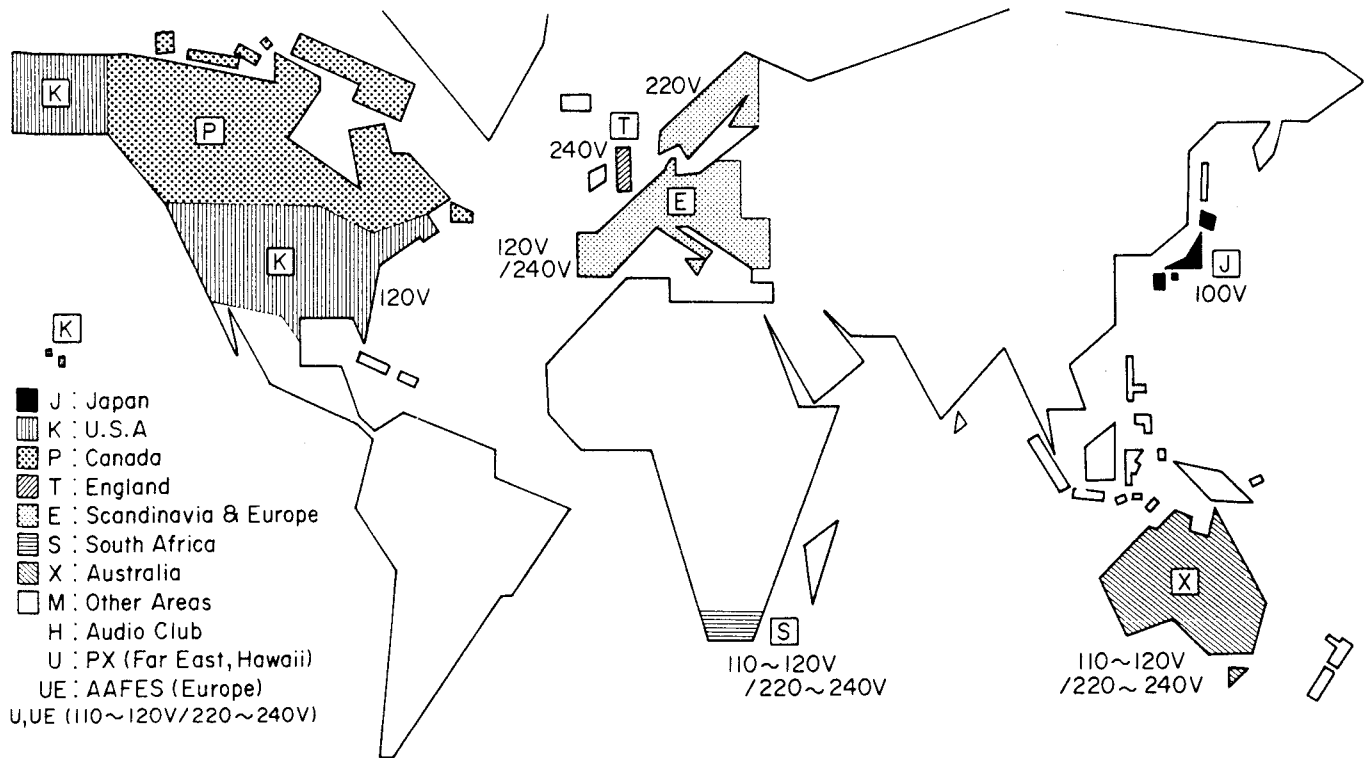

### Note:

Component and circuitry are subject to modification to insure best operation under differing local conditions. This manual is based on, the U.S. (K) standard, and provides information on regional circuit modification through use of alternate schematic diagrams, and information on regional component variations through use of parts list.

## TRIO-KENWOOD CORPORATION

Shionogi Shibuya Building, 17-5, 2-chome Shibuya, Shibuya-ku, Tokyo 150, Japan

### KENWOOD ELECTRONICS

1315 E. Watsoncenter Rd, Carson, California 90745, U.S.A.  
 75 Seaview Drive, Secaucus, New Jersey 07094, U.S.A.

### TRIO-KENWOOD CANADA INC.,

1070 Jayson Court, Mississauga, Ontario, Canada L4W 2V5

### TRIO-KENWOOD ELECTRONICS, N.V.

Leuvensesteenweg 504 B-1930 Zaventem, Belgium

### TRIO-KENWOOD ELECTRONICS GmbH

Rudolf-Brass-Str. 20, 6056 Heusenstamm, West Germany

### TRIO-KENWOOD FRANCE S.A.

5, Boulevard Ney, 75018 Paris, France

### TRIO-KENWOOD (AUSTRALIA) PTY. LTD. (INCORPORATED IN N.S.W.)

4E Woodcock Place, Lane Cove, N.S.W. 2066, Australia

### KENWOOD & LEE ELECTRONICS, LTD.

Wang Kee Building, 5th Floor, 34-37, Connaught Road, Central, Hong Kong