



# LA4500

## 5.3W 2-Channel AF Power Amplifier

### Features

- Low idling current (20mA/2 channels) enabling prolonged battery life.
- Less dependence of idling current on  $V_{CC}$ .
- High power (5.3W typ.  $\times 2$ ).
- High ripple rejection (60dB at steady state).  
Since filters are arranged in 3 stages (including 1 stage inside the IC) to attain satisfactory ripple rejection at transient state, ripple occurring at the time of motor start can be prevented from mixing in.
- Low pop noise at the time of power supply ON/OFF and good starting balance between both channels (0.6s.) due to built-in pop noise limiter.
- Pins provided for compensating high frequency response.
- Low residual noise (0.4mV).
- Wide supply voltage range (6 to 24V) facilitating design of transformer power supply.
- Built-in thermal shutdown circuit,
- Designed so that inverse insertion or short between adjacent pins causes no destruction.
- Channel-to channel mirror image pin assignment and provision of Pre GND, Power GND pins enabling stable operation and facilitating artwork of printed circuit board.
- Minimum number of external parts required (9pcs. min., 12pcs. typ.).
- Audio muting capability (for automatic music selection, electronic tuner).

### Package Dimensions

unit:mm

3037A-DIP20H

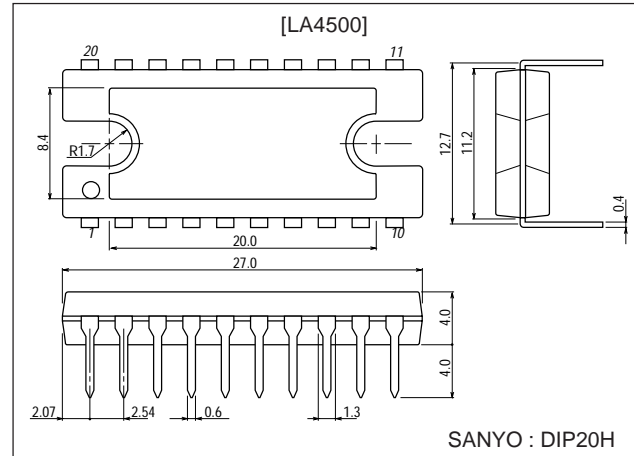

### Specifications

**Absolute Maximum Ratings** at  $T_a = 25^\circ\text{C}$ 

Parameter	Symbol	Conditions	Ratings	Unit
Maximum supply voltage	$V_{CC}$ max		24	V
Maximum output current	$I_O$ peak	1 channel	2.5	A
Allowable power dissipation	$P_d$ max	With infinite heat sink	15	W
Operating temperature	$T_{opr}$		-20 to +75	$^\circ\text{C}$
Storage temperature	$T_{stg}$		-40 to +150	$^\circ\text{C}$

■ Any and all SANYO products described or contained herein do not have specifications that can handle applications that require extremely high levels of reliability, such as life-support systems, aircraft's control systems, or other applications whose failure can be reasonably expected to result in serious physical and/or material damage. Consult with your SANYO representative nearest you before using any SANYO products described or contained herein in such applications.

■ SANYO assumes no responsibility for equipment failures that result from using products at values that exceed, even momentarily, rated values (such as maximum ratings, operating condition ranges, or other parameters) listed in products specifications of any and all SANYO products described or contained herein.

**SANYO Electric Co., Ltd. Semiconductor Company**

TOKYO OFFICE Tokyo Bldg., 1-10, 1 Chome, Ueno, Taito-ku, TOKYO, 110-8534 JAPAN

# LA4500

## Recommended Operating Conditions at $T_a = 25^\circ\text{C}$

Parameter	Symbol	Conditions	Ratings	Unit
Supply voltage	$V_{CC}$		12	V
Load resistance	$R_L$	Stereo	3	$\Omega$

## Operating Characteristics at $T_a = 25^\circ\text{C}$ , $V_{CC}=12\text{V}$ , $R_L=3\Omega$ (stereo), $f=1\text{kHz}$ , $R_g=600\Omega$ , See specified test circuit.

Parameter	Symbol	Conditions	Ratings			Unit
			min	typ	max	
Quiescent current	$I_{CCO}$	Stereo	10	20	30	mA
Voltage gain	VG		48	50	52	dB
Voltage gain difference	$\Delta VG$	Channel 1, 2			$\pm 1$	dB
Output power	$P_O$	THD=10%	4.5	5.3		W
Total harmonic distortion	THD	$V_O=2\text{V}$		0.3	1.5	%
Input resistance	$r_i$			30		k $\Omega$
Output noise voltage	$V_{NO1}$	$R_g=0$ , $f=20\text{Hz}$ to $20\text{kHz}$ , Band-pass filter		0.4	1.0	mV
	$V_{NO2}$	$R_g=10\text{k}\Omega$ , $f=20\text{Hz}$ to $20\text{kHz}$ , Band-pass filter		0.6	2.0	mV
Ripple rejection	$R_r$	$R_g=0$ , $f_R=100\text{Hz}$ , $V_R=0\text{dBm}$	50	60		dB
Channel separation	ch sep	$R_g=10\text{k}\Omega$ , $V_o=0\text{dBm}$	45	55		dB

## Equivalent Circuit Block Diagram

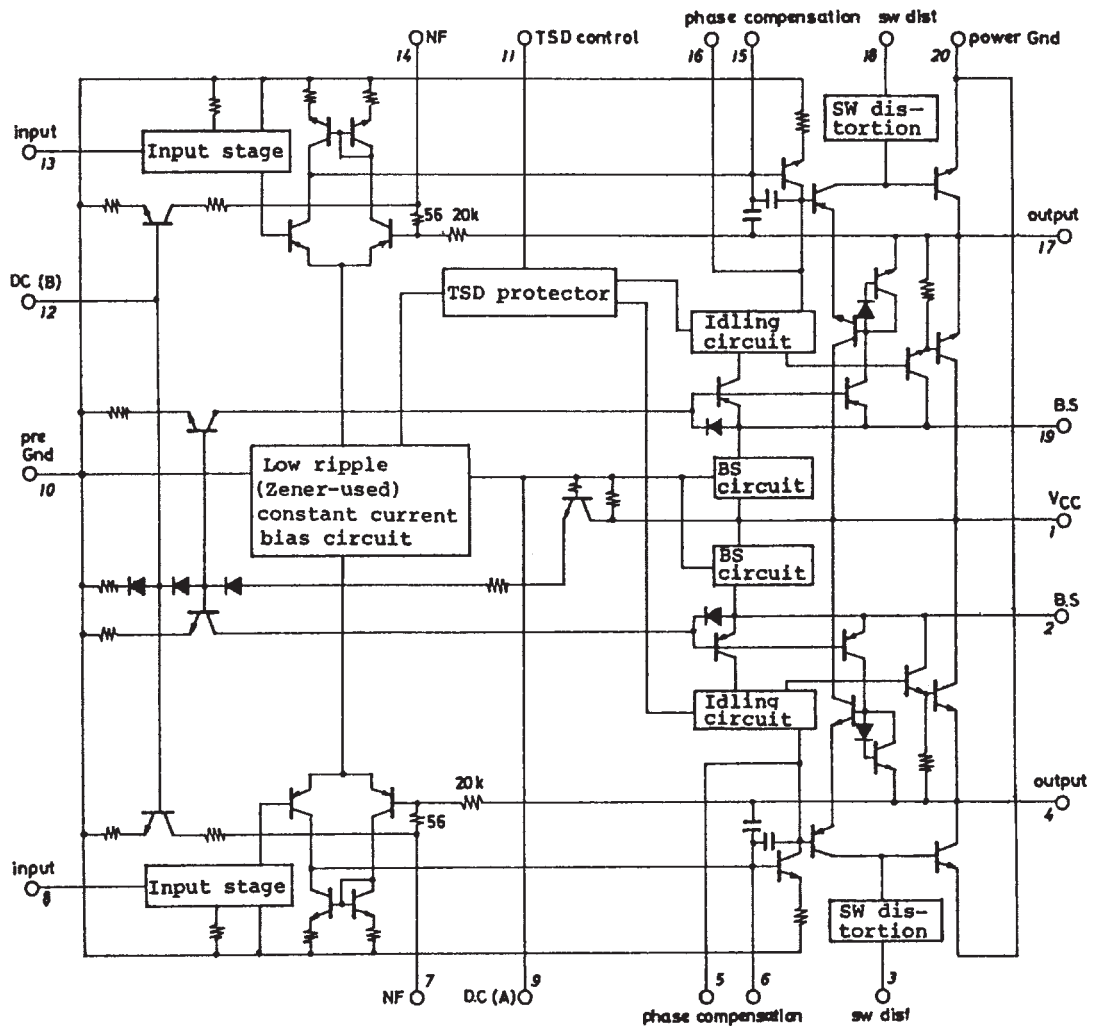

# LA4500

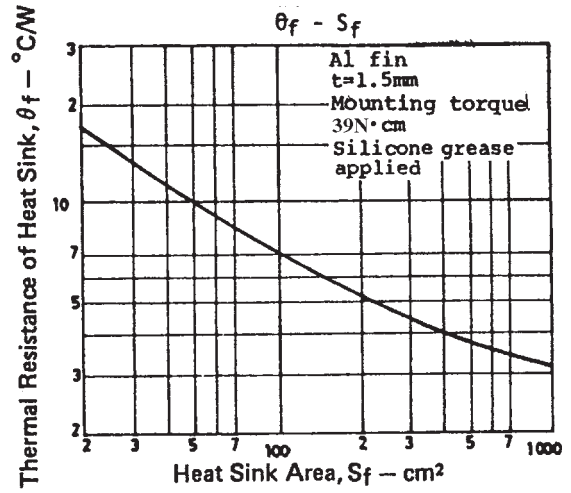
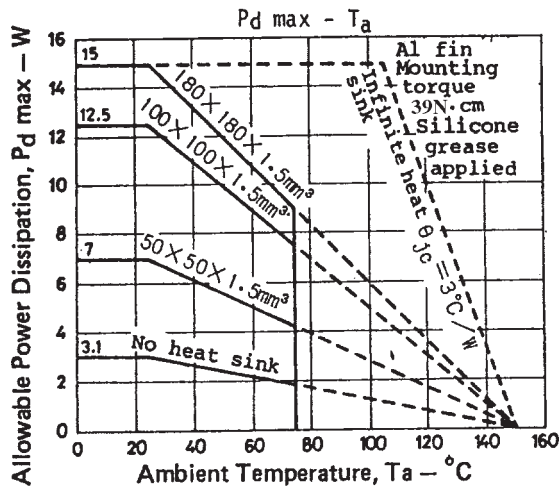

Sample Application Circuit 1

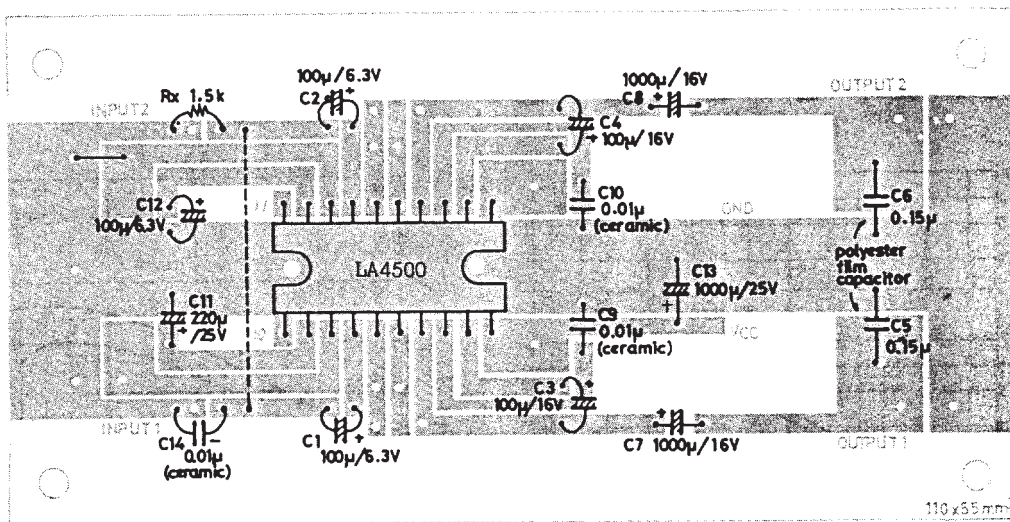
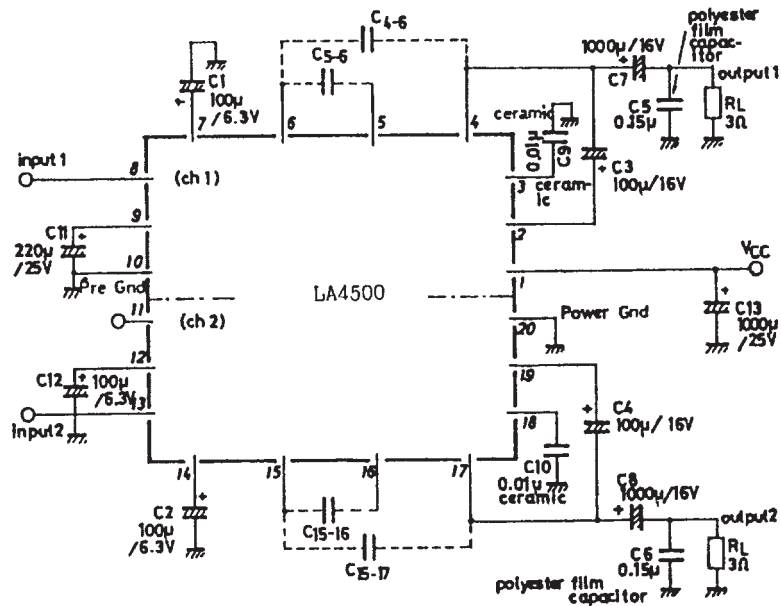

### Description of External Parts

- C1 (C1) Feedback capacitors  
Related to low roll-off frequency  $f_L$  for  $-3\text{dB}$  ( $100\mu\text{F}$ ,  $f_L=60\text{Hz}$ ).  
A capacitance value of  $47\mu\text{F}$  to  $100\mu\text{F}$  is recommended. Increasing the capacitance value makes the starting time ( $t_s$ ) later. Decreasing the capacitance value makes the starting time ( $t_s$ ) earlier.
- C3 (C4) Bootstrap capacitors  
Decreasing the capacitance value lowers output at low frequencies. A capacitance value of  $47\mu\text{F}$  to  $100\mu\text{F}$  is recommended.
- C5 (C6) Oscillation blocking capacitors  
Polyester film capacitor, being excellent in temperature characteristic, frequency characteristics, is recommended.
- C7 (C8) Output capacitors  
Related to low roll-off frequency and output at low frequencies. BTL applications normally require output capacitors.
- C9 (C10) Switching distortion compensating capacitors  
Compensates switching distortion which occurs at a high frequency of  $10\text{kHz}$ . Ceramic capacitor of  $0.01\mu\text{F}$  is recommended. If no problem arises in terms of radio-cassette recorder design or tone, it is unnecessary to use these capacitors.
- C11 Filter capacitor (A)  
Ripple filter circuit provided in power supply line. A capacitance value of  $220\mu\text{F}$  is recommended. Ripple rejection SVRR starts to be saturated at  $47\mu\text{F}$ . The starting time and pop noise generated at the time of power supply ON must be considered when fixing the capacitance value. A capacitance value of  $100\mu\text{F}$  to  $220\mu\text{F}$  is usable.
- C12 Filter capacitor (B)  
Ripple filter circuit provided in bias circuit. A capacitance value of  $100\mu\text{F}$  is recommended.  $3\text{V}$  suffices the breakdown voltage of this capacitor. This capacitor is for ripple rejection at transient state and rejects noise "buzz" generated when the above-mentioned filter circuit provided in power supply line is saturated due to large ripple and supply voltage drop induced at the time of start of the motor connected to power supply line. If the motor is satisfactory in performance and the power supply regulation including ripple is  $500\text{mVrms}$  or less, it is unnecessary to use this capacitor. If noise "buzz" is not offensive to the ear, it is unnecessary to use this capacitor. In this case, other basic performances are not affected adversely.

### Features of IC Contents and Functions of Other Pins

- (a) Since the input circuit uses PNP transistors and the bias voltage is set nearly equal to 0, no input coupling capacitor is required, thereby enabling direct coupling. However, if slider contact noise of the variable resistor presents any problem, connect a capacitor in series with input.
- (b) Various ideas embodied in the idling circuit enable reduced  $I_{\text{CCO}}$  and prolonged battery life. Since the non-operating level of the idling circuit is made equal to that of the amplifier, crossover distortion does not worsen at the time of reduced voltage.
- (c) The open loop voltage gain is lowered and the negative feedback amount is made small to assure stable operation. Radiation to the radio-frequency stage is made less by soft clipping.
- (d) Capacitors for oscillation compensation are contained as a means of reducing the number of external parts.  $10\text{pF}\times 2$  and  $2\text{pF}\times 2$  are used. High roll-off frequency  $f_H$  ( $-3\text{dB}$  point) depends on these capacitance values. ( $f_H=28\text{kHz}$ )
- (e) A thermal shutdown (THD) circuit is contained to prevent the IC from being destroyed by abnormal heat generation attributable to insufficient heat dissipation. Pin (11) is used as THD control pin. Biasing pin (11) externally makes the operating temperature lower; and connecting a resistor across pin (11) and (10) makes the operating temperature higher. If pin (11) is connected to GND, the thermal shutdown circuit stops operating.
- (f) The pin assignment is carefully considered so that no destruction takes place even if power supply is applied at a state where adjacent pins are shorted by solder bridge, etc. Even  $180^\circ\text{C}$ -rotated insertion causes no destruction.
- (g) Collector pins (5), (16) and base pins (6), (15) for predrive can be conveniently used in applications. For oscillation compensation occurring when operated at a lowered gain, connect a capacitor across the pins (4) and (6) and a capacitor across pins (15) and (16). For  $f_H$  compensation occurring when operated at a lowered gain, connect a capacitor across pins (4) and (6) and a capacitor across pins (17) and (15). Further soft clipping and prevention of waveform distortion at high frequencies are attained by connecting a series circuit of diode (DS442) and resistor ( $10\text{k}\Omega$ ) across pin (6) and GND and the same across pin (15) and GND.

Continued on next page.

# LA4500

Continued from preceding page.

- (h) Feedback resistance  $R_{NF}$  is contained and the voltage gain is fixed at 50dB so that the variations in the voltage gain can be minimized. The gain can be lowered by connecting  $R_{NF}$  externally.

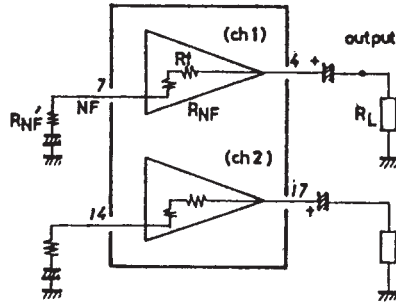

- (i) Biasing pin (12) as shown below causes DC audio muting to be applied, thereby cutting off the IC. This makes attack time, recovery time, pop noise, etc. satisfactory. It is recommended that the following method be used to control the NF pin.

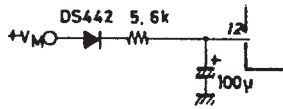

It is recommended that the following method be used to control the NF pin.

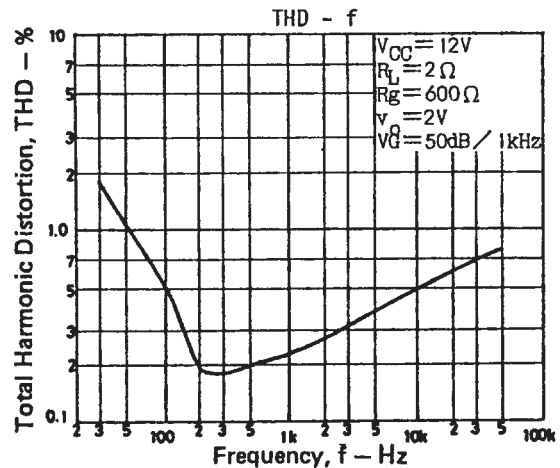
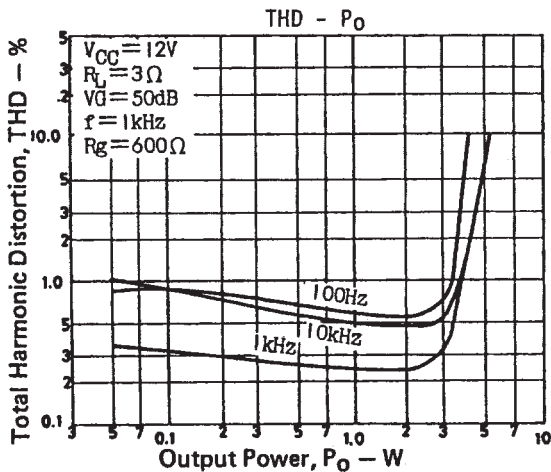
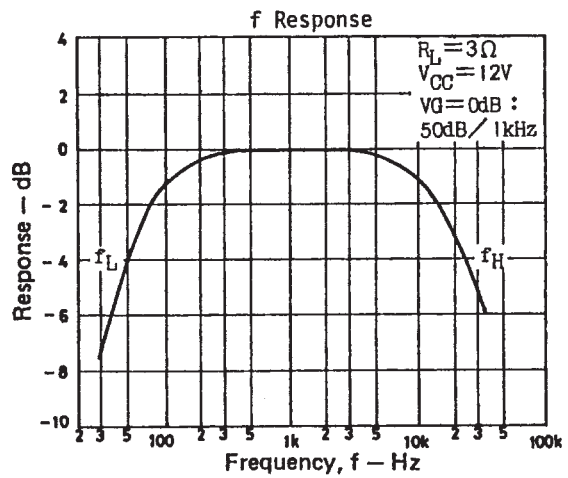
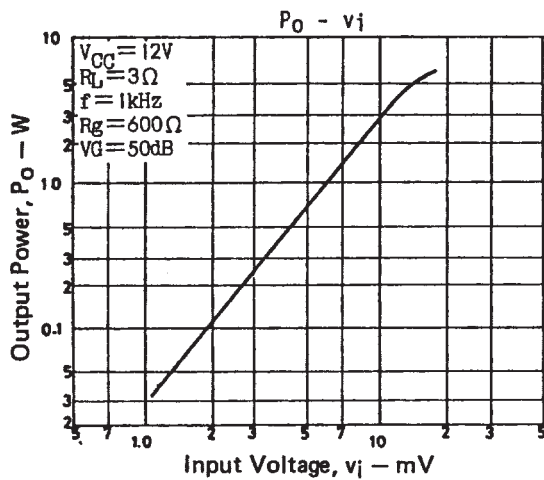
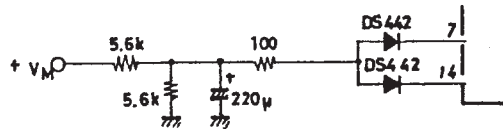



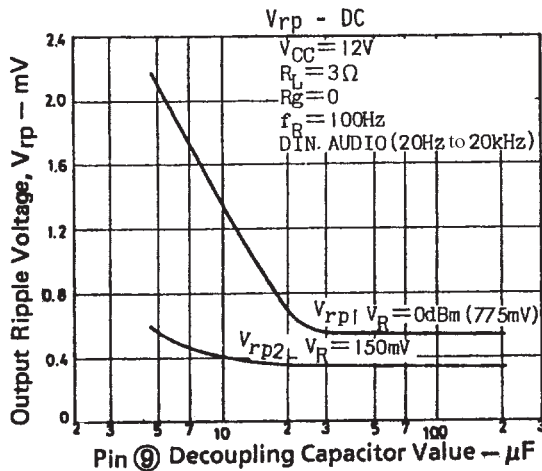
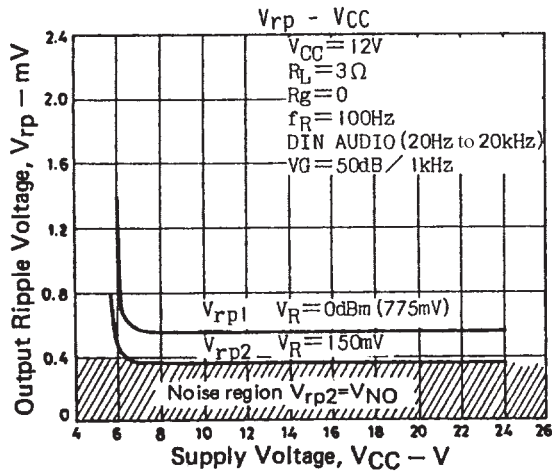
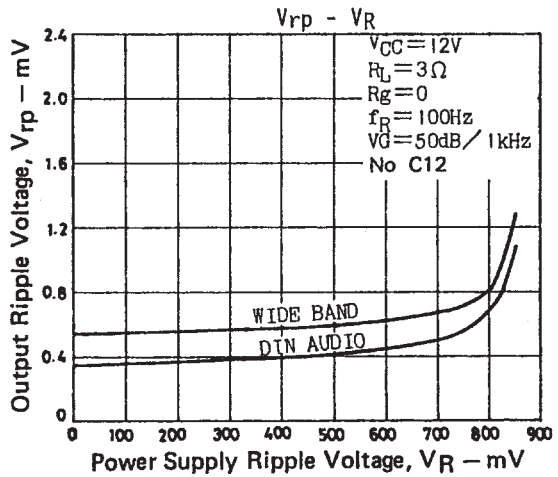
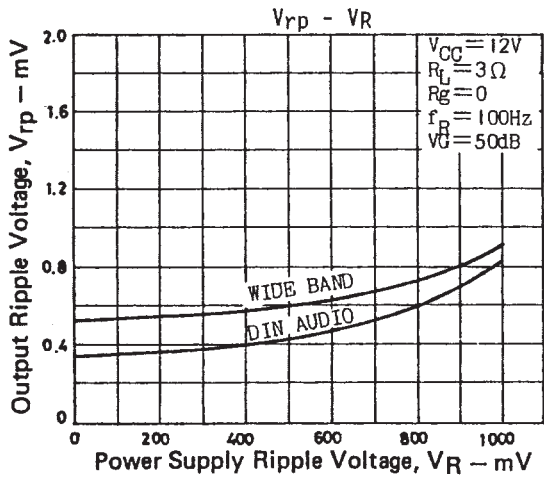
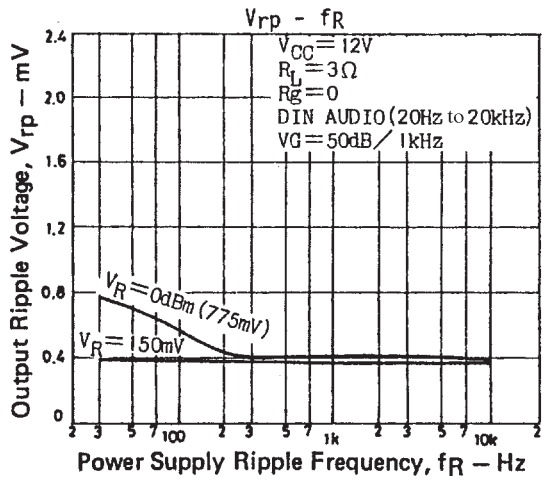
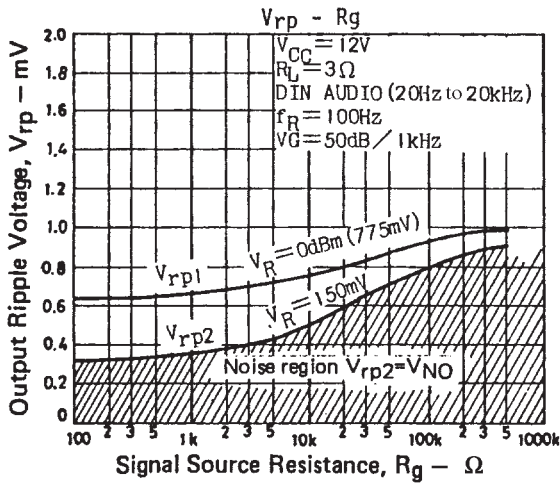
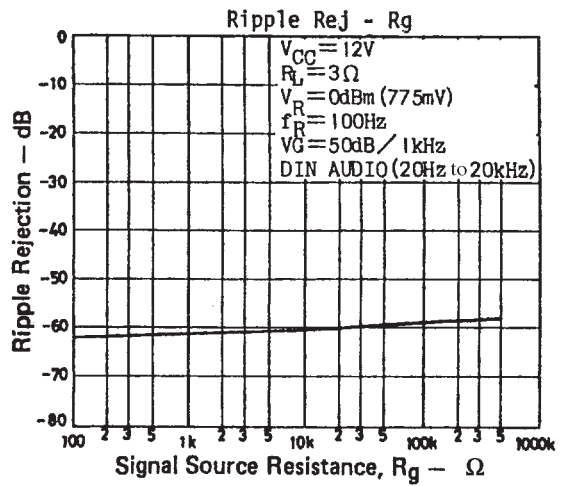
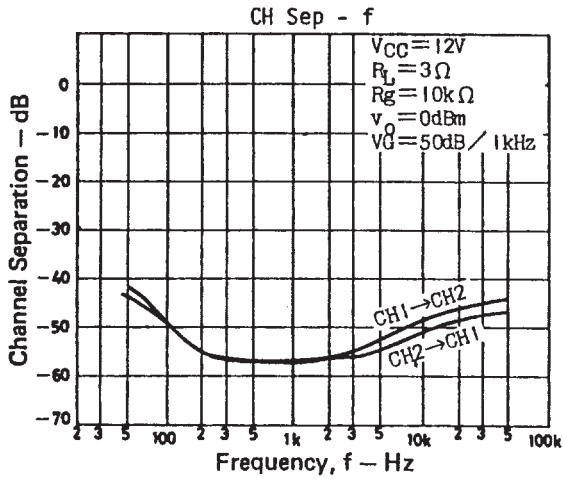

# LA4500

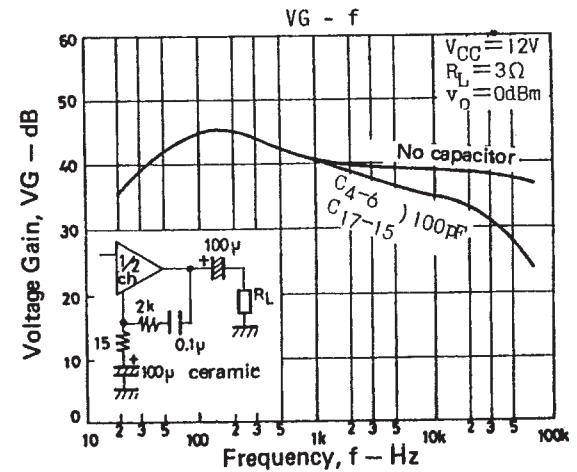
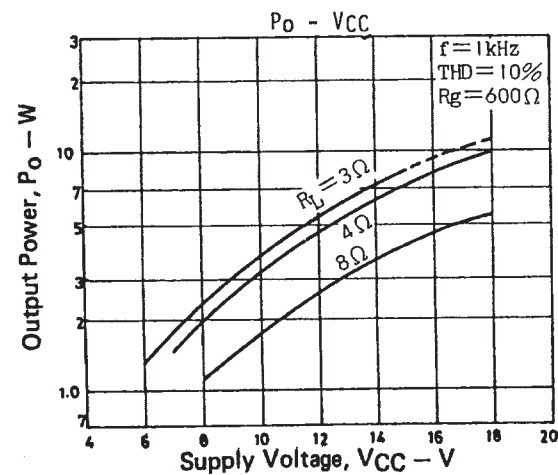
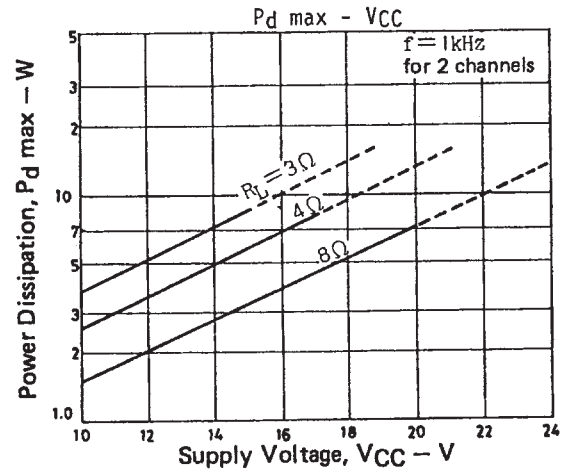
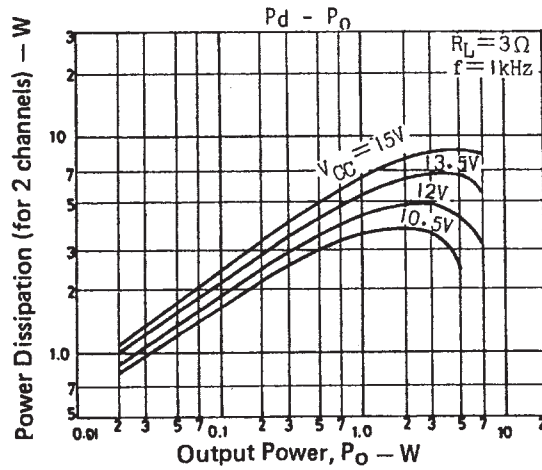
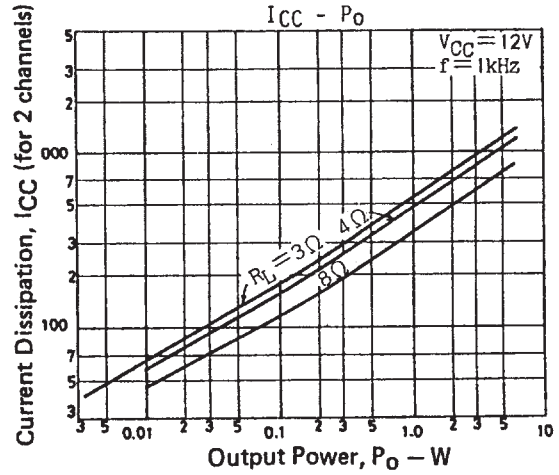
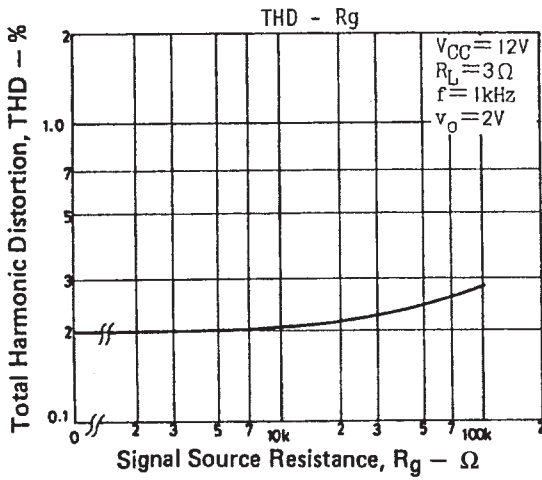
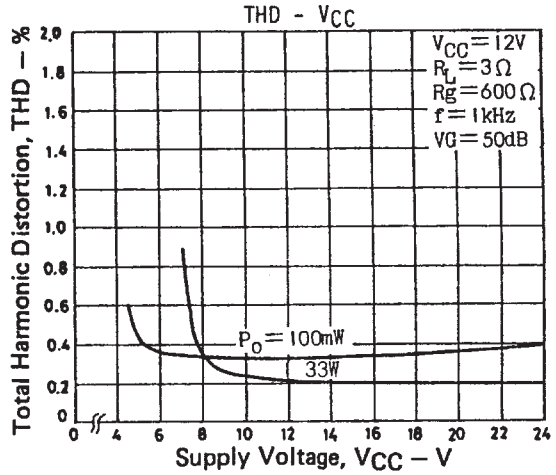
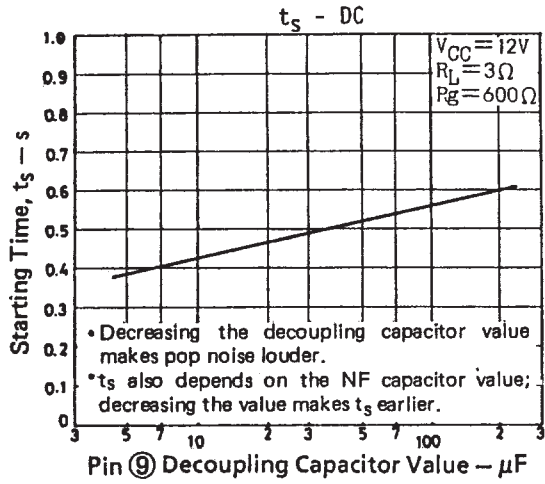

# LA4500

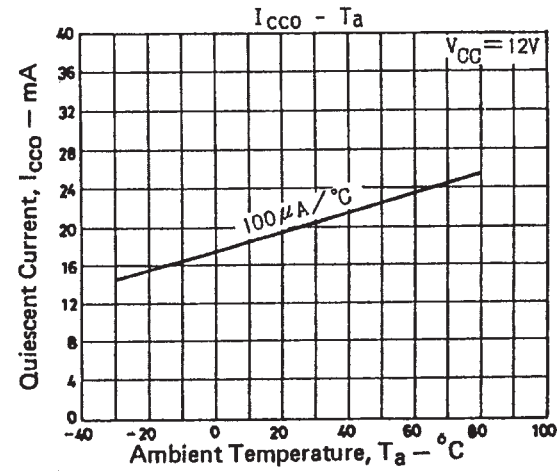
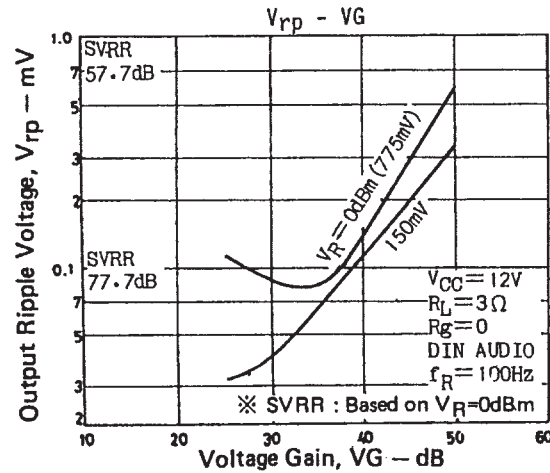
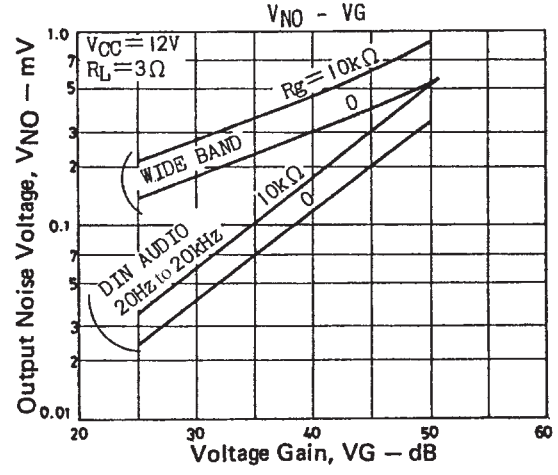
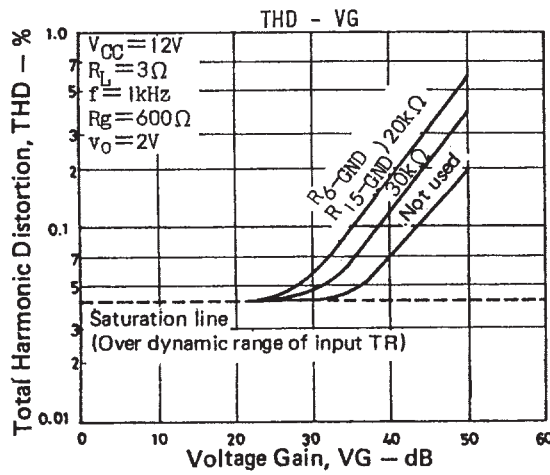
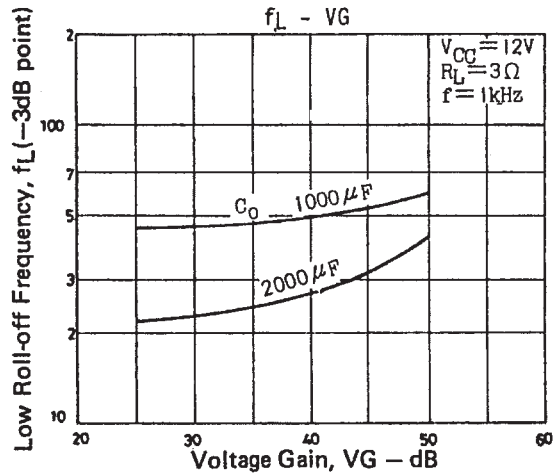
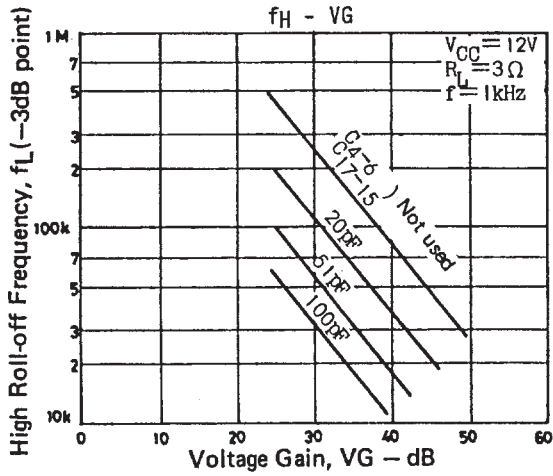
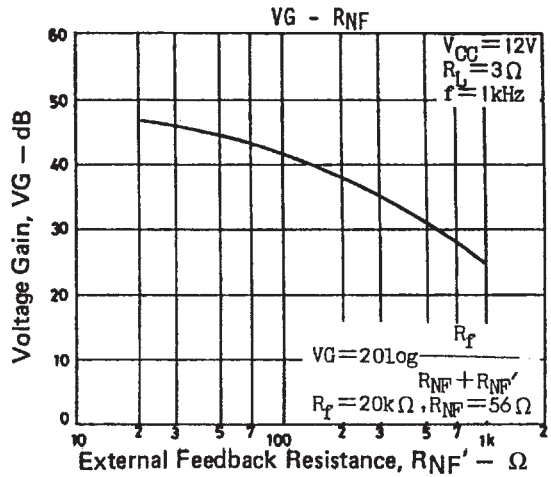
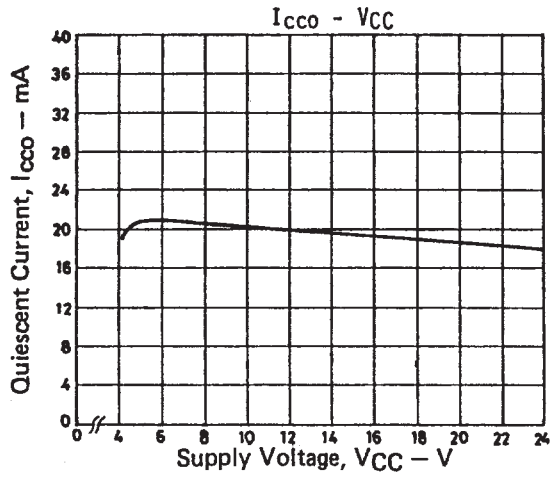



# LA4500

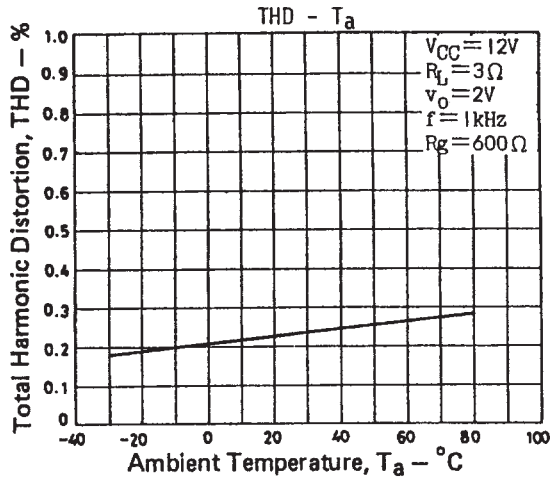

## Sample Application Circuit 2

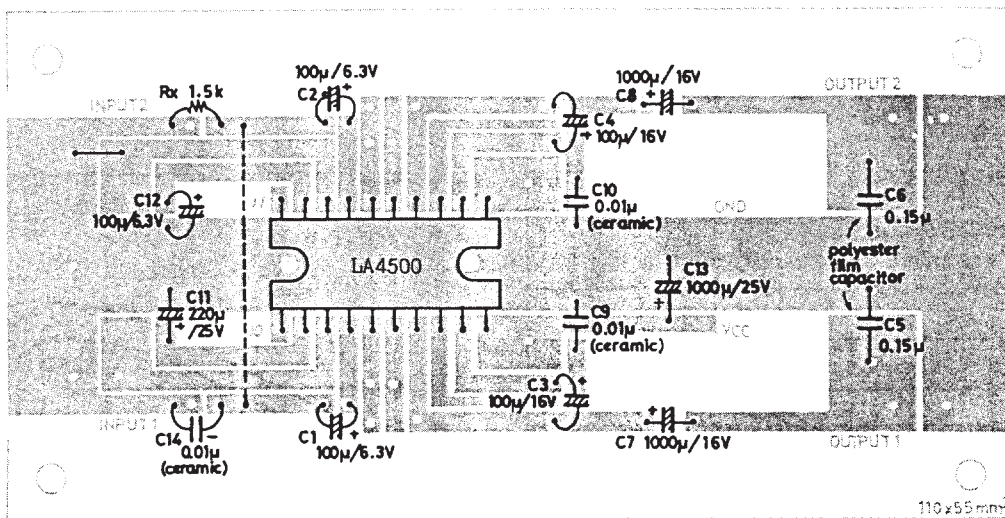
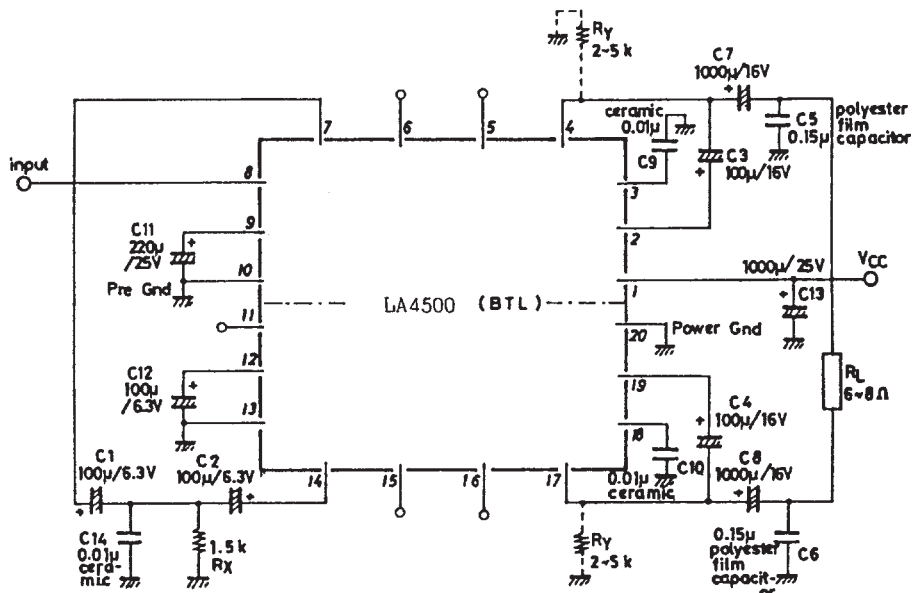

# LA4500

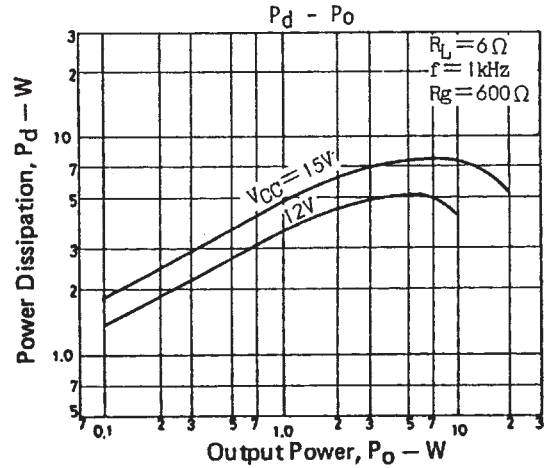
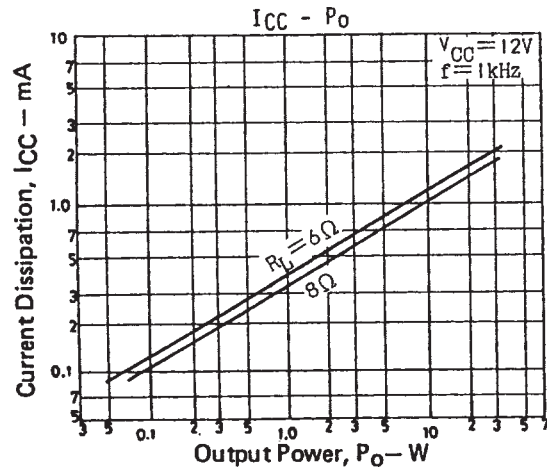
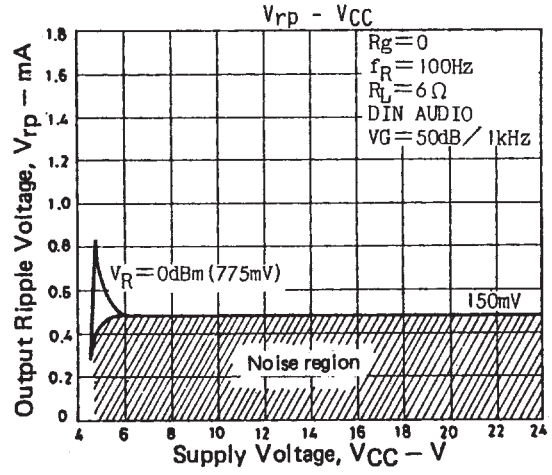
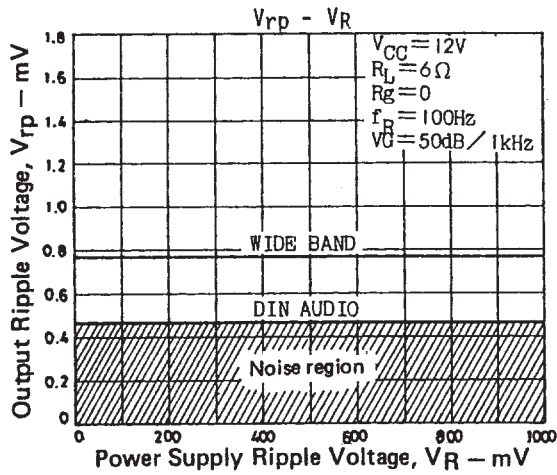
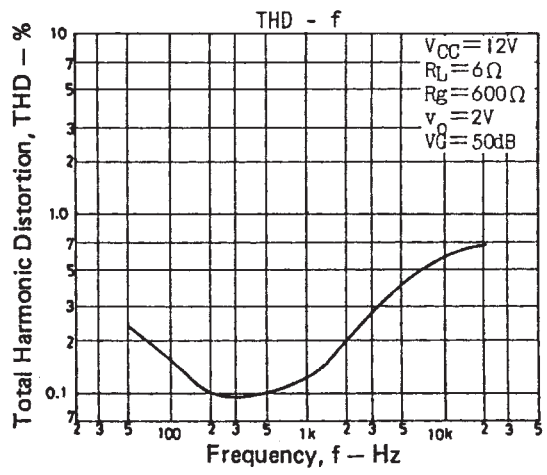
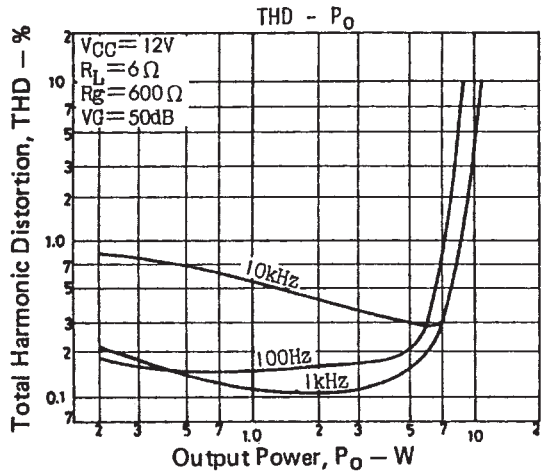
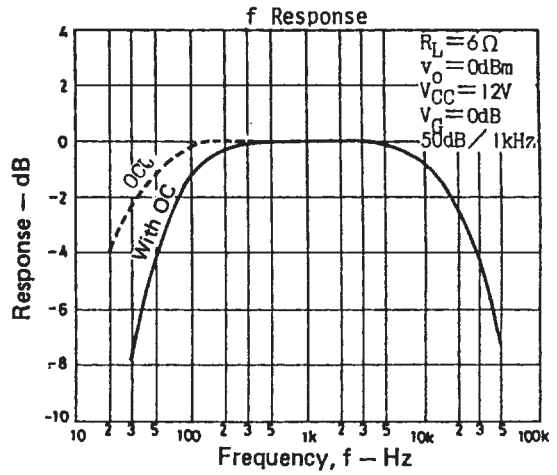
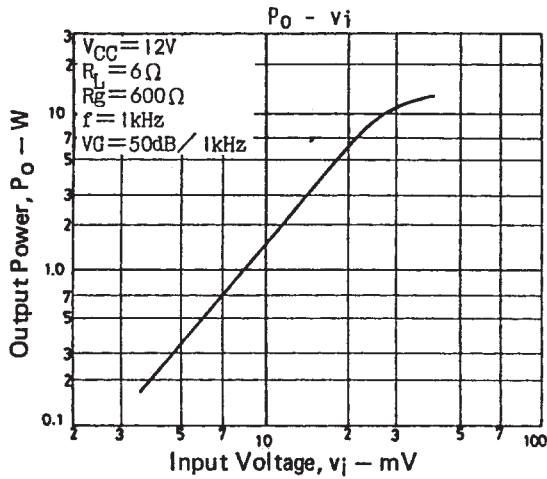

# LA4500

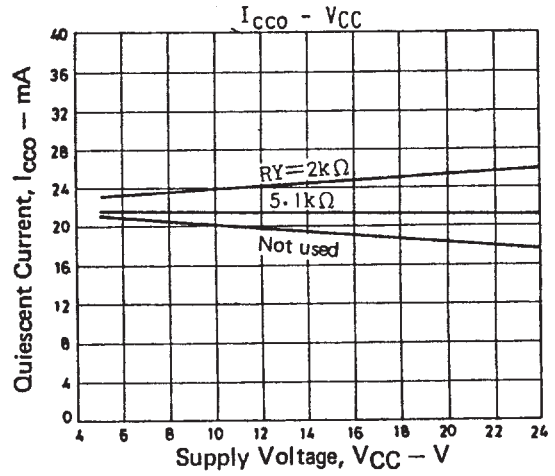
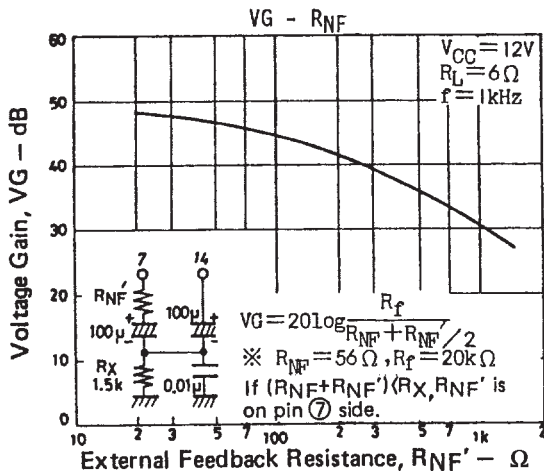
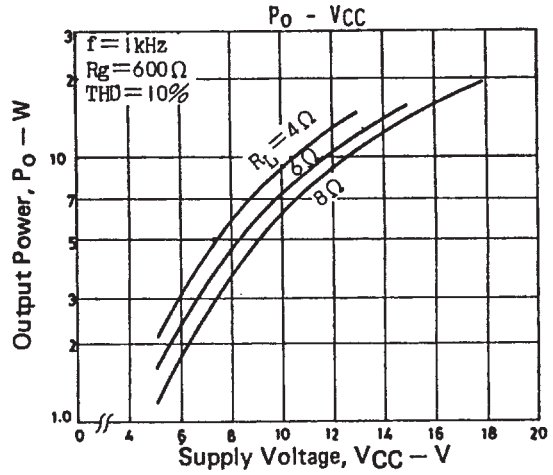
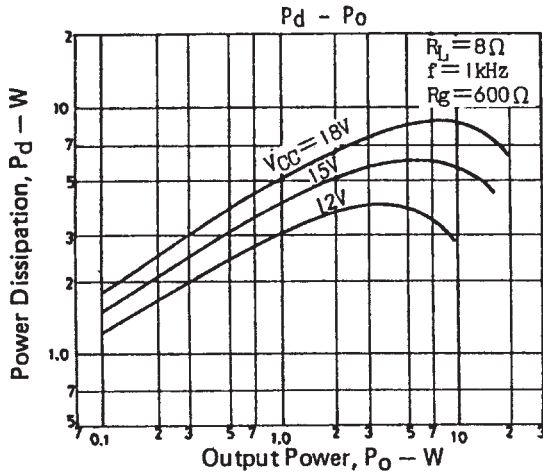

Output power (reference value) corresponding to supply voltage and load resistance.

(THD=10%)

System	$R_L$	9V	12V	15V	18V
Stereo	8 $\Omega$	1.4W	2.5W	4.0W	5.6W
	6 $\Omega$	1.8W	3.2W	5.0W	7.4W
	4 $\Omega$	2.4W	4.5W	6.9W	9.8W
	3 $\Omega$	3.0W	5.3W	7.8W	-
	2 $\Omega$	3.5W	-	-	-
Bridge	8 $\Omega$	4.5W	8.5W	13W	18W
	6 $\Omega$	5.5W	9.5W	15W	-
	4 $\Omega$	7.0W	-	-	-

## Proper Cares in Using IC

- Maximum ratings  
If the IC is used in the vicinity of the maximum ratings, even a slight variation in conditions may cause the maximum ratings to be exceeded, thereby leading to breakdown. Allow an ample margin of variation for supply voltage, etc. and use the IC in the range where the maximum ratings are not exceeded.
- Load short  
If the IC is operated with the short loaded for a long time, breakdown or deterioration may take place. Be sure not to short the load.
- Printed circuit board  
When drawing the printed circuit pattern, refer to the sample printed circuit pattern. Be careful not to form a feedback loop between input and output. Make the GND line thick and short so that no common resistance exists between Pre GND and Power GND.
- When using the IC in radios or radio-cassette tape recorders, allow a good distance between IC and ber antenna. An especially effective measure against radiation to the SW band is to additionally connect a capacitor of 0.033 $\mu$ F (polyester film capacitor) across pins (2) and (20) and across pins (19) and (20) respectively.
- Normally connect the heat sink of the package to GND.

## Proper Cares in Mounqing Radiator Fin

1. The mounting torque is in the range of 39 to 59N · cm.
2. The distance between screw holes of the radiator fin must coincide with the distance between screw holes of the IC. With case outline dimensions L and R referred to, the screws must be tightened with the distance between them as close to each other as possible.
3. The screw to be used must have a head equivalent to the one of truss machine screw or binder machine screw defined by JIS. Washers must also be used to protect the IC case.
4. No foreign matter such as cutting particles shall exist between heat sink and radiator fin. When applying grease on the junction surface, it must be applied uniformly on the whole surface.
5. IC lead pins are soldered to the printed circuit board after the radiator fin is mounted on the IC.

- Specifications of any and all SANYO products described or contained herein stipulate the performance, characteristics, and functions of the described products in the independent state, and are not guarantees of the performance, characteristics, and functions of the described products as mounted in the customer's products or equipment. To verify symptoms and states that cannot be evaluated in an independent device, the customer should always evaluate and test devices mounted in the customer's products or equipment.
- SANYO Electric Co., Ltd. strives to supply high-quality high-reliability products. However, any and all semiconductor products fail with some probability. It is possible that these probabilistic failures could give rise to accidents or events that could endanger human lives, that could give rise to smoke or fire, or that could cause damage to other property. When designing equipment, adopt safety measures so that these kinds of accidents or events cannot occur. Such measures include but are not limited to protective circuits and error prevention circuits for safe design, redundant design, and structural design.
- In the event that any or all SANYO products(including technical data, services) described or contained herein are controlled under any of applicable local export control laws and regulations, such products must not be exported without obtaining the export license from the authorities concerned in accordance with the above law.
- No part of this publication may be reproduced or transmitted in any form or by any means, electronic or mechanical, including photocopying and recording, or any information storage or retrieval system, or otherwise, without the prior written permission of SANYO Electric Co., Ltd.
- Any and all information described or contained herein are subject to change without notice due to product/technology improvement, etc. When designing equipment, refer to the "Delivery Specification" for the SANYO product that you intend to use.
- Information (including circuit diagrams and circuit parameters) herein is for example only ; it is not guaranteed for volume production. SANYO believes information herein is accurate and reliable, but no guarantees are made or implied regarding its use or any infringements of intellectual property rights or other rights of third parties.

This catalog provides information as of February, 2000. Specifications and information herein are subject to change without notice.